

Enriching production

Perspectives on Volvo's Uddevalla plant
as an alternative to lean production

ÅKE SANDBERG, Editor
Swedish Institute for Work Life Research
Stockholm, Sweden

Digital edition

Stockholm 2007

With a new preface by Åke Sandberg, National Institute for Working Life,
and KTH Royal Institute of Technology, Stockholm.

E-mail ake.sandberg@gmail.com or akesan@kth.se

Avebury

Aldershot • Brookfield USA • Hong Kong • Singapore • Sydney

Digital edition

© Å. Sandberg and the authors 2007

Printed edition

© Å. Sandberg and the authors 1994

All rights reserved. No part of this publication may be reproduced, stored in a retrieval system, or transmitted in any form or by any means, electronic, mechanical, photocopying, recording or otherwise without the prior permission of the publisher.

Published by
Avebury
Ashgate Publishing Limited
Gower House
Croft Road
Aldershot
Hants GU11 3HR
England

Ashgate Publishing Company
Old Post Road
Brookfield
Vermont 05036
USA

A CIP catalogue record for this book is available from
the British Library and the US Library of Congress.

Typeset by
Axel Henriksson, Datadromeda
for Newman Information Design AB
Maria Bangata 6
S-118 63 Stockholm
Sweden

ISBN 1 85972 106 0

Contents

Preface	vii
The book and its authors	ix
The Uddevalla experience in perspective, <i>Åke Sandberg</i>	1

Part I

Volvo's innovative Uddevalla and Kalmar plants

The creation of a new production system at the Volvo automobile assembly plant in Uddevalla, Sweden, <i>Kajsa Ellegård</i>	37
Production system design – a brief summary of some Swedish design efforts, <i>Tomas Engström and Lars Medbo</i>	61
The Uddevalla plant: Why did it succeed with a holistic approach and why did it come to an end? <i>Lennart Nilsson</i>	75
Volvo Kalmar – twice a pioneer, <i>Thomas Sandberg</i>	87

Part II

The performance of the Uddevalla plant in a comparative perspective

The fate of the branch plants – performance versus power, <i>Christian Berggren</i>	105
Assembly skills, process engineering and engineering design, <i>Henrik Blomgren and Bo Karlson</i>	127
Building for new production concepts, <i>Colin Clipson, Jesper Steen, Anders Törnqvist and Peter Ullmark</i>	137

Designed for learning: A tale of two auto plants, <i>Paul S. Adler and Robert E. Cole</i>	157
Limits to innovation in work organization?, <i>Bob Hancké and Saul Rubinstein</i>	179
Group work and the reception of Uddevalla in German car industry, <i>Ulrich Jürgens</i>	199

Part III

Volvo car plants internationally and the alliance with Renault

Volvo truck and bus in the UK: The clash of the Titans, <i>Paul Thompson and Terry Wallace</i>	217
Volvo-Gent: A Japanese transplant in Belgium or beyond? <i>Rik Huys and Geert Van Hootegem</i>	231
First DAF, then Volvo and now Mitsubishi, <i>Ben Dankbaar</i>	249
Missing the road: Working life at Volvo Nova Scotia, <i>L. Anders Sandberg</i>	269
Volvo in Malaysia, <i>Hing Ai Yun</i>	283
The origins of team work at Renault, <i>Michel Freyssenet</i>	293
Fait accompli? A Machiavellian interpretation of the Renault–Volvo merger, <i>Karel Williams, Colin Haslam and Sukhdev Johal</i>	309

Part IV

Beyond lean production

Japanese work policy: Opportunity, challenge or threat? <i>Norbert Altmann</i>	329
Lean production in the automobile industry: Second thoughts, <i>Dan Jonsson</i>	367
Humanization of the production system and work at Toyota Motor Co and Toyota Motor Kyushu, <i>Koichi Shimizu</i>	383
Recent developments at Toyota Motor Co, <i>Terje Grønning</i>	403
Social preconditions for lean management and its further development, <i>Paul Lillrank</i>	427
Lean production. The Micro-Macro dimension, employment and the welfare state, <i>Peter Auer</i>	437

Preface to the Digital Edition 2007

The innovative, productive and humane Volvo Kalmar and Uddevalla plants, with various concepts of group work, were closed in 1994 and 1993 respectively. Times were changing. Unemployment was rising; unions were focussing more on job creation and employment than on quality of work. Globalization put pressure on homogenization of production processes. Volvo got a new top management, after Pehr G. Gyllenhammar who had conceived the new factories in cooperation with unions. The bestselling book 'Lean production' (Womack et al) articulated and reinforced the ideology that there is just one best way and that no viable alternatives exist.

Today the Kalmar plant is rented as a warehouse, and for ICT production. In the Uddevalla plant Pininfarina with 800–900 employees produces a Volvo convertible using a product flow assembly system. In the other half of the plant Volvo Bus is welding space frames.

But ideas of competitive and human-centred forms of industrial production are still alive and they are practiced in various sectors. The Volvo Kalmar and Uddevalla production concepts are still used, by academics and practitioners alike, as reference points and as reminders of the possibility of alternatives with quality in both work and products.

The print editions of *Enriching Production* were quickly sold out. In January 2007, as a result of the centre-right government's decision to close Arbetslivsinstitutet/ Swedish National Institute for Working Life, we are organizing our archives and we found discs with the book. As there is still a demand we decided to prepare a digital edition, with no changes in the text, except this preface. Many thanks to Lena Karlsson for digital editing.

Enriching Production was followed by a workshop and a special issue on 'Good work and productivity', in *Economic and Industrial Democracy*, Vol. 19, No 1, 1998.

An indication of the topicality is a recent interview with Pehr G. Gyllenhammar in *LO-tidningen*, the journal of the Swedish Trade Union Confederation (Sept. 15, 2006). Gyllenhammar expresses an understanding for strikes in industry after 1968, and he states that 'companies must use the full potential of the employees, and the competitive advantage of good education, professional skills and an advanced form of work organization'. The basic idea is the same as when the Kalmar plant was planned 30 years ago, Gyllenhammar says: 'Why should it be so damned boring to assemble a car, when everybody loves to repair and tinker about with the same car in their spare time? It should be the other way around, delight and pride in producing the car.'

Stockholm in January 2007
Åke Sandberg

Preface

The background to this book is the closure of Volvo's car assembly plant in Uddevalla in western Sweden. The fate of the plant, being a symbol for human-centred production, was debated by policy-makers and researchers around the world. The Swedish Institute for Work Life Research decided that the experiences of the plant should be gathered in a book with an international and comparative perspective.

Cecilia Runnström has assisted me in the editorial work, and her work has been important for the realization of this book project. Fern Scott edited the English of all the chapters; also Aina Godenius and Ann-Britt Hellmark contributed here. Gary Newman and Axel Henriksson prepared the camera-ready copy. At the Institute director Anders L. Johansson and prof. Casten von Otter supported our work on the book during the whole process, and Iris Frank and Gudrun Hagberg helped with administrative tasks. Thank you all.

Postscript. January 1995

As this book was on its way to the printers, Volvo announced its intention to develop convertible and coupe versions of its 850 model in cooperation with the British TWR and to produce them in the Uddevalla plant, applying its unique production concept. This is good news; the Uddevalla concept of teams assembling whole cars may be further developed and get a chance to show its potential in car production which, as suggested in this book, is increasingly consumer oriented.

On the other hand, for production in longer series at the Swedish Torslanda plant and at the Belgian Gent plant, Volvo has made the choice of another production concept: preassembly of modules (often with long job cycles) to be finally assembled on a line with a high degree of automation. As researchers argued in the debate, Volvo in fact not only made a reduction in capacity, but a strategic choice of production concept basically different from that of Uddevalla. But with the Uddevalla plant again as a point of reference, possibilities grow of developing human-oriented and productive production concepts, 'enriching production', also adapted for production in long series.

There is not, as the authors on 'lean production' want us to believe, one single best work organization model. In the changing realities of industrial production, Uddevalla's 'enriching production' remains an important contribution to future developments.

Åke Sandberg

The book and its authors

This book discusses a pathbreaking effort to unite good jobs with productivity in industry – Volvo’s innovative Uddevalla car assembly plant where competent workers in groups built complete cars during a short period of four years.

The assembly line was not only broken, it was totally abandoned and the groups all worked in parallel independently of each other. The skilled workers were supported by advanced computer technology to guide the vehicles transporting components to the groups. Each car produced was destined to one specified customer. The plant started operation in 1989 and three years later the decision was made to close it down – together with the older Kalmar plant, the pioneer in breaking with line production. The authors of the book, a wide range of distinguished scholars of the field, analyze this experience in an international and comparative perspective.

Enriching production

The double goal of good jobs and productivity is the essence of what we want to call *enriching production*. Production that is enriching to work and workers and to investors and owners.

Lean production can never be the ultimate goal and form for human productive activity. Some ‘fat’ is needed to make the workplace a decent place for human activity, a place where you can unfold as a human being.

The concept of *enriching production* has grown out of work with this book. The study of Volvo’s Uddevalla plant, visits to the most advanced Japanese plants and discussions with colleagues, managers and trade unionists at home and abroad helped shaping the contours of a necessary alternative to the lean production concept.

We do not, like the authors of *The Machine that Changed the World* pretend that we have *the* solution for all types of production in all countries. But we

think we have a contribution to make to those interested in the possibility of high quality jobs, that are at the same time productive.

The chapters of the book and the authors

Below follows a short presentation of each chapter and of the authors.

The *introductory chapter* by Åke Sandberg, associate professor at Institutet för arbetslivsforskning (the Swedish Institute for Work Life Research), gives a background. Its focus is the Uddevalla plant – its rise and fall. The plant is put into an international comparative perspective. No one questions the uniqueness of the human side of the plant. Becoming also very productive, it was an example of *enriching production* in a double sense.

Part I

Kajsa Ellegård, associate professor at the Department of Human and Economic Geography at Göteborg University describes the development of the Uddevalla plant from the first ideas of conventional line assembly, to qualified workers building whole cars in a completely parallelized production. She followed and took part in the whole design and implementation process.

Tomas Engström and Lars Medbo played a major role in the design of the Uddevalla production concept. Engström is the associate professor and Medbo licenciate at the Department of transportation and logistics at Chalmers tekniska högskola in Göteborg (Chalmers University of Technology). They describe the ideas behind whole car assembly, the assembly- and human-oriented language to understand the functions of the car and the advanced logistics that make this model of car-building a radical step beyond Fordism.

Lennart Nilsson, associate professor at the Department of Education, Göteborg University, took part in the process of development of the Uddevalla concept focusing on holistic learning. His commitment is strong, and this is reflected in his chapter where he discusses the successful use of holistic learning principles in order to design the whole production process in Uddevalla. He also tries to understand why the potential of this concept was not fully realized and why the plant was closed.

Thomas Sandberg, associate professor at the Department of Business Administration, Uppsala University, tells the story of Volvo's Kalmar plant, from the 1970's until the 1990's. He focusses on recent developments. Assembly workers were involved in change processes. There was a focus on quality. By replacing the original carriers – one for each car – with so called taxi-carriers, dock assembly could be reintroduced with richer work content.

Indirect tasks like quality control and repair work have been integrated with assembly tasks.

Part II

Christian Berggren, researcher at the Institutet för arbetslivsforskning (the Swedish Institute for Work Life Research), and professor of industrial management at Linköping University, analyzes the impressive performance of the Uddevalla plant not only when it comes to assembly hours, but especially regarding customized cars with very short delivery time. Berggren criticizes Volvo's official justification of the closure and demonstrates the weaknesses of its calculation of cost savings.

Henrik Blomgren and Bo Karlson, doctoral student and PhD in engineering respectively, at the Department of industrial economics and management at the Kungliga tekniska högskolan (Royal Institute of Technology) in Stockholm give an illustrative example of the potential of the Uddevalla plant when it comes to product design and industrial engineering. Interaction between engineers and car builders with a high competence level may create exceptional conditions for a holistically oriented improvement process.

Colin Clipson, Jesper Steen, Anders Törnqvist and Peter Ullmark are all architects focussing on workplace design. Clipson is professor at the Architecture and planning research laboratory, University of Michigan, Ann Arbor, Törnqvist associate professor at the Department of industrial planning at Chalmers tekniska högskola in Göteborg (Chalmers University of Technology) and Steen and Ullmark associate professors at Industrial planning at the Kungliga tekniska högskolan (Royal Institute of Technology) and Steen and Ullmark associate professors at Industrial planning at the Kungliga tekniska högskolan (Royal Institute of Technology) in Stockholm. They analyze the design and layout of Volvo's Uddevalla plant. The relation between physical layout and the possibility for 'good jobs' and for flexibility in the organization of work is discussed.

Paul S. Adler and Robert E. Cole, professor of management, University of Southern California and professor of business administration and sociology, University of California, Berkley respectively, compare Volvo's Uddevalla plant and the Toyota-GM joint venture Nummi from the point of view of organizational learning. They argue that Nummi's version of Lean production is superior to Uddevalla's human-centred model when it comes to productivity and quality and that the quality of work life at Nummi is acceptable.

Bob Hancké and Saul Rubinstein compare the Uddevalla plant to GM's Saturn plant. They ask the question: How far can technological and organizational innovations go in 'insular settings', and what role does the wider corporate and industrial relations structure play in such innovation proc-

esses? They conclude that good economic performance of innovative plants is not enough to secure their future. Both authors are doctoral candidates at MIT, Hancké is a research fellow at Wissenschaftszentrum Berlin für Sozialforschung (the Science center Berlin for Social Research) and Rubinstein at the International Motor Vehicle Program.

Ulrich Jürgens, professor at Wissenschaftszentrum Berlin für Sozialforschung (the Science Center Berlin for Social Research), analyzes the recent German discussion about group work, human-centred production and lean production. In several plants stationary long cycle work was combined with modified line production, but basically the Uddevalla concept of whole-car assembly was seen as a linear extension of the job cycle rather than as a paradigmatic shift. Lately Uddevalla's closure has helped shift the balance towards Japan-oriented concepts.

Part III

Paul Thompson and Terry Wallace, discuss Volvo bus and truck production in the UK. They emphasize a 'market rules' perspective with a tendency towards line assembly for standard vehicles and dock assembly for special vehicles. This creates a repertoire of work organisation practices within the company. The authors see parallels between closures in Sweden and the UK. Thompson is professor of management at the Business Studies Department, Edinburgh University and Wallace is lecturer in Human Resource Management at Leeds Metropolitan University.

Rik Huys and Geert Van Hootegem, researcher and assistant respectively, at the Department of sociology of labour and organization, Katholieke Universiteit (Catholic University), Leuven, analyze recent improvements at the Belgian Gent factory – during many years regarded as Volvo's 'best practice' car plant. Team work with integration of certain control and repair tasks and at the same time short job cycles are current tendencies.

Ben Dankbaar, PhD and research director for the programme of 'Technology, work and organization' at MERIT, Limburg University, Maastricht, analyzes the stages in development of the Born plant, now a joint venture between the Dutch state, Volvo and Mitsubishi, the latter two now developing a common medium size car. Will the Mitsubishi variant of Japanese production concepts dominate or has Volvo still – after Uddevalla – a contribution to make?

L. Anders Sandberg, assistant professor at the Faculty of Environmental Studies, York University, discusses Volvo's assembly plant in Nova Scotia. He describes Nova Scotia as a peripheral region in Canada and sees the plant in light of concessions extended to Volvo; concessions are also expected from the work force, which is reflected in the work organization.

Hing Ai Yun, senior lecturer, Department of Sociology, National University of Singapore, discusses Volvo's presence in Malaysia. Like other foreign car producers Volvo established itself there because of different types of restrictions on car imports. She describes this background and the organization of work.

Michel Freyssenet, directeur de recherche at CNRS, IRESCO-CSU, Paris and GERPISA international network, discusses group work especially around automated segments of production and has later generalized this approach with substantial influence of Japanese concepts, keeping shortcycle, standardized tasks.

Karel Williams, Colin Haslam and Sukhdev Johal discuss the politics and business economics behind the alliance and planned merger (now dissolved) between Volvo and Renault. They give a Machiavellian interpretation. With internationalization of corporations they see, in concluding, risks for social dumping with the more generous social settlements like the Scandinavian welfare states being defeated by less ambitious welfare systems. Karel Williams is reader at the Department of Accounting, University of Manchester, Colin Haslam and Sukhdev Johal is reader and lecturer respectively, at the Business policy section, University of East London.

Part IV

Norbert Altmann, professor at the Institut für Sozialwissenschaftliche Forschung in München (Institute for Social Research) in an overview article describes, analyzes and criticizes social aspects of Japanese production concepts. His point of departure is *The Machine that Changed the World* and its neglect of consequences of lean production for employees and for the society as a whole and for individual enterprises and their productivity.

Dan Jonsson, associate professor at the Department of sociology, Göteborg University gives a methodological criticism of the best-selling book on lean production, *The Machine that Changed the World*. He reconstructs a casual model that makes explicit the ideas in the book that he analyzes, and he points at the weaknesses in the logical structure and the empirical validity.

Koichi Shimizu, professor of economics at the University of Okayama, has as a basic thesis that in the mid 1990s, when it appears that 'lean production' is being adopted by all automobile producers, Toyota has been reorganizing the very production system upon which 'lean production' is based. He sees a tendency towards humanization of work at Toyota. The background was recruitment problems and 'the crisis of work' but the tendency continues in spite of the recent recession.

Terje Grønning, lecturer, Institute of East European and Oriental Studies, University of Oslo, wrote his PhD thesis on the social organization of pro-

duction at Toyota and NUMMI while at the Sociology Department of Ritsumeikan University, Kyoto. His chapter focusses upon recent developments of the production system of Toyota and especially personnel administration practices such as subjective personnel assessment and wage systems.

Paul Lillrank, studied quality control in Japan while a researcher at the Science University of Tokyo. He is now an affiliated professor at the European Institute of Japanese Studies at the Stockholm School of Economics. His chapter tries to discern present tendencies towards post-lean management with more 'worker-friendly' work environment combined with automation.

Peter Auer, senior research fellow and head of project at the Wissenschaftszentrum Berlin für Sozialforschung (the Science Center Berlin for Social Research), looks at the micro-macro relation in lean production. He sees a risk that lean production in industry, with little room for social aspects, may lead to overwhelming pressures on state-financed social welfare. Corporate level lean production should perhaps allow for some fat in the production and be accompanied by macro level demand side politics.

The Uddevalla experience in perspective

Åke Sandberg

The focus of this book is the rise and fall of Volvo's Uddevalla plant on Sweden's west coast – a unique achievement in the history of car production and industrial production more generally. This pioneering example of social and technological innovation is discussed against the background of other Volvo establishments as well as international developments in car manufacturing. The Uddevalla plant was unique in its combination of good jobs and productivity. We would like to regard the plant as an example of 'enriching production', enriching to both work and workers and to investors and owners, benefitting by its productivity.

The Uddevalla plant was closed in 1993 after only four years of operation. The plant was outstanding in its human-centredness and the quality of work with groups building whole cars based on theories of holistic human learning. The plant also introduced advanced computer technology in logistics and planning in order to supply the teams with the components they needed to build a specific car in an efficient way. The plant was perhaps the most advanced in a long Scandinavian tradition of job redesign – often seen as a European alternative to Toyotism and lean production.

Although the focus here is on the Uddevalla plant, Volvo's Kalmar plant, created in the beginning of the 1970s deserves attention as well as a pioneer when it comes to breaking up the assembly line. It was closed in June 1994.

Toyotism – the end of history?

Does the closing of these two unique industrial design efforts signify the end of the road to a human and productive alternative in industrial production? An alternative that has been the focus of discussions in Swedish and German car production. Will we now see the dominance of lean production as the new 'best way' after Taylorism? Is Toyotism the end of history of industrial production?

This volume shows that a broad array of solutions and alternatives exist, and that the Uddevalla concept is one of the more remarkable among them. Not only are there cross country and cross company variations, but there are variations within companies and within countries as well. Volvo truck and car plants differ between countries like Sweden, Belgium and the UK, and within Sweden the same Volvo car was assembled in three plants with different production concepts. Toyota differs from Nissan. Although one can discern a more coherent concept or strategy within Toyota than within Volvo, the new Toyota plant in Kyushu island is different from the old ones. A similar kind of variation is true for other companies and countries.

The closing down of Uddevalla thus does not mean that only one way remains. With this book I hope we are able to show that Toyotism or 'lean production' as presented in the bestseller *The Machine that Changed the World* by Womack, Jones and Rose (1991), is not, as they seem to claim, the only possible industrial organization of the future.

Internationally, not least in the German case discussed by Ulrich Jürgens in his contribution, the impact of *The Machine that Changed the World*, and of Japanese production concepts is strong in the first half of the 1990s. In German car industry there was a relatively strong influence of Volvo's production concepts in the 1970s and 1980s. German work reformers how-ever did not accept the Uddevalla concept of stationary whole-car assembly, nor the idea of a qualitative difference between short cycle line assembly and group whole-car assembly with a several hours work cycle. Rather work reform was seen as a linear growth of work content both in subassembly of parts besides the line, and to a lesser extent along the line. Today we see a re-appraisal of the assembly line and a tendency to roll-back cycle times. Yet, according to Jürgens, there seems to be a belief in longer job cycles than the traditional short cycles.

German car industry is trying to integrate lean production features with human-centred features such as group autonomy. Pressure from Japanese solutions and competitors is tough. But national and historical preconditions of an economic, political and social character like type of product, industrial relations, labour markets (employment and qualification levels) and corporate and union strategy will influence the way workplaces transform (Turner and Auer, 1994).

Human-centred production is not at the end of the road but it will have to be transformed to include 'lean' elements to enhance productivity. Although productivity at Uddevalla was high by Swedish and European standards, it was not high enough compared to Japanese factories. Scandinavian and German work reform must now learn from Toyotism and lean production to focus even more on productivity while maintaining its human-centredness. International industrial relations and cooperation across borders concern-

ing social conditions of work will probably be important in determining the weight of human aspects in future industrial production.

The fate of Volvo's Uddevalla plant, its development and closure – situated in an international and comparative perspective – has a lot to teach us about those decisive issues. It presents us with a possible and radical alternative to lean production, an alternative that will be among remain in the focus in the future.

A view of Uddevalla

One episode that I myself experienced during a visit to Volvo's Uddevalla plant in the spring of 1993 demonstrates clearly the advanced customer orientation of the Uddevalla production model. Far from being disturbed by an 'intrusive observer', the members of an assembly team casually asked if I was a customer wanting to take part in the team's assembly of my car.

What I continued to observe at the plant further demonstrated the human orientation of the work being done. In a typical example, a group of nine workers assembled a car from beginning to end. They conferred with each other while working, resulting in the completion of the entire car before the morning coffee break. This team like all others in the plant had no supervisor. And the first level manager of this and the seven other teams in the product workshop, was on vacation; the groups could clearly manage their own work.

The closure decision

However Volvo was in economic difficulties and had too much capacity for the actual demand. In November of 1992, the Volvo board decided to close its car assembly plants in Kalmar and Uddevalla. Uddevalla was closed half a year later, and Kalmar followed suit in 1994. The plants had been heralded worldwide as symbols of a productive and human-oriented alternative in industrial management and work organization. Kalmar was the first car assembly plant to break up the traditional pattern of assembly line production. In Uddevalla the line was completely abolished with parallel groups assembling whole cars.

Mercedes-Benz director Edzard Reuter, expressed astonishment at the decision to close what he considered to be 'the most modern factories you have in Sweden'. Mercedes new Rastatt plant is partially built on principles similar to those of Uddevalla (Svenska Dagbladet, Nov. 6, 1992). A line with moving assembly platforms is combined with stationary workplaces for modular production with work cycles of up to two hours (Jürgens¹).

However, Peter Wickens, the personnel director of Nissan UK, regarded

the closure of the Swedish plants as an indication of the triumph of 'lean production' (Wickens 1993). To Peter Cressey (1993:89), who coordinates researcher networks on participation and work within the EC, the demise of the two plants represents 'potentially a seismic shift in the reference points that determine how to create the conditions for efficient production and collaborative social and design processes. In the car industry for instance, the choice has been between old fashioned Fordism, its newer variant "lean production" and the sociotechnical approach represented by these two plants.' Japan's industrial sociologists gathered for an annual conference in Fukuoka in 1992, were studying the Uddevalla plant, as an alternative to Japanese industrial organization.

The Kalmar and Uddevalla plants have been used widely as models in academic courses on job design. They have also served as reference points and examples in trade union programmes and training in many countries. Unions within Renault, the alliance partner of Volvo until the autumn of 1993, are but one example.

Disappointment concerning the closure decision seemed to be felt in many quarters. This was shown in the public debate that resulted in Sweden. This book is an attempt to contribute to preserving the experiences gained from Uddevalla, in terms of the innovations made in both human and industrial fronts².

In this first chapter I will introduce the reader to the Uddevalla experience and its background. In doing so, I will refer to other chapters, while contributing my own understanding of this experience, based on interviews and visits to Uddevalla, Renault and to some Japanese plants.

I intend to show that the closure of Kalmar and Uddevalla was not an inevitable outcome of the performance of these plants. In terms of productivity and quality they were on the same level as, and according to some evaluations they even out-performed Volvo's main Swedish assembly plant in Torslanda, Gothenburg. However they were small and perhaps diverging elements in a wider long-term production strategy within the Volvo-Renault alliance still in development at that time. The decision seems to be based not on local performance but on a global production strategy.

The design of the Uddevalla plant

The process of designing the Uddevalla plant began in 1985. In 1989 the factory was opened, as the result of a long process of active cooperation between Volvo management and engineers, unions (both local and national) and researchers. This was a pet project of the socially and humanistically oriented general manager of Volvo, Pehr G. Gyllenhammar. The academics provided a long research tradition of parallelization of production and of

long cycle-time work, as a way of achieving high productivity, quality and flexibility. Volvo's top management and the unions stressed quality of work as a high value and also as a way to secure recruitment of competent workers to assure productivity. An important background to the whole project was the labour market situation in Sweden at the time with almost full employment which meant recruitment problems for industry.

A visitor to Uddevalla, during its time of operation, would immediately note that production was on a relatively small scale. There is one central building and two clover-leaf structures with three plus three smaller buildings. The central building contains materials and components. Each leaf in the clover is built for one product workshop consisting of eight production groups with seven to ten workers in each; each group builds whole cars.

The Uddevalla model is similar to that of 'lean production' in its efforts to achieve customer orientation, quick delivery, as well as worker involvement and learning. However, the means to achieve the ends are different. What was so special about the Uddevalla plant, one could ask. This will be discussed in detail, in chapters written by some of the researchers that were involved in the design of the plant, of what they call 'reflective production' (see Ellegård, Engström and Medbo, and Nilsson; also Ellegård et al., 1992).

From a production design research point of view, two problems in highly parallelized production had to be solved. Traditionally, it was presumed that the learning capacity of assembly workers is no more than a few minutes of work content. In contrast to this principle of additive learning, holistic learning clearly argues that if the entire working activity is meaningful, then the capacity to learn during work is very high (Nilsson, 1985). A training workshop in Uddevalla had begun operation in 1986 which uniquely instigated the theoretical principles for holistic learning and parallel production technology into practice.

Learning capacity is also related to a second problem, which is how to supply materials in this type of production. In experimental workshops, products were disassembled and analyzed, making it possible to develop a formal representation and language with information about components that were organized according to the functions of the car (like doors and trim). This was done in a way that was meaningful and efficient in the long-cycle assembly work. These studies formed the basis of the sophisticated computer software which controlled materials supplied to each team while building a specific car (see Engström and Medbo).

From 700 workers on a line to 9 in a group

The development of the Uddevalla plant was a long process. It grew from the original idea of a factory where each of approximately 700 persons

contributed their task in a job cycle of two minutes, to the final idea of a factory where 48 small, parallel stationary teams assemble whole cars with a job cycle of around two hours (Ellegård describes this trajectory). The low horizontal division of labour, corresponded to a decentralized organization. It addressed issues such as quality, production technology, personnel, and tools, each type of issue handled by a team member with special training and with a rotating role as team representative. Eight teams of approximately 80 workers comprised a product shop with a shop manager as the first level in the hierarchy. Each team member could hold a maximum of two of the above specialities concurrently, thereby dispersing competence as well as salary, as workers received extra pay for the special functions, including team representative, that they held. This sophisticated design is far from the neocraftmanship nostalgia that Womack et al., (1991, p. 101) refer to.

Why did the Uddevalla design process result in this radical solution (Ellegård)? In the mid 1980s Volvo needed to expand its production capacity although the labour market was tight. The Metal workers' union wanted to try out their ideas of 'good work'. The experiences of the Kalmar plant were good in terms of productivity, but also image and publicity. Therefore a proposal to unite productivity and 'good work', was in line with the Volvo trajectory, as were efforts to further develop union and management cooperation.

More broadly stated, by the 1970s industry was already experiencing recruitment problems; absenteeism and turnover soared and wildcat strikes were common. Volvo responded by building its Kalmar factory. In the 1980s Uddevalla was built with a similar labour market background. At the same time, assembly of more complex customized vehicles made dependence on the workforce stronger. Product- and production-driven upmarket change was probably a more important factor than previously in the 1970s. Ever since their programme 'New factories' around 1970 the Swedish Employers' Confederation (SAF) had a network furthering group work as part of a strategy of 'coordinated independence', that is decentralization to product workshops and profit centres under central management control. During the 1980s however, the union side, especially the Metal workers' union developed their own proactive ideas on the 'good jobs' implying 'ladders of development' for job content and wages at the same time. This was also part of an effort to get some union control over wage determination processes that employers tried to decentralize as much as possible, keeping unions out.

The Volvo trajectory

Before returning to Uddevalla, its performance and its closure, a short sketch will be made of the Volvo trajectory of development of alternatives to line production based on Berggren's (1993a) study of the company. This

will provide a background and situate Uddevalla in the company context. There is also a chapter by Thomas Sandberg on Volvo's Kalmar plant, but unfortunately we were not able to include a separate chapter on the Torslanda plant.

Volvo plants are characterized by a diversity of both technical and organizational concepts. This variety reflects both market conditions for different product lines and social and labour market conditions in countries where Volvo production is located.

Transformations of work organization were more encompassing in Volvo than were those in Saab, the other Swedish car-maker which faced similar market conditions. Berggren ascribes this partially to the 'Volvo culture' with long time CEO, and later board chairman Pehr G. Gyllenhammar's interest in new production concepts; the close cooperation with the trade unions; and the openmindedness among Volvo engineers, although there were those both in management and unions that were in favour of traditional production concepts. However the Volvo culture was not the decisive factor. Social conditions in different countries lead to different solutions and Berggren concludes: There is no 'Volvoism'.

In Sweden we find the following conditions: Union membership was high. The high employment levels of the 1970s remained in the 1980's, with an unemployment level mostly below 3 percent. Labour force participation was high. Wage differences were small, and the social benefit system was uniform across the labour market. Therefore, tough working conditions could not be compensated for with higher wages, or attractive social benefits. Such social and labour market characteristics together may be seen as 'selective disadvantages' for production (Porter, 1990).

Furthermore, the product strategy of the Swedish auto producers was to move towards demanding upmarket product segments. Product variation increased and the dependence on foreign sales contributed to the need for adaptation to different customer demands.

Sweden faced combined pressures from the product market and the labour market which forced companies to be innovative in human-centred directions, especially in labour-intensive assembly. (Berggren 1993a; see also Streek, 1987 and Sandberg et al., 1992). Flexible quality production demands a stable workforce, and a high employment level made it difficult to recruit and keep workers for Taylorized jobs. Volvo trucks for example, followed different production strategies. In Belgium with an abundant labour supply (an unemployment level of around 10 percent in the Gent region) and a lower level of job security, Volvo invested in assembly lines for simpler products. Whereas in Sweden, with a more demanding labour force, Volvo invested in flexible, holistic forms of production of complex and customized vehicles.

If we now move to the examples of the Volvo trajectory in Sweden we find that although Kalmar and Uddevalla were the symbols of the Volvo trajectory of alternatives to the assembly line, some of Volvo's human-centred solutions have survived in its engine and truck plants.³

In Volvo's Kalmar car assembly plant, established in 1974, twenty teams worked with objects transported on automatically guided vehicles (AGVs), in a series connected flow divided by buffers. There were four to five stations in a team area, where the object could move from station to station. But the team could also perform its work on stationary carriers at 'docks'. The restriction was however, that the sequence of objects had to be maintained which created stress for the workers or disorder in production, whenever an object was removed from the central flow. With more model options the problems grew. Management's focus towards the mid-1980s had changed from employee motivation to using the elastic technical system to rationalize and raise work intensity. Gradually Kalmar became Volvo's best Swedish car plant, in terms of assembly hours and quality. In the beginning of the 1990s there was a revival of long job cycles and dock assembly in new forms, based upon new so called taxi-carriers, replacing the centrally controlled AGVs.

Volvo's truck plant in Tuve outside Gothenburg was opened in 1981. It was built as a compromise between line and integrated assembly in groups. There were buffers between groups which gave them some control over work pace. More important than the production design changes were, however, the organizational changes. Groups could influence everyday decisions, such as the distribution of tasks and short leave periods, and a rotating role as group representative replaced foremen and quality inspectors. With higher output and a more complex product programme, buffers tended, like in Kalmar, to be transformed into workplaces. The series link created quality problems as groups had to release unfinished vehicles. As a result personnel turnover soared. Management strengthened shop-floor supervision and at the same time, started a two-step dock assembly for the most complex products. – The ways in which the introduction of dock assembly in Volvo truck and bus plants abroad depends on market conditions, is a theme in the contribution by Paul Thompson and Terry Wallace.

At the Torslanda volume car plant in Gothenburg, inaugurated in 1964, Volvo tried different strategies over the years to improve productivity and motivation. These strategies included attitude campaigns, organizational experiments and mechanization, which were all based on continued line manufacturing and all proved insufficient. In 1986, a reorganization project returned to an earlier idea of gradually replacing the assembly line with a more flexible transport system between workshops. This meant producing parts of a car with group work and varying degrees of parallelization, thus combining line and dock principles. This created problems with the flow,

such as those in the cases above. In 1989, a new project proposed the installation of three shops for building whole cars similar to the Uddevalla concept. At the same time line assembly was to continue for the majority of the cars. An initial whole car shop was soon abandoned as it represented an alien body in what may be called a predominantly Fordist culture. The plant swung back to more traditional solutions. (On Torslanda compared to Uddevalla see also Granath, 1991.)

Volvo has announced that an Uddevalla type production facility of a limited scale is being installed in the Torslanda plant for production of special cars like ambulances and police cars. For these types of vehicles, the Uddevalla production system has proven to be drastically more efficient than line production. In Uddevalla, police cars were built from scratch using fewer man hours than were needed in Gothenburg to strip a standard car and convert it into a police car. To the number of hours in the Gothenburg case, should be added the hours for first assembling the standard car.

We have seen several examples of efforts to replace, partially and gradually, line production with more holistic alternatives. We have also seen different problems for such combined solutions and occasionally a return to conventional solutions. It remains to be seen whether the gradual transformation of the lines in Torslanda that is now on its way will overcome these types of problems. The transformation includes more developed pre-assembly, ergonomics and automation.

In contrast to the situation in Torslanda around 1990, the Uddevalla project after two years of work came up with an alternative to line production. The solution was, as we have seen, a fortyeight-fold parallelization, with each team making a complete car. Assembly jobs were based on the different functions of the car (like doors, drive line, interior), rather than on balancing of time along a line. A language was developed with proper meaningful names in order to facilitate assembly of different variants, learning and communication. Part numbers like 25792, 22367 and 15178 were replaced by correct names like brake cylinder, brake leads and brake pedal.

Uddevalla performance

A look at the performance of the Uddevalla plant itself will make it difficult to understand the closing-down.⁴ Comparing measures of productivity for Torslanda and Uddevalla gives the following picture. (The Volvo plant in Gent had better performance than the Swedish plants.)

Assembly-time in Torslanda in October 1992 was 42 hours per car and in Uddevalla 32.8 work-hours, to which 6 hours of white-collar work should be added. Productivity measures like these are difficult to compare, but indicate that Uddevalla and Torslanda were roughly on the same level. One

indication of the potential of the Uddevalla production system is the fact that several workers assembled whole cars in less than 20 hours. One of the workers there managed to build a whole car in just 10 hours, plus a few hours for materials handling etc. (Metallarbetaren, 1993).

The *quality* of the cars assembled at Uddevalla was at least as high as that of Gothenburg, both measured as number of defects per car (6 versus 7 respectively) and according to the internationally renowned J. D. Powers customer survey. Kalmar's quality however, was the best among the three Swedish plants.

In the autumn of 1992, Uddevalla's *total lead time* for delivery, from the individual customer order, was down to four weeks, and a further reduction down to two weeks was planned for the first half year of 1993. Customers could make changes in the specification as late as three days before assembly. One explanation for this flexibility was Uddevalla's highly parallelized production system, which provides no balancing problems and no need for a fixed product mix. Customized production and short lead times, means higher sales prices and virtually no cost for finished car stock.

Uddevalla needed less investments in *tools and equipment* than did the Gothenburg plant. For example, due to long job cycles the number of jigs needed is reduced, as one operator finishes a whole task rather than the task being divided among several workers, each one needing one jig.

Model changes in Uddevalla needed less time and less costs in tools and training than did the Gothenburg plant. The explanation is low-tech simple tools and the workers' high competence level, which facilitates the rapid learning of new tasks.

The new design principles allow reductions in both *space* requirements and technical *production support* to the work groups (see Engström and Medbo). Furthermore, Uddevalla assemblers discovered design problems that neither assemblers nor process engineers at Torslanda were aware of (Blomgren and Karlson), thus providing a potential for a more active role for assemblers in the area of product development (also Ellegård).

Organizational learning

The overview of the Uddevalla plant's performance presents a positive picture. However, not all observers agree. The possibilities of organizational learning and continued development of performance in Uddevalla is questioned in the chapter by Robert Cole and Paul Adler. Basically, Adler and Cole argue that 'lean production' is the way to maximize organizational learning. Work tasks are specialized and standardized gesture-by-gesture, then strictly and identically implemented in the whole organization. This

standardization, is combined with worker involvement in the definition and improvement of the standard work procedures.

Adler and Cole write that one cannot systematically improve what has not been standardized. They challenge the German-Scandinavian 'human-centred' model, which implies that organizational learning is best served by long work cycles in teams with a high degree of autonomy. Using data from the International Motor Vehicle Programme (IMVP, which was summarized by Womack et al., 1991), they argue that Uddevalla assembly hours were somewhat lower than the average for European luxury producers, but far higher than Japanese luxury producers' average. Although Uddevalla's performance during the last year drastically improved, they doubt that mechanisms of improvement across the work groups were really put in place. They admit that an enormous improvement and 'crisis learning' took place, but they are not certain whether that learning could have continued. Adler and Cole found better performance rates in terms of assembly hours and product quality in the Toyota-GM joint venture, Nummi, than in Uddevalla.

Both Christian Berggren and Kajsa Ellegård in their contributions, as well as Uddevalla managers interviewed in the spring of 1993 admit there had been productivity problems in Uddevalla. They all emphasize, however, that much changed during Uddevalla's last year of operation. Although the primary goal for Uddevalla, during the first couple of years, was to develop functioning working procedures whereby each team would develop and utilize its own working model, at a later stage one was able to focus on the organization as a whole.

Changes were occurring on the managerial level to facilitate communication and learning in the whole organization and to focus management's attention on the total production process. Initially, the new plant manager flattened the hierarchy so that teams communicated directly with shop managers, who made up the bulk of the new management committee of the plant. The result was a flat organization with only three levels: worker, product shop manager, plant manager. Secondly, the plant manager planned to relocate all managers from the central office building to facilities close to the production process. The aesthetically elegant and symmetrical plant layout, with an office building radically separated from the workshops, may in fact have contributed to keeping integration of different personnel groups at a low level. It may also have prolonged the separation between conventional management and innovative shopfloor practices (see Clipson et al.). The closing-down decision prevented the implementation of this second step.

The first step, that of a flatter organization, was carried through. Shop managers began learning more about assembly, while other production engineers split their time between working in the teams and communicating with other teams. A Kaizen programme was successfully introduced

(Kaizen is the Japanese word for continuous improvement). As a result, team members visited other product shops to learn how they solved specific assembly problems. Consultants from the Kaizen institute, remarked on the extra ordinary willingness to rationalize at Uddevalla.

Ellegård and Berggren stress the radical and promising organizational changes, which took place during the last few months of operation in Uddevalla. They conclude that there were great possibilities for further organizational learning and that Uddevalla demonstrated the initiation of a promising learning curve.

Furthermore Lennart Nilsson is convinced of the productive potential of the Uddevalla concept. He strongly argues that after a succesful period of application of the principles of 'holistic learning' the return to more conventional ideas of 'additive learning' had a negative effect for the development of competence as well as for productivity. But during the last year he sees a renewed application of 'holistic learning principles' and a constructive development of the organization.

These positive views of Uddevalla's potential contrasts with Adler and Cole's doubt that performance would have continued to improve at the 'crisis learning' rate, much less at an accelerated learning rate. Adler and Cole pondered at the limits to organizational learning, and if they were intrinsic to the Uddevalla model or were external. They conclude: 'What we do know, and what we can all agree upon, is that it was a tragedy that the plant was closed and these questions will remain unanswered'.

If we draw the preliminary conclusion that Nummi was and would for some time remain a more efficient plant in terms of assembly hours, there are other relevant aspects to be included in a more complete comparison.

Beyond assembly hours

Beyond assembly hours, one should consider the commercial benefits of Uddevalla's quick delivery of the precise specifications requested by the dealer and customer. This results in a substantially higher sales price than for cars produced in more conventional plants according to prognoses of customer demand, like the Torslanda plant.

Considering human work, skills and autonomy, these aspects further point in favour of Uddevalla. Cole and Adler do conclude that Uddevalla provides more scope for the development of workers' human potential, but they situate Nummi's quality of work within the 'acceptable range'. However, in a plant of Nummi's type, although workers participate in Kaizen activities, the line exerts a strict control over the individuals' work procedures and work intensity.

The Uddevalla plant was, as already indicated, after only three years of

operation, at least on the same performance level as the more traditional plant in Gothenburg. The Kalmar plant – which would merit a book of its own – was even better, after drastic improvements in the 1990s.

Why then was Uddevalla closed? Volvo's official answer is low sales, losses and overcapacity. Therefore, they saw a need for capacity reductions. Volvo certainly had an overcapacity problem and preferred closing the smaller and uncomplete⁵ plants in Kalmar and Uddevalla, concentrating production to the larger Torslanda plant in Gothenburg. Closing smaller branch plants is a standard solution in overcapacity situations as Karel Williams and his colleagues underline (Williams et al.). There may thus have been good structural economic and policy reasons for closing Uddevalla and Kalmar. But to explain why these factories were closed and not others, Volvo presented a cost calculation, which under closer scrutiny does not support their claims. Practically all cost items in the calculation have been questioned. Figures much more in favour of Uddevalla (and even more so Kalmar), were presented in the public Swedish debate. For example Volvo regarded the transportation of bodies from Gothenburg to Uddevalla as an extra cost, but the debate showed that total costs for transportation of components were lower for Uddevalla than for Gothenburg.⁶ The revenues projected considering Uddevalla's potential for reduced bureaucracy and indirect costs, contributions to design, as well as customization, smaller stocks and higher prices all contribute to further challenging the calculation. There is therefore reason to doubt whether Volvo's calculations show the actual reasons behind the closure.

One aspect that was not raised in the calculations has to do with the issue of control. The productivity and learning in the Uddevalla concept, dependent to a large degree on the individuals and groups, could not be easily controlled by management. Whereas the Japanese concepts, as Ulrich Jürgens emphasizes in his contribution, seem to offer the possibility of a uniform and continuous process of improvement, one which is easier to control by management. As mentioned above however, during the very last months at Uddevalla there were efforts to secure more of plant-wide learning, and this could in turn have strengthened overall management control.

Perhaps to understand the closure one must look also to organizational politics and dominating ideas within Volvo.⁷

Organizational politics

One explanation of the decision to close Kalmar and Uddevalla, could be the 'battle of ideas' between traditionalists and innovators at Volvo. As early as 1989, one manager on Volvo Group level said that the 'Uddevalla experiment' was connected with Sweden's tight labour market and that if

Volvo moved its production to the Baltic States or to Southeast Asia, then the probable model would be Taylorism (Hammarén, 1989).

Over the years, the Volvo Group management and P. G. Gyllenhammar supported Uddevalla, but at the same time more conventional solutions were allowed to live on in other Volvo plants. Uddevalla played an innovative role. By many it was however regarded as an experiment to be closed in tougher times. Even within the Uddevalla project group, there were technicians with a more traditional view (see Ellegård). Similar examples of struggles between Volvo managers representing different production concepts could be seen in other parts of Volvo, such as the Skövde and Vara plants within the engine division. At a new engine plant in Skövde, sociotechnical solutions with group work, long work cycles and buffers were introduced. A follow-up study, seven years later, showed little sociotechnical renewal after the first year and signs of regression, as a few key personnel left and their replacements were frequently traditionalists trained in a different environment (Forslin, 1992).

Turning now towards the trade union side, one union reason for scepticism towards Uddevalla may have been that in contrast to MTM-based wages in line assembly, group work of the Uddevalla type could lead to an uncontrolled intensification of work, as well as a loss of trade union influence on the relation between wages and work performed.⁸ Torslanda and Gothenburg has the numerical advantage. It is also the 'cradle' of the company. In economically bad times, the Gothenburg unions had a need to defend the jobs remaining in Gothenburg.

In this context, it is interesting to compare Uddevalla and GM's Saturn plant, in terms of differences (such as type of car built) and similarities. As Hancké and Rubinstein explain in their chapter, both plants are relatively small operations in large corporations, and they are innovative and different. To understand the closing down of Uddevalla, they conclude, one has to regard the politics of both management and the union. Uddevalla did not have a winning coalition that backed it, but was dependent upon a parent corporation's willingness to pump money into its development. Furthermore, the Uddevalla local unions were dependent upon the Volvo Group level unions, in regard to access to strategic decision making bodies.

Renault and Volvo

As key decisions were made within Volvo, Renault was the partner in an alliance with Volvo aimed at close cooperation and finally merger, so it is relevant to look at the production organization at Renault and its possible influence on developments within Volvo. The relevance for the decisions that were made remains although the alliance was later dissolved. Also a

discussion of Renault is of interest, as an example of a major European car manufacturer and of Volvo's competitive market environment.

Within the sphere of work organization, those within Volvo opposing the Kalmar-Uddevalla trajectory are likely to have been strengthened by Renault's entry onto the scene. Interviewing Renault managers and consultants in the spring of 1993, one Renault manager expressed what he regarded as a common view, that although Uddevalla was seen as advanced in terms of work organization, Volvo's economic difficulties may be related to some of her plant's new production concepts and low volumes. In a similar vein, a consultant's report for the French government was very critical of the set-up in Kalmar and Uddevalla and concluded that their 'production model has reached its limits, and has no place in today's competitive context' (SRI, 1992). Thus, cooperation with Renault may have contributed to the decision to close these plants.

Discussing work organization philosophies with Renault representatives, they often distinguished between Taylorism, Scandinavian-type sociotechnical solutions and Toyota inspired production systems. As in many other countries, labour market pressure during the 1970s forced Renault to try sociotechnical experiments with substantial changes in division of labour and hierarchical relations. As Michel Freyssenet discusses in his contribution, such changes that endanger division of labour and assembly line production were disputed and often discontinued, but later group work was accepted by Renault management 'as soon as it was conceptually separated from a fundamental threat to flow-like production in the form of assembly lines or automated production lines'.

At the same time, ambitions of job enrichment and skill development continued and was maintained as one of the bases for an agreement that was concluded in 1989 between Renault and five trade unions, of which CFDT was the largest.

These unions represented a weak majority among employees. The communist oriented CGT, which represented just below fifty percent did not sign the 'Accord a vivre'. The agreement specified that work should be organized in Unités Elementaires de Travail (UET), elementary work units, comprising 10–20 workers under one supervisor responsible for their performance. It should be possible to identify the product of the UET and its principal 'suppliers' and 'clients' upstream and downstream within the production flow of the factory.⁹ The idea is that the group members should be multi-skilled, including such tasks as quality control, maintenance, problem solving etc. Yet, the work should remain based on assembly line technology. The CGT is critical towards the UET and the way they were introduced. Other unions raise the criticism regarding a risk that the UET become administrative units whose performance is controlled, but that little really happens when

it comes to work organization¹⁰. Whereas Renault unions regarded the Uddevalla production organization with great interest, personnel management of Renault, according to Michel Freyssenet's contribution, see the assembly line work as inevitable for economic reasons, but they emphasise that the nature of the line is changed due to subassembly besides the line and automation of heavy operations.

It is obvious that there is a basic difference between Renault's UETs and the work done at Uddevalla. Although both pride themselves in group work and worker competence, the assembly line with short job cycles versus parallelization and whole-car assembly are expressions of fundamentally different philosophies. Another basic difference is the emphasis on production workers' careers in Renault versus development of competence and wages while remaining on the same job in the group in Uddevalla¹¹. The need for interplant comparisons and the possibilities of moving production between units, that the alliance with Renault may have brought about, may have put pressure on the smaller Volvo to adapt its production technology and work organization. As further evidenced during the collapse of the alliance it was as a case of two production cultures colliding (see also Williams et al., Williams and Haslam, 1993 and Rickhamre, 1993).

The plant and its environment

Pioneers often face high costs of entry, as well as opposition to their ideas. Volvo cars have developed a plurality of different production concepts, which has meant substantial costs for research and for industrial engineering and production preparation. The overwhelming majority of car factories in the world are based on line production, which has allowed for a far reaching standardization of production technology. This makes development and use of alternatives costly, especially for a small company. The degree of congruence between an organization and its wider environment is thus crucial in the assessment of the innovative organization's future (Hancké and Rubinstein). This is true for Uddevalla within Volvo and for Saturn within GM. It was also true for Volvo, in relation to Renault and still for Volvo in relation to the car industry in general.¹²

The consequences of the alliance and planned merger with Renault may, in summary, be regarded in two perspectives. First, there may be good policy reasons, at least in the short and medium term, to close plants like Uddevalla and Kalmar that differ fundamentally in philosophy and layout from other Volvo and especially Renault assembly plants. Coordination of production networks and also ideological coherence, may be easier with a more streamlined set-up of plants. The second aspect is, as we have seen,

organizational politics, representing the struggle between different dominating ideas within the organization.

The reduction of volume, and for that reason antagonism between workplaces in the Volvo group, together with a change in management of the company and the entrance of Renault, could be seen as releasing factors for the shift in balance between opposing dominating ideas.¹³ An important background factor for the decision to close Uddevalla, is the suddenly high unemployment level in Sweden. This made the need for good jobs weaker. 'Crisis consciousness' was at a peak in Sweden in the autumn 1992, with an interest rate from the Bank of Sweden as high as 500 % and with 'crisis agreements' between government and opposition.

Uddevalla managers interviewed in the spring of 1993, were certain that it was a strategic mistake to close this plant, particularly due to its unique qualities in customer orientation, cooperation between design and production, and worker competence and motivation. Volvo representatives in the public debate, however maintained that the closure of Kalmar and Uddevalla was purely due to capacity reduction and not a strategic choice of production concepts¹⁴.

Corporate level support and commitment to the bold new plant and to its potential in terms of market aspects and human aspects were neither strong nor sustainable enough to allow this potential to develop and to be transferred to other parts of the company. In contrast, GM's Saturn plant, at least initially (Hancké and Rubinstein), had a strong support from corporate levels as a model for future production organization and industrial relations. A new car was developed to be produced in the new plant and the company proudly advertised the car referring to its human production mode. Volvo kept a low profile for the Uddevalla plant and no special vehicle was developed uniquely adapted to its assembly system. Without a corporate vision and positive strategy and support, excellent performance was not enough for the Uddevalla plant to prove it had a place on a crisis struck car market.

Trade union role

What has been the role of the trade unions? The newspaper of the Uddevalla region, Bohuslänningen, wrote of the protests of the unions in Uddevalla and the excellent performance development of the Uddevalla plant. In contrast the national business media spread a message inspired by Womack et al., of Uddevalla as a 'nightmare factory', and information from Volvo about drastically improved performance at the Gothenburg plant. The Volvo Group union organizations in Gothenburg and the national trade union organizations were quiet. The national Swedish Metal Workers' Union issued little public support of the plant, the creation of which was partially dependent

on its support in earlier critical stages. The union's silence contrasts with its pioneering and longstanding commitment to what it calls 'the good jobs' and 'solidaristic work policy'. The national union seemed to have difficulty in finding a role for itself in this situation of overcapacity, closure and conflict of interest between plants, and referred to the Gothenburg Volvo Group level union as the legitimate actor¹⁵. The latter union was already in a difficult position, as many auto jobs had already been lost in Gothenburg. (On the problematic union role see Berggren and Hancké and Rubinstein, and Sandberg, 1994.)

There seems to be a need for reexamining the mechanisms necessary for implementing a 'solidaristic work policy' and to work out the relations between different workplaces and union levels in this respect. This is a genuine dilemma for a democratic organization with elected bodies on several levels. Perhaps the national union could have engaged in the public debate emphasizing the unique qualities of the two plants as well as their symbolic value, at the same time as they allowed the workplace and group level unions (each one supported by their own consultants), to weigh different aspects against each other and make the final judgment.

We have thus far discussed the Uddevalla plant considering the Volvo trajectory in Sweden on the one hand, and the European car industry with a focus on the former alliance partner Renault, on the other hand. It is now time to widen the perspective to the Volvo car factories abroad covered in this book.

Volvo abroad

Although we have pointed to the existence of a specific Volvo trajectory with factories developing different alternatives to line assembly (many of them based on parallelization and advanced team work), we have concluded that there is no 'Volvoism', except for an unusual degree of pluralism, adapting to contingencies. This conclusion is underlined below in the overview of the cases of Volvo in the the Netherlands, UK, Belgium, Canada and Malaysia presented in chapters in this volume.

Between 1972 and 1975 Volvo was a minority owner of the car plant Born in the Netherlands. Between 1975 and 1981 however, it became the majority owner of this plant. Although Kalmar was opened in 1974, none of the Kalmar ideas were transferred to Born. Ben Dankbaar in his chapter concludes that: '... apparently there was little or no expectation that the new concepts would contribute to productivity in a situation where absenteeism and personnel turnover were less of a problem'. Later, from 1986 on, however, some experiments with longer job cycles were carried out. A few AGVs were introduced and there were some try-outs where complete bodies were

assembled by a small team. In both cases necessary changes in layout and equipment were considered too expensive to justify more general changes. Apart from these experiments, work cycles have been and continue to be between 30 and 60 seconds.

In addition to the labour market conditions emphasized in the Born case, the product market is one more factor to explain Volvo's choice of production concept and work design in different contexts. Thompson and Wallace, in their discussion of bus and truck production in the UK, regard the repertoire and choice of production concepts as a mirror of the company's strategic response to shifting market conditions.¹⁶ Given different circumstances, the repertoire may act as a resource for actors striving for different solutions. Within Volvo there is a plurality of concepts including some of the most advanced alternatives to assembly line production. These are then realized depending on the market conditions.

With the Belgian Gent factory in 1965, Volvo got closer to the EEC market. The plant, today, is based on assembly line technology. There are carriers in some sections of the line, but there is no dock assembly. In the mid 1970s, there was an experiment with workers assembling complete engines, with a cycle-time of 30 minutes. However this 'island' in the plant came to an end. Workers felt socially cut off from the production line and unions were not pleased with the experiment. The Uddevalla plant, in Belgian car industry as in the Dutch case, was looked upon as an answer to a Swedish problem of absenteeism, high educational level and low unemployment.

To increase flexibility, the Gent plant began implementing so called VEC-teams (Volvo Europe Car teams) in 1989, Rik Huys and Geert Van Hootegem report in their contribution. In the VEC teams, 8–12 workers are headed by one team leader, not chosen by the team members. Work stations are unchanged (with 86 seconds job cycle time), but workers must know at least three jobs for possible rotation. Additional team tasks concerning quality, maintenance and materials handling, are taken on by a team member, the position rotating among team members. An evaluation of the new team system will have to look at the extent to which operator jobs are significantly enriched or to which extent, the new tasks are mainly executed by the team leader.

Writing the history of Volvo's plant in Nova Scotia, Canada, Anders Sandberg concludes that Volvo did not bring 'a little bit of Sweden' to Nova Scotia. 'Instead, the company quickly adopted to and exploited the peripheral conditions of its new location.' Concessions were extended to Volvo and it is suggested that these concessions were also reflected in the work organization and the labour climate of the plant. Although some tilt-stations and also robotics were introduced Anders Sandberg uses the term 'despotic Taylorism' (see Adler and Cole) to characterize the plant. There

are several reasons why workers still stay: wages are relatively high and so is unemployment.

The Swedish Motor Assemblies Sendirian Berhad (SMA) in Malaysia, is a joint venture between AB Volvo and their local distributors and the first car assembly plant in Malaysia, established in 1966. Jobs are routinized with tight hierarchical supervision. The background to such establishments, explains Hing Ai Yun, was high import tariffs and other restrictions on car imports. Later a national car project with strong state ownership made conditions difficult for other car assemblers, so production diminished also for the SMA.

The future: lean production, automation and human-centred production

Looking just at Volvo plants we found different production models under different market conditions. In Japan today we find not only the very big plants but also smaller ones, like for example Takada Kogyo Co. presented below, producing short series of cars for very specific customer segments.

We will also find that lean production is not monolithic. Solving the problems of lean production when it comes to vulnerability of production and perhaps most of all the ‘crisis of labour’ and recruitment problems we find, not least within Toyota, tendencies towards humanization of work in the newer plants; in the background there is now criticism from Japanese auto unions. Also continued automation is at present not a self-evident solution; Toyota’s newest plant has a lower automation level than the preceding one.

Lean production with tough working conditions for a reduced number of workers is usually discussed only on the micro, company level. If applied in workplaces in general, there may be important macro consequences with a very heavy burden placed on the public sector, which already has fiscal problems.

Together the above factors seem to contribute to a growing importance for human-centred production, and we will discuss them more in detail in the following sections.

Takada Kogyo Co

Turning thus to Japanese experiences we will first consider a tendency of the Japanese product market, towards far-reaching customization of production. We take an extreme example, of the production of very small lots of so called ‘recreational cars’ with a fashionable design for narrowly defined customer segments. Although Uddevalla was not intended for this type of production

and indeed produced longer series of cars, the example, though it may seem marginal, may serve as an illustration of Uddevalla's potential.

Subcontractors have in cases like these, absorbed production technology and management know-how from their parent companies and embarked on design and assembly of finished products. They produce several car models at a time. An example, is the Takada Kogyo Co. plant in Yokohama, within the Nissan network¹⁷. There are 1000 full-time, permanent workers and around 300 short term employed. Takada Kogyo started as a pressing and stamping company which now design its own car models with fashionable bodies. They buy chassis, engines and transmissions from major car companies, especially their parent company. Development time is short, down to one year. As an example, Subaru Vivio Ttop, is planned for a total volume of only 3000 cars, with a production of 18 cars a day, on a final assembly line with a job cycle of about 25 minutes. Other car models, may have a volume of one to two thousand per month, like Nissan Figaro. For profitable assembly-line production at Takada, a volume for each model of at least 400 cars per month is generally needed. For small volumes of special cars like ambulances, bridal cars etc., a handicraft-like mode of production is used.

The Uddevalla mode of production could perhaps provide a productive application for the type of assembly taking place at Takada replacing what is now short line production as well as the handicraft-like production method. The Uddevalla model, through its flexibility and the competence of the workers, enhances market contacts both at the design and the sales stages, and has a potential of efficiently producing cars with a high degree of customization¹⁸.

Lean production and work in Japan

Most discussions about industrial organization in the beginning of the 1990s, refer to the Japanese experiences and the book *The Machine that Changed the World*, by Womack et al. (1991). Dan Jonsson makes a methodological critique of this book in his chapter. The book has aroused an immense interest and debate mostly about productivity aspects, with little emphasis on the consequences for the employees and for society¹⁹. Norbert Altmann in his chapter considers the latter issues. He points to some negative aspects of Japanese forms of production, such as: segmentation of the workforce; polyvalence (meaning broader skills but not higher); a division of labour in the Kaizen process (with special teams doing the qualified Kaizen work); personnel assessment systems with a high degree of subjectivity; a ratio of 2:1 in wages between core manufacturing workers in large companies and female marginal workers²⁰; virtually unrestricted duration and flexibility of working hours; and no role for unions in work design. Altmann comments

that these aspects imply that Japanese forms of work organization do not succeed in allowing labour to unfold to its fullest capacity, so there may be a potential for further productivity growth.

Recent developments and pressures towards change in Toyotism and more generally in lean management systems, are discussed in this volume by Shimizu, Grønning and Lillrank. They all, to different degrees, talk about humanization of the production systems within Toyota against the background of what Shimizu calls a 'crisis of work' around 1990. In its newest plants, Tahara IV and Kyushu, Toyota focusses on work environment to a greater extent than before. Toyota manager Tadaaki Jagawa said: 'Maybe we made a mistake in designing such gloomy factories' (*Financial Times*, Feb 2, 1992). Moving production to the southern island Kyushu is in itself an expression for recruitment problems in central Japan. The long distance transportation, overnight by ship, of most components from central Japan means a break with the 'just-in-time' principle (JIT). Furthermore, the congestion of roads has contributed to the need for storing components, contrary to the JIT philosophy. More fundamental is perhaps the breaking up of assembly lines into mini-lines with more autonomy for workers and teams.

In Toyota Kyushu there is a new shift system adapted to female workers, who at the time of my visit in May of 1993 constituted 70 out of 900 manual workers. As to the working environment, air conditioning is advanced and noise level relatively low. The cars move on platforms, the height of which is adjustable, which allows for a more comfortable working posture. There are 11 assembly lines with a buffer of a few cars between each. Each line with about 40 workers per shift has 3 foremen. For the 11 lines there are 8 production managers and 2 section managers. The shorter lines are meant to enhance visibility of the product as well as worker autonomy and responsibility. They are also meant to reduce stress. The stress referred to is not the one related to intense repetitive work, but rather, to the fact that small disturbances may stop the whole factory. With buffers the workers may in a more relaxed way stop a part of a line. The job cycle was reported to be 66 seconds.

In Nissans Kyushu plant, platforms carrying the cars have been introduced. They are coupled to each other like a train. But if a platform was stopped the platforms in front could continue and only those coming after were stopped. Depending on volume, the job cycle time was 1–2 minutes. When asked about work organization, a Nissan union representative had no issues to bring up, but mentioned the importance of air conditioning and worker welfare.

Moving to Kyushu and being 'nice to people', as the Toyota slogan goes, may be a contribution to the remedy of recruitment problems in the 1990s. Important changes are taking place in ergonomics and physical work en-

vironment, but there is no questioning of the line technology and of work organization with short job cycles and detailed supervision. The proportion of supervisors and managers is high when compared with Uddevalla and Saturn (Hancké and Rubinstein). Another recent development, is the emphasis on white collar rationalization directing lean principles towards office bureaucracies. In a more long term perspective automation of simple manual work has been seen as a solution (Lillrank).

In the new Kyushu plants brighter factories and cafeterias, shorter lines with buffers between them, carriers and better ergonomics, are found, with production design ideas somewhat reminiscent of Volvo's Kalmar plant from the 1970s. However, there seems to be little interest in more radical concepts of work and technology like those found at Uddevalla.

There is a new attitude towards automation in the Toyota Kyushu plant where one starts at a relatively low automation level. The automation level is lower than in Tahara IV, where even the marriage between chassi and engine is fully automated. It is also lower than in Nissan's Kyushu plant. The reason given for the lower level, is the cost of automation. Perhaps, then in the medium term, automation may not be the solution to possible labour market resistance to car industry work.

Japanese Auto Workers' criticism

Challenges to lean production come not only from the labour market but also from the product market. Customers may not be willing to pay for the wide variety and for short model cycles. There are tendencies, especially in Nissan, for model cycles to become longer and the number of variants fewer.

This and other critical aspects of Japanese car production can be found in the programme 'Japanese automobile industry in the future', prepared by the Confederation of Japan Automobile Workers' Unions (JAW, 1992). One main thesis is that Japanese auto industry has been able to maintain high levels of production and sales, but at the price of 'triple sufferings': exhausting the employees resulting in labour shortage, low profitability and being bashed from abroad.

In a similar way representatives of the Japan Council of Metal Workers' Unions (IMF-JC), discussed the well known '3 M's': *Muda* (non-value-added, waste), *Muri* (overburden) and *Mura* (unevenness in capacity utilization). They said *Muda* and *Mura* are well known and discussed in the West, but one sometimes forgets *Muri*, which means pushing a person or a machine too far. Preventing *Muri*, could be a union task (interview in May, 1993).

Due to labour shortage and low profits, there is according to JAW, a tendency among part manufacturers to decline orders. This may threaten the 'just-in-time' method, although the present recession may ease the labour

market somewhat. After 1995, a decline in the supply of young workers is predicted. The long working hours are criticized abroad as an expression of unfair competition.

The JAW also criticize a central aspect of Japanese management:

Under the pretext of sharing a common destiny, which is pleasing to the ear, companies do seem to have been too demanding of their workers. Companies and their employees have turned inwards into the confines of the company. This has created a gap between company and society. ... The sense of 'family' is supported by devotion of each member, which sometimes requires self-sacrifice. ... What is needed now is ... making the self-realization of employees through their work go hand-in-hand with healthy corporate development. (JAW, 1992:21–22).

Although not explicitly stated this seems to be a criticism of the Japanese team concept. As Peter Wickens (1993), of Nissan UK writes, such team work is not about certain organizational structures or leaving sequential manufacturing. Rather according to Wickens:

A team begins with a group of individuals whose individual contributions are recognized and valued and who are motivated to work in the same direction to achieve clear, understood and stretching goals for which they are accountable. The best teams come with positive leadership and tough goals.

I have referred extensively to the JAW programme because issues of this type, particularly Japanese union perspectives, are completely absent from the work of Womack et al.

Work, technology and management

Returning to production technology, organization of work and management, the role of job content remains a key aspect. In the sociotechnical, or human-centred tradition, long work cycles and work group autonomy is seen as an important value of its own, contributing to good jobs for human beings. It is also seen as a new productive concept, both as a way of motivating workers and as a way of avoiding the engineering losses that follow with short cycle line production. In Scandinavia, with Uddevalla as an important example, and in Germany, this work organization is coupled to a relatively strong union influence on job design.

The Japanese lean model combines short cycle jobs, standardized detailed work procedures applied to the whole organization, and worker involvement in rethinking and improving these same procedures. Lillrank in this volume discusses this informal mixing of rule following and participation in im-

provement efforts. Wickens (1993, p. 87) argues that: 'job satisfaction can arise from performing the short, repetitive cycle well, achieving high levels of productivity and quality, and at the same time being involved in changes to the process and a range of other tasks'. According to Cole and Adler, such a system is part of the essence of Nummi's version of lean production. They say that it contributes not only to world class performance, but also to a moderately high level of worker motivation. They call this system a 'learning bureaucracy'. That may be a good description, but from a European human-centred perspective, I think that their term 'Democratic Taylorism' could be seen as problematic. Even in the case of Uddevalla, with its richer work content and worker influence, both in day-to-day management and via union influence in the design process, there is seldom talk of democracy.

On the other hand, one should not deny the satisfaction of working in a 'learning bureaucracy', which through a long process of improvement, is functioning very smoothly and delivering high quality products. One can imagine, however, that such a system will remain stable only if the general organizational principles are taken as given. Possibly more critical learning in wider circles may contribute to workers questioning basic principles of industrial organization – such as additive learning and sequential flow – as a logical consequence of trying to find the primary causes of the dysfunctions of sequential line production (as emphasized by Freyssenet). In spite of Kaizen, detailed division of labour and direct control might, in such a perspective, stand out as neither democratic nor learning. The continuity from traditional 'despotic' Taylorism is strong and changes due to Kaizen are sometimes exaggerated. This may partially be explained by the fact that production workers are often involved only in low level Kaizen activities, whereas more qualified Kaizen activities are taken care of by special Kaizen teams or by more qualified workers, maintenance workers or supervisors. There is a division of labour in the Kaizen activities.

As early as in the 1950s Robert Blauner summarizing American research on auto work, emphasized the role of technology in determining the character of work. Later, in the sociotechnical tradition Emery and Thorsrud stressed job design. Womack, Jones and Rose (1991) emphasize the role of management in determining work. They argue that with lean production, the same technology results in different work. This is similar to Cole and Adler's thoughts on worker participation in improvements of standard procedures, which would contribute to making Nummi's Taylorism seem 'democratic'.

Expressing what could be seen as either pure contempt or ignorance of the socio-technical tradition, Womack et al. (1991, p. 102) comment upon Uddevalla in the following way: 'simply bolting and screwing together a large number of parts in a long cycle rather than a small number in a short

cycle is a very limited form of job enrichment'. Based on a 5 plant survey of how workers perceived working conditions, Berggren (1993a), is able to refute this point of view. He demonstrates a close connection between technical-organizational design and working conditions. The results are clearcut: 'The further from traditional line assembly a plant moves, the better the outcomes in terms of variation, prospects for personal growth, the taking of responsibility, and the opportunity to use ones skills', and the lower the level of physical strain and severe fatigue after work. In all fragmented assembly, production workers expressed a strong desire for more variety and integrated tasks. Holistic, long-cycle assembly, thus, turns out to be something else than simply 'screwing together a large number of parts'.

Uddevalla's 'enriching production' is fundamentally different from Taylorism and Toyotism, from human, technical and market points of view. In assembly, lean production like Taylorism means repetitive, standardized short cycle jobs. To this comes 'team work' with some rotation and supplementary tasks like inspection and minor repair work as well as contributing to refinement of the standardized procedures.²¹ Human-centered work of Uddevalla's type is very different in that it abolishes the line and presents a total parallelization of production which allows for advanced customer orientation, interaction between workers and designers, as well as worker autonomy and long work cycles in assembly. It tries with reasonable success to integrate work, technology and management in a learning, non-alienating process.

Lean production and society

So far we have focussed on the consequences of lean production for work and workers. A broad and widely spread application of lean production would also have major consequences on the societal level. There is an important micro-macro dimension in lean production. Analyzing this dimension, Peter Auer in his contribution argues that, although lean production may be a remedy for individual companies, it may create deterioration of the economic and social climate in general. In a lean cost-cutting world, social responsibility for companies will be impossible, and the whole social burden will be placed on the public sector. Massive job shedding may take place and remaining jobs may not be enough to finance an advanced welfare state. In summary, Auer argues that if lean production is widely introduced the macro-economic consequences may threaten even the fundamentals of the economy itself. In an isolated supply side micro-economic view, high wages are cost factors that will affect competitiveness and destroy jobs. In a demand side macro-view, high wages spur demand and creates jobs. It might be necessary to achieve a combined supply/demand and micro/macro policy with an optimum level of leanness.

'Competition and free trade does not simply expose technical inefficiencies which could and should be rectified by virtuous management efforts to improve productivity'. It is also 'a misfortune which undermines the more generous social settlements' writes Williams et al., in their chapter, and they hold the opinion that a prime task for the European Community 'should be to put a floor under destructive competition between social settlements'. In a highly competitive world, a high standard of social protection and humane work may not be possible in one country. This type of policy needs international cooperation setting minimum standards of social and environmental protection. A developed socio-economic logic may become an advantage for Europe, whereas for Japan, some of the social aspects and new demands are perhaps its achilles heel (Auer).

Some of these conclusions are supported by the the JAW report, mentioned above. The report finds that Japanese auto manufacturers engage in 'excessive competition', because of too frequent model changes, and too much diversification in models and parts. Such costs could be reduced to the advantage of investments in new technology, such as environmental protection, and also an 'appropriate valuation of the workforce' (JAW, 1992, p. 23). 'To expand overseas markets based on a domestic structure of excessive competition is the same thing as to export excessive competition. Before we criticize political intervention in economic activities, we should realize that the market is not almighty' (p. 19). In a postscript the advisor of JAW, professor Shimada, writes: 'Competition for the sake of competition has dominated, and everything was sacrificed, including wages, working hours, profits, subcontractors, dealers, the lives of Japanese workers, and employment opportunities of workers abroad' (p. 33).

Lean production has its limits. Profits of Japanese car producers are low. Customers may not be willing to pay the cost for the many variants and quick model changes. Young people are beginning to reject work in car plants due to long and tough working hours. There are risks of job shedding that may create social tensions and destroy the basis for social welfare and cohesion. On the micro level, it is necessary and possible to go beyond the onesided focus on the leanest possible production of a Japanese type. At the same time it is necessary to develop the Scandinavian-German 'human-centred model' of work so that productive performance comes more into focus. The fierce international competition will regulate or monitor that the productivity aspect is not neglected. To secure human work and decent social standards, international political and trade union cooperation may give a basis for a supplementary macro demand side policy. Also a policy is needed that will supplement the product market driven development of still leaner production with a social-policy and labour market driven further development of human-centred production, including its productivity potential. An interest-

ing sign is that in May of 1993, representatives from the Japan Council of Metal Workers' Unions, IMF-JC, and the German IG Metall Union met in Tokyo, to a first comparative seminar discussing living and working conditions, wages and production systems.

With such international cooperation growing, we may see new production concepts going beyond lean production and making use of experiences of the Volvo Uddevalla system of reflective production. 'Enriching production' may become a real possibility.

Notes

1. References here and below with no year after the name of the author refer to chapters in this volume.
2. Articles by researchers, unions and management on Volvo and the closure of Uddevalla were published in several main newspapers during the spring of 1993. An important article posing questions to management, shareholders, politicians and unions was written in the leading Stockholm daily *Dagens Nyheter*, April 6, 1993, by Elsie Charron, Kajsa Ellegård, Michel Freyssenet, Bob Hancké, Ulrich Jürgens, Rianne Mahon, Lennart Nilsson, Åke Sandberg, Jesper Steen, Peter Ullmark and Karel Williams. During the spring of 1994 debate continued in connection with the closure of the Kalmar plant.
3. This was emphasized by Hammarström, 1993, of the SIF (Swedish Union of Clerical and Technical Employees in Industry) in the debate on the closing of Uddevalla and Kalmar. The engine plants in Vara and Skövde are important examples, as well as the truck plant in Tuve near Gothenburg.
4. For a detailed analysis see the contribution in this book by Berggren and also Ellegård, and Engström and Medbo. See also Berggren's (1993b) evaluation report and articles by Sandberg 1993 a, b and c.
5. The Uddevalla plant, like Kalmar, was an assembly plant. Painted bodies were brought there from Gothenburg.
6. This is just an example of the weaknesses of the calculation, discussed more in detail in Berggren's contribution.
7. The following sections is a development of arguments in earlier articles, Sandberg 1993 a, b and c which were based on an original article in *Dagens Nyheter* Feb 4, 1993; see also Berggren, Ellegård and Hancké and Rubinstein in this book.
8. Developing such a new integrated system of work organization and wages does not only apply to Uddevalla, but is an important strategic problem for unions trying to find an answer to modern post- or neo-Taylorist rationalization strategies. There is a need for a 'new historical compromise' on rationalization and wages replacing or supplementing Taylorism and piece rate systems. LO, the Swedish Confederation of Trade Unions, is among those trying to find and answer to this challenge. See also Metall, 1992, and note 11 below.

9. See a recent book on total quality management by Pierre Jocoü (1992), the influential director of quality at Renault.
10. These opinions may be compared to experiences from the German auto industry where the concepts of most auto producers express expectations that group work will contribute to higher flexibility and performance of the workforce. But, judging from the collective agreements, introduction of group work will not be accompanied by substantial competence development (Range 1993). Similar aspects are discussed regarding so called VEC-teams in Volvo-Gent (see Huys and Hootegem).
11. The Metal workers' union in a recent publication (Metall, 1992:39), makes some important conceptual distinctions. *Career* means that some individuals (but not all), may move to another job given an unchanged work organization. *Multiskilling* means that a person learns to perform tasks within another job, which may be open to all, but the work organization remains unchanged. *Job development*, the preferred solution, means that all individuals have the possibility to gradually learn and perform new tasks within a broadly defined job. The detailed division of labour in the old work organization is changed (See also Sandberg 1994).
12. This conclusion on the company management level may also be compared to the difficulties concerning organizational innovations survival within one plant partially organized according to traditional principles (see the discussion on the Volvo trajectory above).
13. The discussion of dominating ideas and releasing factors owes much to Albert Danielsson (see *Samtal om ledarskap, ledning och ledare*, 1986).
14. See article by Volvo Car CEO Lennart Jeansson in *Dagens Nyheter*, April 13, 1993. Jeansson wrote: 'It is worth pointing out once more - the decision to close the plants in Kalmar and Uddevalla is a necessary decision in terms of capacity and adaptation to prevailing conditions and not, as many seem to believe, an evaluation of different production methods' (author's translation).
15. See P.O. Bergström (1993), of the Swedish Metal Workers' Union.
16. Comparing job redesign at Volvo in Sweden and British Leyland, Pontusson, 1990, finds the explanation mainly in differing labour market conditions.
17. Professor Masayoshi Ikeda, Chuo University, generously shared with me his knowledge and experiences of this type of small lot production. He arranged a study visit at Takada Kokyo Co. in Yokohama, where managing director Shoshin Migita and his staff gave us valuable information. See also a paper by Ikeda (without date).
18. As we will see below, some of the tendencies in Japan of fashion oriented design and quick model changes have been criticized for environmental and safety reasons by Japanese unions.
19. See however e.g. Williams and Haslam, 1992, Berggren et al., 1991 on Japanese transplants in the US, and an overview article by Unterweger, 1992.

20. Between the years 1981 and 1989, the yearly cash earnings of employees in small manufacturing enterprises (4–9 employees), was between 43 and 45 percent of those earnings in enterprises with more than 1,000 employees. In 1990, female employee earnings was about 60 percent of those of the male counterparts. (Matsuba, 1993).
21. Stephen Wood (1993) summarizes much of the discussion of fordism and the Japanese management model, and concludes that the latter may be regarded as neo-Fordist rather than post-Fordist: Workers participate in continuous improvement, but from Fordism management's right to design work remains intact, as well as work study, assembly lines, mass production and mass marketing.

Interviews and plant visits during the spring of 1993

- Volvo, Uddevalla and Kalmar: managers, car assemblers and trade unionists
- Renault headquarters: managers and trade unionists; plant visits
- Japan: plant visits to Toyota Tahara and Toyota Kyushu, Nissan Kyushu and Takada Kogyo in Yokohama, including meetings with plant managers and at Nissan, a union representative.

Interviews with representatives for Japan Council of Metal Workers' Unions (IMF-JC) and the Federation Of All Toyota Workers' Unions within the Confederation of Japan Automobile Workers' Unions (JAW), Tokyo.

The visits to the above and other plants in Japan were organized by Mats Brusæus and Keisuke Kurihara at the Swedish Embassy and by Ryu Suzuki of the Social Research Institute of Japan. Ryu Suzuki and Kyoko Kodera from Chuo University acted as translators during visits and interviews.

Acknowledgements

I want to thank those who so generously helped me in many ways with plant visits and interviews. Special thanks to the former employees at Uddevalla. I want to thank the following colleagues for comments on earlier drafts of this chapter: Jesper Steen and Peter Ullmark, the Royal Institute of Technology, Stockholm, Christian Berggren, Niklas Bruun, Wuokko Knocke, Klas Levinson and Casten von Otter, The Swedish Institute for Work Life Research. Cecilia Runnström (editor, with whom I worked on this book project) gave valuable comments and so did Fern Scott. This chapter builds on an earlier working paper on which I got comments from some of the colleagues above and from John Andersson and Albert Danielsson, Royal Institute of Technology, Stockholm, Kajsa Ellegård and Lennart Nilsson, Gothenburg University, Bengt Sandkull, Linköping University and Arne H. Eriksson, Gunnar Gelin and Birger Viklund, The Swedish Institute for Work Life Re-

search and the following visitors to the Institute: Rianne Mahon, Carleton University, and Taro Miyamoto and Takeshi Shinoda, Ritsumeikan University. The paper was also discussed in seminars at Chuo University, Tokyo and at Ritsumeikan University, Kyoto where I received valuable comments from among others Akihiro Ishikawa, Tokyo and Katsuji Tsuji, Kyoto.

References

The chapters in this book are referred to in the text above with the authors name only (without year of publishing). They are not listed below.

- L'accord à vivre de Renault, (1989), *Renault Automobiles*, Boulogne Billancourt, 29 Dec., 1989.
- Berggren, Christian (1993a), *The Volvo Experience. Alternatives to Lean Production in the Swedish Auto Industry*, MacMillan, London.
- (1993b), *Mästar prestationer eller mardrömsfabriker?*, Institutionen för arbetsvetenskap, KTH, Stockholm.
- Berggren, Christian, Torsten Björkman and Ernst Hollander (1991), *Are they unbeatable?*, Royal Institute of Technology, Stockholm.
- Bergström, P.-O. (1993), 'En industriell tragedi', *Arbetet*, April 22.
- Charron, Elsie et al. (1993), 'Stannar Volvo i Sverige?', DN Debatt, *Dagens Nyheter*, April 6.
- Cressey, Peter (1993), 'Kalmar and Uddevalla: The demise of Volvo as a European icon', *New Technology, Work and Employment*, Vol. 8, No 2, September.
- Danielsson, Albert (ed.) (1986), *Samtal om ledarskap, ledning och ledare*, Svenska Dagbladets förlag, Stockholm.
- Ellegård, Kajsa, Tomas Engström and Lennart Nilsson (1992), *Reforming Industrial Work – Principles and Realities*, The Swedish Work Environment Fund, Stockholm
- Forslin, Jan (1992), 'Towards integration: the case of Volvo engine division', *P+ European Participation Monitor*, Issue No 3, European Foundation, Dublin.
- Gyllenhammar, Pehr G. (1993), 'Bräckliga påståenden', DN Debatt, *Dagens Nyheter*, April 1.
- Hammarén, Maria (1989), article in the journal *Ny teknik*, spring
- Hammarström, Olle (1993), 'Rädda idéerna i Uddevalla', *Göteborgs-posten*, May 16.
- Ikeda, Masayoshi (no date), *Production and Development Network Between Large Corporations and Subcontractors*, Chuo University, Tokyo (mimeo.)
- JAW (1992), *Japanese Automobile Industry in the Future: Toward co-existence with the world, consumers and employees*, Confederation of Japan Automobile Workers' Unions, Tokyo.

- Jeansson, Lennart (1993), 'Dystra siffror viktig bakgrund', DN Debatt, *Dagens Nyheter*, April 13.
- Jocou, Pierre and Frédéric Lucas (1992), *Au cœur du changement*, Paris, Dunod.
- Matsuba, Masafumi (1993), 'Contemporary Japanese Economy', *Ritsumeikan Social Sciences Review*, Vol. 29, No. 2, September
- Metall (1992), *Löneteknisk handbok*, Stockholm.
- Metallarbetaren* (1993), 'En besviken metallarbetare', January
- Nilsson, Lennart (1985), *Naturligt arbete och industriellt lärande*, Inst. för pedagogik, Göteborgs universitet, Göteborg (mimeo.).
- Pontusson, Jonas (1990), 'The politics of new technology and job redesign. A comparison of Volvo and British Leyland', *Economic and Industrial Democracy*, Vol. 11, No. 3.
- Porter, Michael (1990), *The competitive advantage of nations*, Macmillan, London.
- Qualité en mouvement* (1992), No 9, Novembre.
- Ränge, Ulrich (1993), 'Aktuelle Gruppenarbeitskonzepte in der deutschen Automobilindustrie', *Die Mitbestimmung*, No 9.
- Rickhamre, K. G. (1993), 'Kulturkrock', *Personal*, November.
- Sandberg, Thomas (1982), *Work organization and autonomous groups*, LiberFörlag, Stockholm.
- Sandberg, Åke (1994), 'Justice at work', Akihiro Ishikawa et al (eds), *Market Economy and Social Justice*, Chuo University Press, Tokyo.
- (1993a), 'Volvo human-centred work organization – the end of the road?', *New Technology, Work and Employment*, Vol. 8, No. 2, September.
- (1993b), 'Volvo am Scheideweg – Effektive und menschliche Fabriken werden ohne triftige Gründe geschlossen', *Arbeit*, Vol. 2. No. 2 and in a somewhat different version in *Frankfurter Rundschau*, April 29, 1993.
- (1993c), 'The end of the road? – Does the closing-down of Volvo's Uddevalla plant mean the end of a European alternative to 'Toyotism'?', *Ritsumeikan Social Sciences Review*, Vol 29, No. 2 (in Japanese).
- Sandberg, Åke, Gunnar Broms, Arne Grip, Lars Sundström, Jesper Steen, Peter Ullmark (1992), *Technological Change and Co-determination in Sweden*, Temple University Press, Philadelphia.
- Streek, Wolfgang (1987), 'Industrial Relations and Industrial Change', *Economic and Industrial Democracy*, Vol. 6. No 2.
- SRI International (1992), *Volvo Cars. Audit industriel et commercial*, Paris (mimeo.).
- Turner, L and Peter Auer (1994), 'A diversity of New Work Organization. Human-centered, lean and in-between', *Industrielle Beziehungen*, Vol. 1, No.1.
- Unterweger, Peter (1992), *Lean Production: Myth and Reality*, International Metalworkers' Federation, Geneva
- Wickens, Peter (1993), 'Lean production and beyond: The system, its critics and the future', *Human Resource Management Journal*, Vol. 3, No. 4.
- Williams, Karel and Colin Haslam (1993), 'Volvo utan framtid', DN Debatt, *Dagens Nyheter*, March 27.
- (1992), 'Against lean production', *Economy and Society*, Vol. 21, No. 2.

Womack, James P, Daniel T Jones and Daniel Roos (1991), *The Machine that Changed the World*, Harper Perennial, New York.

Wood, Stephen, (1993), 'The Japanization of Fordism', *Economic and Industrial Democracy*, Vol. 14, No. 4, November.

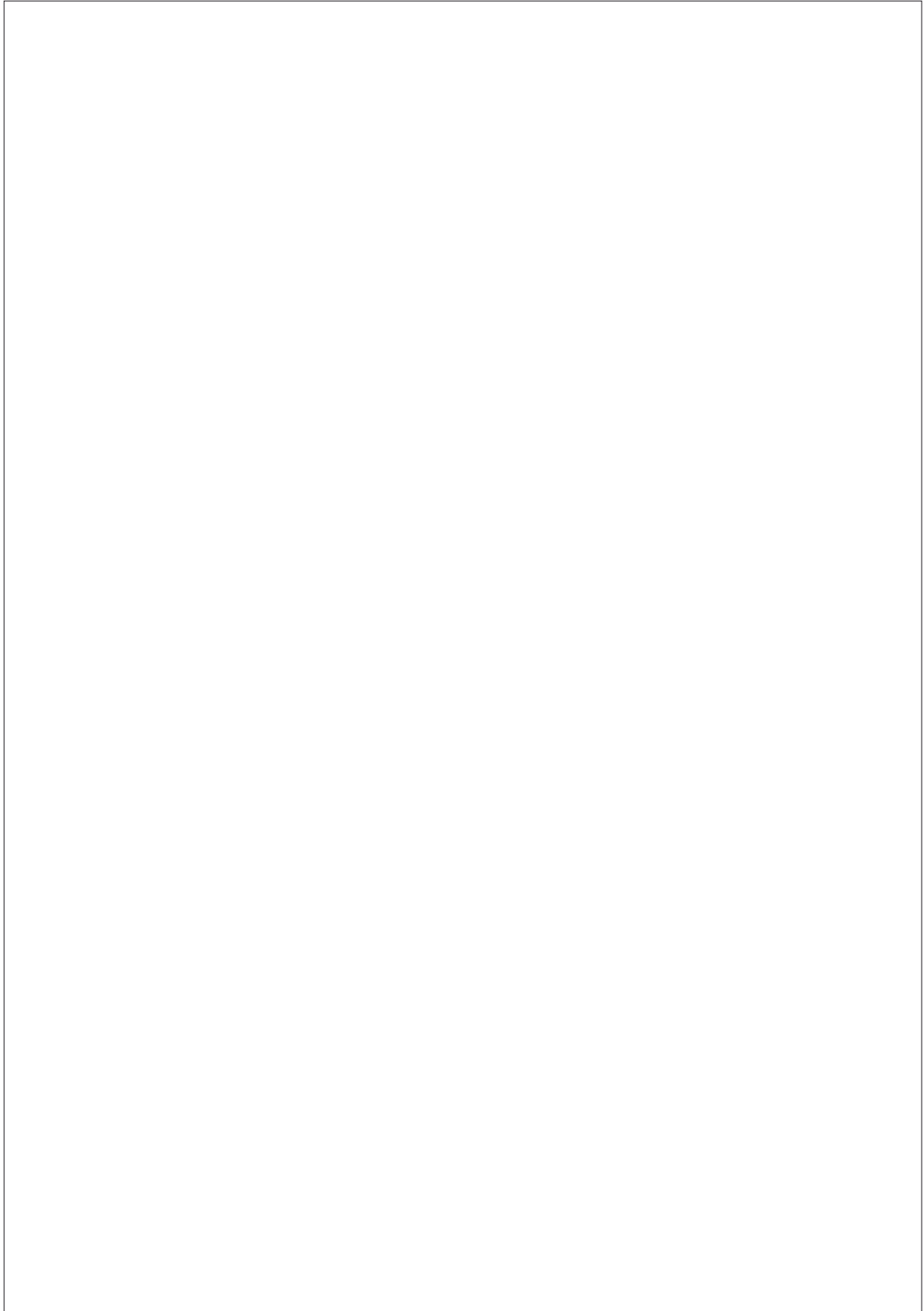

Part I

**Volvo's innovative
Uddevalla and Kalmar plants**

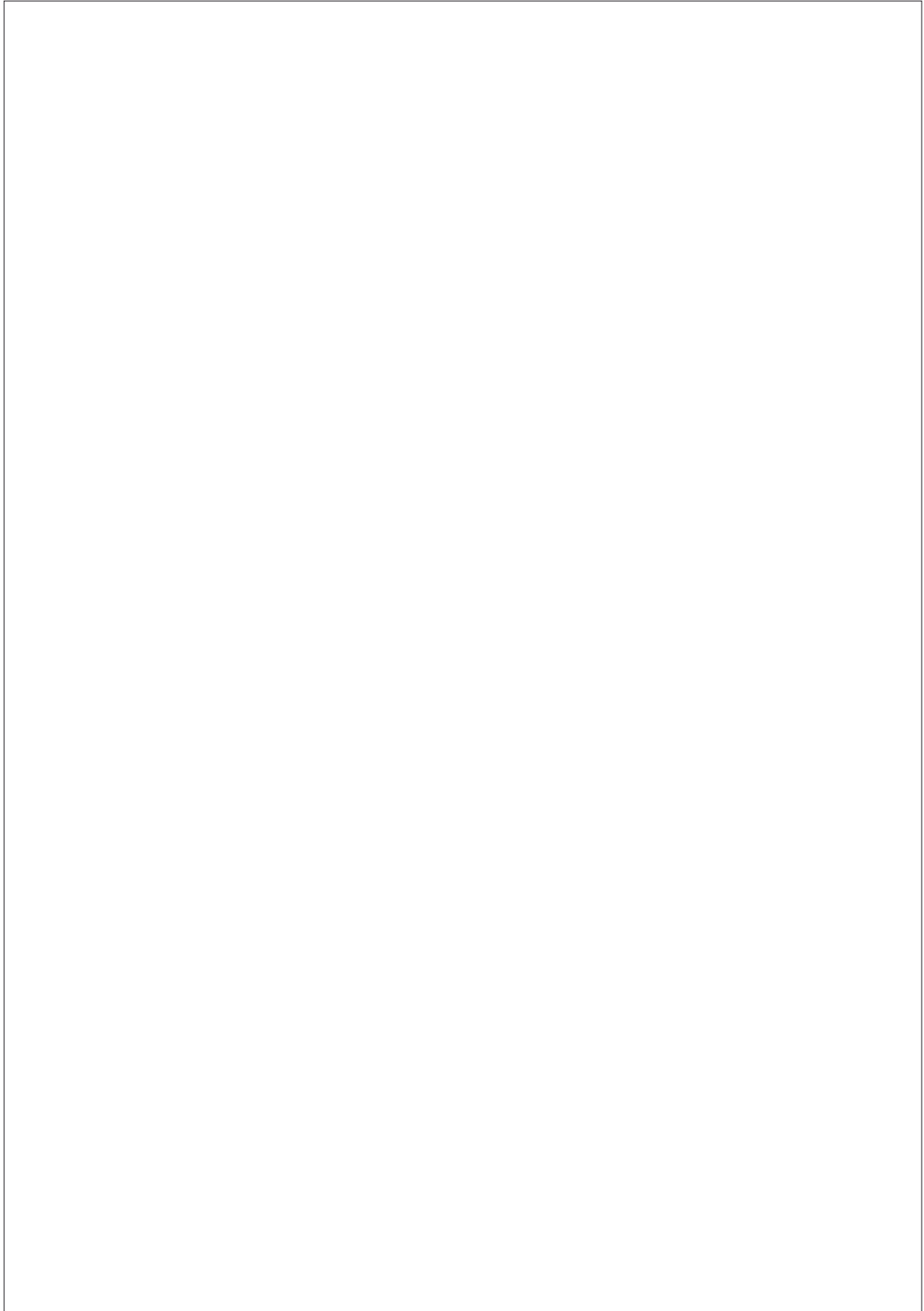

The creation of a new production system at the Volvo automobile assembly plant in Uddevalla, Sweden

Kajsa Ellegård

Some comments will be made on the creation of the new production system, which we, as researchers, have named the 'Reflective Production System' (1). It was created when Volvo, in the late 1980s, planned a new automobile factory in Uddevalla (2).

Some fundamental questions for the understanding of this creative process will be put forth. The point of departure is that the 'Reflective Production System' relies on a set of assumptions that differs in nature from those assumptions which support the production system in plants with an assembly line. Also, some characteristics of the product flow pattern of the 'reflective production system' in the Uddevalla factory will be briefly described, as well as the work organization and the necessary prerequisites for it. These are extended competence in car building, parallelized assembly work stations and a steadily ongoing process of change and improvement.

1. What is new?

This question can be answered by taking the role of a first time visitor to the Uddevalla factory: The first impression concerns the visible part of the work environment, which is very light and spacious.

This does not differ so much from any other modern factory, though other things appear that do differ from what can be seen in other car plants:

- it is quiet,
- the cars being assembled stand still, side by side, during the assembly,
- people are working together in small groups and they communicate frequently,
- nothing seems to go on in a hurry,
- the car stands at the same place for a long period of time, equalling several hours,

- and the factory is small compared to most other car plants.

The next impression concerns the technical equipment:

- that is the absence of an assembly line. The flow of cars is instead extremely parallelized in the product shops,
- sets of materials are individually packed for each body (small details and larger components are placed in a strict order on shelves and stands). The car body and its sets of materials are sent to the assembly area by automatic guided vehicles,
- automatic guided vehicles are also used to transport the complete cars from the product shop,
- the car remains at the same place during its entire assembly,
- people are moving around the body, performing their different tasks in the assembly work while the car stands still,
- the same persons do all their work in a small assembly area,
- many hand machines are in use, but there are a few big, complex machines.

Another impression is that it is very hard to discover the production pace. It is not immediately visible due to the absence of an assembly line and due to the long work cycles. When there are no short work cycles, the degree of repetitiveness is very low. The same task is thus performed by the same worker only a few times a day.

A first time visitor is not immediately aware of the fundamental structure of organization of the assembly process. However, once discussed with the people working there, much can be learned. It is difficult, however, to interpret the impressions from such discussions when using a set of mental tools applicable for analysis of a traditional line factory.

Thus, a first conclusion now can be drawn. The real innovation is the way in which human learning and human knowledge is used as a starting point for developing new principles of production techniques. One of the most important technical principles concerns the handling of materials when the body stands still during the assembly (3). The materials handling is arranged so as to facilitate the assembly work, by taking into account the ways in which people think and perform in a natural way.

Human knowledge, i.e. personal knowledge and ability of the individual worker, is a fundamental underlying prerequisite for the production technique developed in the Uddevalla factory. The total body of knowledge of assembly work is distributed among the people and utilized in a quite different manner from other car factories. More knowledge is demanded from each individual in the teams. The workers themselves exercise control over the totality of assembly work, including work pace. They have an inner view of the process, and when they have the complete set of materials

for assembling one car they can perform their work very efficiently. This makes the 'Reflective Production System' very flexible and resistant to such disturbances that in traditional production sites would cause severe problems (4).

The main reason for the need of extended individual competence was the demand for efficiency and profitability. Extended competence allows for an overview for the individuals, which is necessary for their understanding of the assembly process. Once an understanding is achieved it becomes possible for the individuals to trace new and better ways to perform. This leads to increased efficiency, higher productivity and profitability. Thus, the combination of competence and a technical system built to meet human abilities, generates goal achievement.

2. Why did this new production system develop?

In the mid 80s Volvo needed to expand its production capacity. The demand for Volvo cars increased steadily during the first part of the 80s, whereby existing plants could not meet this demand without great changes. At the same time, work in industry was not correlated with positive values among people in the work force in Sweden, and the car plants were mere symbols for monotonous work on seemingly endless assembly lines. Concurrently, the labour market in Sweden was very hot during the mid 80s, with an unemployment rate of only about 2 percent. Hence, it was hard to find people willing to work in traditional industries in general and automobile industries in particular. The metal workers union in Sweden had for several years argued and worked for the creation of 'good work' for its members. The national metal union in Stockholm, as well as the local Volvo metal union in Gothenburg, found the plans for a Volvo plant in Uddevalla to be an opportunity to put into practice the 'good work' philosophy. Others, however, in Gothenburg saw the plans as a threat to the jobs for the metal union's members in the old plant in Torslanda, Gothenburg.

Volvo wanted to be able to recruit good workers to its automobile plants in order to produce quality cars in an efficient and flexible production system. Since the experiences from the Kalmar plant (an innovative plant of its time) were good, not only concerning production results but also because it led to positive publicity all over the world, the company wanted to make a new effort to create something extra.

Volvo raised the goals for the Uddevalla plant which aimed at the creation of a profitable and flexible factory, with high total productivity, the best quality and where at the same time the people felt that they had a good job. Also, the cooperation between the company and the unions were meant to develop further during the planning of the factory in Uddevalla. Therefore, it was

important that all union representatives were favourable towards the creation of a good working environment in the factory. This meant something very different from short cycle work tasks on an assembly line. The unions were represented in the planning group from the very beginning of the project.

One person in the management staff of the Volvo company, was fascinated by the concept of 'holistic learning' and 'natural work' presented at a seminar by a researcher from the University of Gothenburg. As a result of this interest the researcher was engaged in the planning of the Uddevalla factory from the start.

Volvo had for many years made experiments with new production layouts and flows, both in truck and car production on a small scale. Some of these experiments had shown very good results, even better than expected. There was, however, no obvious answer to the question: Why is it so good? The leading production technician from these experiments, a 'free thinker' in the company, was also involved in the planning process of the Uddevalla factory from the very start. He also utilized his contacts with researchers in the field of alternatives to line production at the Chalmers Technical University in Gothenburg. They knew, theoretically, that it should be more efficient and profitable to replace the assembly line with a highly parallelized product flow. This would, as a consequence, improve the working environment. The theoretical statements were yet to be proven. Their involvement in the design process became deeper and deeper through the years.

Involved in the planning process were also a few production technicians of a more traditional school whom exerted great influence in the beginning of the planning period. This meant that there was an intellectual struggle between these two groups of technicians. Some steps in this struggle will be indicated below by showing the changing plans from the planning group.

There were several circumstances present that worked in favour of the development of the new 'Reflective Production System'. Most important was the unique opportunity to combine the different spheres of knowledge and experience from the Volvo car company on the one hand, and from researchers, on the other. This was a necessary precondition and without it, the result would probably not have been successful, in spite of the other favourable circumstances. Some of the more important of those other factors were:

- Various parties within Volvo were in agreement as to the direction of the project and were thus in fact able to strengthen each others arguments in the daily work.
- The leader of the planning group handled new ideas in a way that favoured the new ideas favouring good working environment. New suggestions were not laid aside solely for lack of time, but were accepted even though they involved extra efforts in securing the approval

of the parties involved. For example, the first suggested layout for the assembly shop was laid aside because it lacked renewal. It was more or less a copy of the ten year older Kalmar factory. The majority of the planning group, the company executives and the union representatives, all envisioned something better than that.

- The close cooperation between the representatives from the four different unions and the creation of a new role for themselves were of decisive importance (5). They were able to leave the role of ‘demanders’ making claims and instead take the position of ‘suggestion-makers’.
- The entire planning group was seated in the same office, and all members, including the union representatives, worked full-time with the planning process. This geographical proximity made it easier to develop and try new design proposals, as discussions constantly could be started and all members of the planning group were easily involved.
- The negotiations concerning pollutants were protracted. This was important since the delay led to cancellation of the body and paint shops. Thus, an assembly shop only was eventually built. This cancellation at least had one short term positive and one long-term negative effect. The positive effect was that the planning group could concentrate on making something new in the assembly shop. Until the decision to proceed with the planning of an assembly shop only was made, the resistance to change concerning new ideas had been greatest in the subgroup planning the assembly shop. Now all forces were concentrated on that spot. The negative effect, the decision in autumn of 1992 to close the Uddevalla factory, was due in part to the lack of the body and paint shops.

3. How did the new ‘Reflective Production System’ evolve?

3.1 The trajectory for goal attainment – a descriptive model

The evolution of the ‘Reflective Production System’ followed a nonlinear trajectory over time. The initial goal of the planning group was to create a profitable factory. Whereby, the concrete goals were: high flexibility, high productivity and best quality, together with employee satisfaction. The goals remained the same during the entire planning process, as their attainment steadily improved. The planning process went more and more in the direction of a ‘competence intensive’ factory.

When the ‘Reflective Production System’ in the Uddevalla factory was developed, there was an interdependence between industry and research. Step by step the theoretical statements were tested in the factory. The stepwise development occurred, due to the strong resistance from many ‘traditionalists’, both on different levels in the company and within the unions.

Thus, during the developmental process the theoretical and practical levels were closely linked to each other as theoretical statements were practically tested and worked out. For example, an educational workshop was started in the spring of 1986, even before the final decision to build the factory. In the educational workshop, the first 20 car builders were on Volvo's payroll. Together the researchers and some skilled workers from other Volvo factories, transformed the theoretical principles for technology and learning into the small educational workshop, where it was applied. This test showed that the principles were correct, even when confronted with real world conditions. It also showed that it was possible to learn how to build a car with long work cycles, when the materials were exposed in such a way that the assembly was facilitated. In fact, the car builders quickly learned how to build at least one quarter of a car. After some months many of them were able to build half a car, some of them could build three quarters of a car and eventually there were some who could build the whole car alone. Therefore, this intensive competence growth proved to be achievable, when the new principles for learning and for grouping and exposing the materials were practised.

Using a descriptive model to give an overview of the creative planning process, the planning of the Uddevalla assembly plant can be seen as a trajectory. The trajectory, shown in figure 1, moves from the first idea presented, where each one of about 700 persons performed individual work tasks of about two minutes long in duration. The final idea shows a factory where small, independent parallel teams, with about seven to ten members, assemble the whole car themselves. The time duration of the individual work tasks were now a couple of hours.

Below, the steps of the trajectory are described one by one. The steps show how the new production and learning principles were integrated in the thinking of the planning group. In the beginning, the ideas were simply beautiful words, which seemed to be unattainable goals, but in the end they were realized. It is clear that the development was slow when compared to a traditional planning process, but on the other hand, it was very creative and successful.

3.2 May 1985 – quite a traditional layout: 'Not good enough'

In May of 1985, half a year after the initial meeting, the planning group had to present a layout for a complete automobile plant which include a body shop, a paint shop and an assembly shop. The group presented a sketch of a factory layout which emphasized the goals for the factory.

The assembly shop, however, remained quite traditional. For example, in this layout the product flow in the assembly shop was more or less similar to that in the Volvo Kalmar assembly plant. There were two minute work

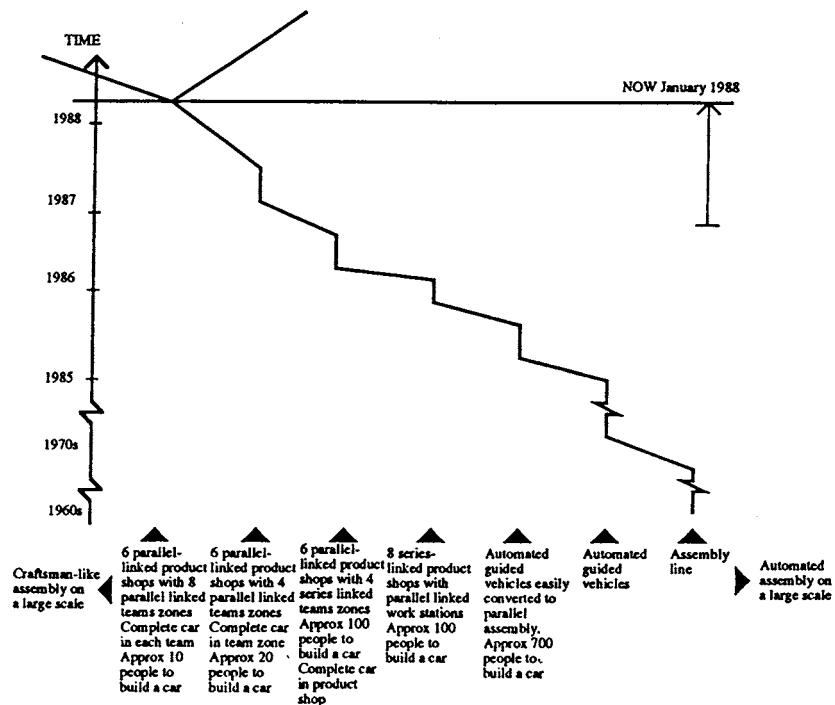

Figure 1. Illustration of the trajectory describing the movements of the Volvo trajectory (line V), during the planning process of the Uddevalla plant. The model has a time dimension and a dimension of production mode. The end points of the horizontal dimension is the idea of automatized assembly on a large scale on one hand and the idea of ‘craftmans like’ assembly on large scale, on the other. The position of the planning in January of 1988, is shown by the angle touching the line NOW: January, 1988. The trajectory shows clearly the steps in the planning process that are described in more detail in the text. The first layout for the Uddevalla plant would have meant that about 700 persons should have assembled each car together. The layout in January of 1988 meant that 8 persons made one car.

cycles in a serial flow, which were meant to be changed into a partly parallel flow later on. Whereby 700 persons together should have the competence to build a car with opportunities for the assemblers to learn about 10 work cycles, of approximately 20 minutes of work.

Many members in the planning group, among them the union representatives, did not find this layout corresponding to the goals set up. It was important to reach an agreement, as one of the goals set up for the Uddevalla factory was that the planning process itself should improve the cooperation between the company and the unions. The unions refused to acknowledge this traditional layout as something better than existing other factories. The top management at Volvo were of the same opinion. This layout was rejected at a planning meeting. A new layout, in better accordance with the initial goals set up for the factory was sought. Furthermore, environmental pollution emissions had to be considered.

3.3 December 1985 – the start of something really new

Half a year later, in December of 1985, the planning group had worked out a new layout. The general ideas of smaller organizational units, parallel work stations and extended work cycles were integrated in the layout. According to this layout, the assembly plant should be divided into eight series-linked product shops. In each product shop one eighth of the car should be assembled, and each product shop was to be an independent unit in the organization. Within the eight product shops, the work stations were to be parallel. This meant that all assembly work performed in each product shop (i.e., one eighth of the car) should be done on one single station per car. See figure 2.

The car should stand still in a 'dock-station' during the assembly, with pairs of assemblers doing all assembly work at each parallel station. Not only assembly work should be performed in the product shops, but also, much of the materials handling. The materials handling should be performed on another floor of the building. The work tasks would thus become more varied. Whereby, each employee would be responsible not only for assembly, but also for materials handling related to the assembly task at hand. This meant that the work cycle for every assembler should increase to about 15–20 minutes on every car (6). Thus, this layout presented to the steering committee in December of 1985, presented something really new.

The assembly plant was meant to be located in and upon the big shipyard dock. It would become very expensive to control the level of moisture in the ship yard dock. The planning group still did not receive an answer from the authorities, concerning the negotiations regarding polluting emissions from the factory. These circumstances resulted in the steering committee's request for a less expensive layout: one which made use of pre-existing buildings on the ship yard land area, and did not use the dock.

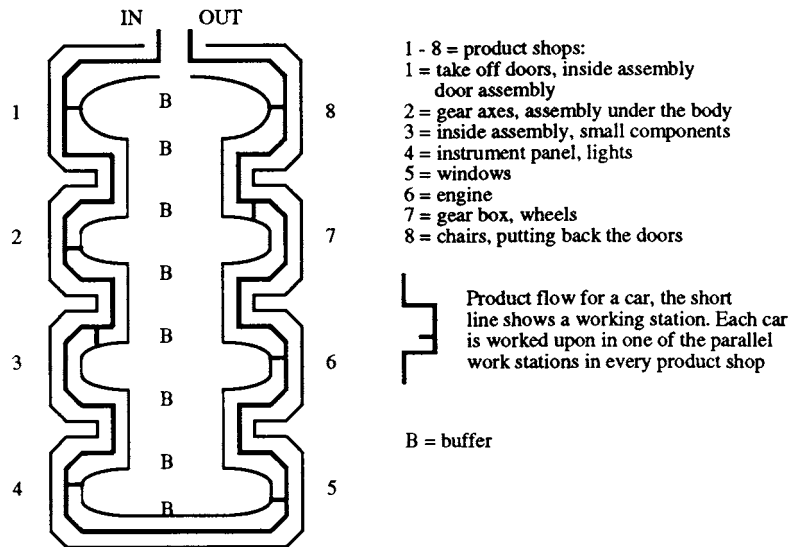

Figure 2. The second layout was something new (December, 1985). The car should pass one work station in each one of eight series inked product shops. On each of these stations (the stations within the product shop were parallel), all work was to be performed by a pair of car builders, who also were responsible for their own materials handling.

At the end of one year of planning an acceptable layout was not yet found. Negotiations regarding emissions also slowed the process. The result was an opportunity for a unique type of factory, previous unknown to the automobile industry.

3.4 Putting the assembly line into history

This opportunity was felt, 'in the air' by the project leader. He set up a small sub-group, with a couple of free-thinking technicians and one union representative. Together they produced a layout based on the two main ideas from the researchers.

One of them favoured parallel product flow and a materials handling according to the flow. Which meant that the material to be handled were 'car-related' and not primarily related to a geographical area in the factory. The other idea focused on the human's ability to learn huge work tasks when an overview of the production process and understanding of it as a whole are emphasized. This occurs when one has control over the working order and working pace, as well as finding meaning in the work. It had already been

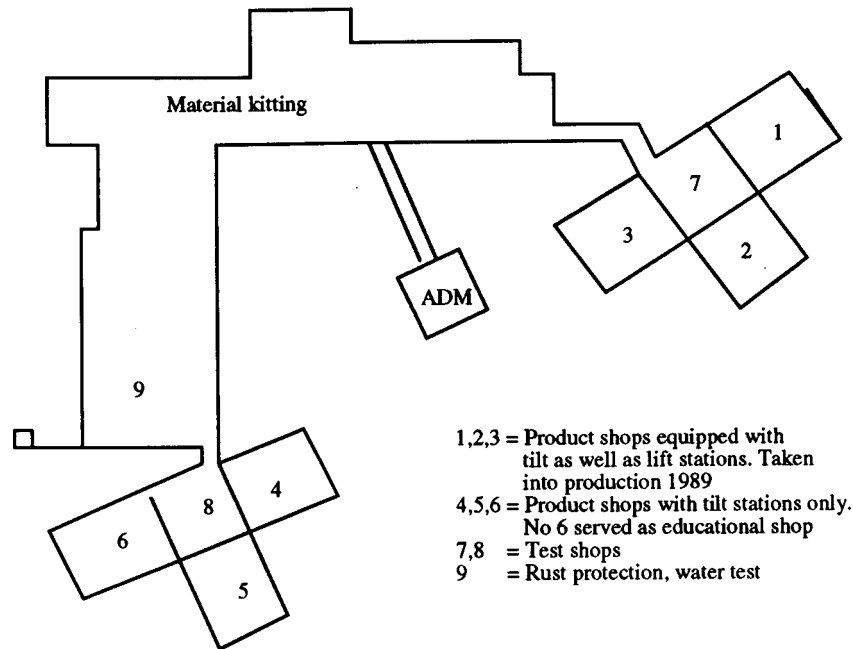

Figure 3. The shape of the Uddevalla plant at the final decision to start building the plant. Six parallel product shops (no 1. to 6. in the figure), two test shops (no 7. and 8.) and one rust protection shop (no 9.), and one central shop for material handling.

theoretically shown that, the smallest content of a work task in car assembly that fills these criterias is approximately one quarter of a car. These were the basic starting points for the subgroup.

An important result from the subgroup work was that the small, independent organizational units, the product shops, were proposed not be linked in a serial flow. On the contrary they should be independent of each other. This meant that they should be parallel, and thus that whole cars should be built in each one of them. This was manifested by the location of the buildings, as one separate house was to be built for every product shop. This was a radical change compared to the earlier layouts put up by the planning group.

3.5 June 1986 – The buildings support the idea of parallel product shops

These ideas were identified by the rest of the planning group as interesting and progressive, and they were involved in the further development. One point, however made some persons anxious. That was the lack of opportunities to return to a serial flow – if the new production system should not

work. In the final layout given to the steering committee in June of 1986, the independent product shops were placed corner to corner in two three-clover leaf configurations. See figure 3. In that way, it was possible, but expensive, to return from the highly parallel flow to a serial flow of a more traditional kind. All materials handling means, in a car factory relying on the principles of reflective production, preparation of individual sets of materials for each individual car. These were to be performed in an existing building from the ship yard era. This meant that there was a physical separation between material preparation and assembly.

Some months before the decision was made to build an assembly factory according to this layout, it was also decided that no body or paint shop should be built. The main reason was that there still was no answer from the authorities regarding the negotiations about the permitted level of pollution emissions. Another reason was that the cost of the paint shop was very high.

3.6 The educational work shop – testing the theoretical statements

All creative efforts were now concentrated to plan an assembly plant well meeting the goals. The researchers in technology and educational science had already given their view of how to do this. Theoretically, it was shown that the time use for assembling a car should be much shorter in a highly parallel product flow, than in a serial flow (7). Theoretically it was also shown that learning was facilitated (much more effective) if it contributed to the understanding of the car as a whole and which had meaning to the learner (8). The big question remained if these theoretical truths correspond to what would appear in the real world, when the principles were put into practice.

This question was answered when the educational workshop was started in spring of 1986. The first 20 carbuilders were deeply involved in planning and equipage of the educational workshop. Work methods were tried, as they learned the work content of at least one quarter of a cars assembly. Not one of these carbuilders had worked in the automobile industry before.

In the educational workshop the carbuilders then proved that it was possible to learn very quickly, how to assemble one quarter of a car, and to assemble it with high quality. There were two main reasons for this. The first, is that all materials to each individual car were placed in prepared sets on stands defined for that car only. The second, is that the materials on the stands were grouped and arranged in such a way that the assembly work was facilitated.

Some months later, all car builders mastered one quarter of a car, many of them half the car and others still had achieved three quarters of a car. Some time later, in the educational workshop, one or two car builders were able to build the whole car themselves.

When the decision was made to build an assembly plant in Uddevalla, the planning group knew that they would succeed if they kept the buildings, equipment and learning according to the principles. In June of 1986, the final decision to build the Uddevalla factory was made, after which no substantial changes were made in respect to buildings, but there were great changes in the product shop layout. This process was constantly fed with arguments based on experiences from the educational workshop. In it, new ideas and improvements were tried out. The competence to build a whole complete car was, step by step, geographically concentrated.

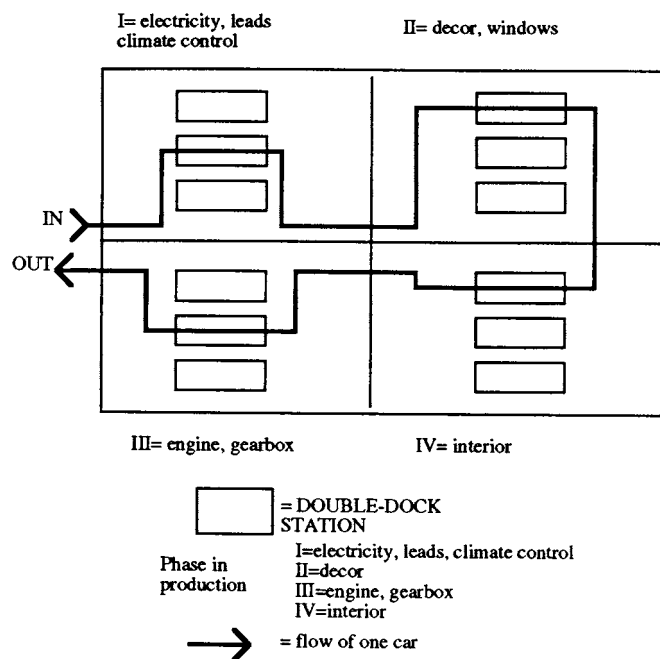

Figure 4. Product flow through one of the six product shops (the other ones were intended to be the same), the layout in June of 1986. Whole cars in product shop, one car is made by 80 persons. The four quarters of the car (I. Leads, II. Decor, III. Drive line and IV. Interior), define the content of the work in each team zone (that is in 1/4 of the product shop. Two teams constitute each team zone).

3.7 Whole cars in a product shop: one car is made by 80 persons

In each of the six parallel product shops whole cars should be built, according to the layout presented in June of 1986. In each product shop, the total assembly work was divided into the four quarters of the car, and each

quarter was to be built in a separate area (9). The four separate areas were series linked and called 'team-zones'. That meant that; one quarter of the product shop was equipped for assembling the first quarter of the car, leads (electricity and water and other fluids), the next quarter for decor (ceiling, windows etc), the third quarter for the drive line (engine, gear etc) and the final quarter for the interior (chairs, steering wheel etc). See figure 4. These four areas in the product shop were labeled 'team-zones', and there were two teams in each of them. This constituted approximately 80 employees in a product shop with four team zones.

The work stations within the separate series linked team-zones were parallel. A pair of workers did all the assembly (one quarter of a car) on one station and when they had finished their quarter they sent the car to the next team-zone, where the next quarter of the car was to be assembled. When the whole car was ready, it had passed through all four team-zones, and one work station within each team zone.

3.8 Whole cars in a team-zone: one car is made by about 20 persons

In January of 1987, the planning group realized that the production arranged according to the June 1986 plan, still gave only a limited overview of the assembly to the workers. They had no immediate feedback as to the consequences of their work. Why not then, concentrate the assembly work and build the complete car in a team-zone, i.e., in one quarter of the product shop? None of the buildings were equipped as yet, so this change was not expensive. The planning group decided to follow the idea, and thus there were four parallel team zones in each product shop. In each team zone about 20 persons assembled the whole car. See figure 5. Their parallel work stations were equipped for each quarter of the car. The area in the building was a decisive restriction. However, when this layout was related to the production volume required, it was clear that it would not meet the requirements of 40,000 cars per year, in one shift.

3.9 Whole cars in the team I:

One car is made by 8 persons on two work stations

Because of the restricted area, it was now necessary to use even less space to reach the production volume required. This could only be done by geographically concentrating work tasks even further. The results showed that a car should be built on two stations only, with half the car assembled at each station. The first three product shops in the Uddevalla factory were equipped according to this layout. See figure 6. When production ceased in 1993, the production pattern still was the same in these three product shops.

3.10 Ergonomic arguments for efficiency

If a work task is easily performed, it also can be effectively performed, though much can be related to mental efforts. Variations in the work tasks are good for the human body and mind. Such questions were discussed in the planning group and the group pointed out that one central component in work is related to ergonomics. The planning group made great efforts to improve the ergonomics at work in the Uddevalla plant. Less repetitive work tasks (i.e., long work tasks of about two hours), is one result. When you repeat the same task only four times a day, your body does not get worn out as quickly as if you have to repeat the same task more than 200 times a day. Another effort was the development of hand machines adapted to the hand size of women (10).

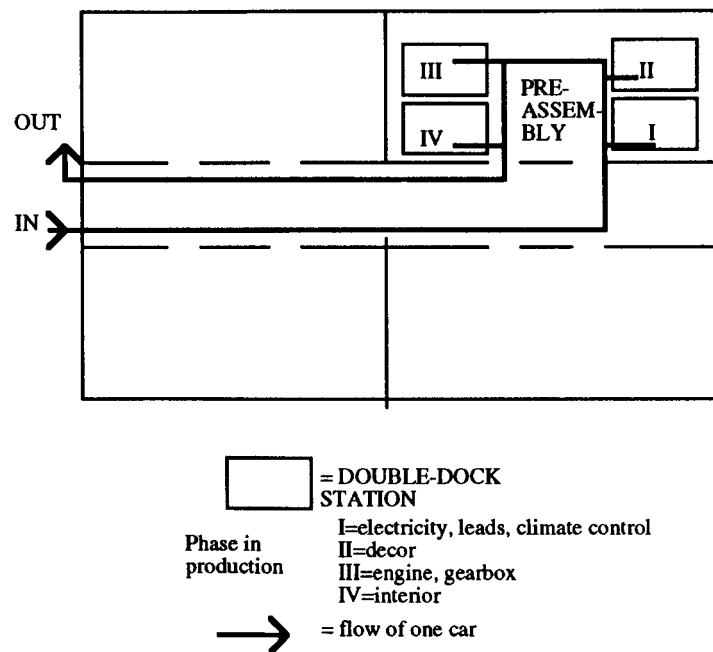

Figure 5. Product flow through one of the team zones in the layout from January of 1987. Whole cars in team zone, one car is made by 20 persons. This layout is principally the same as the previous one, but the scale is changed and now four parallel team zones make complete cars in each product shop.

The ergonomic argument also was relevant for the way the assembly tasks are performed. In ordinary assembly work, only 20 percent of the work in the tasks are performed standing in an upright position. The remaining 80 percent of the work, is performed bent or standing with hands above the head. The ergonomics of assembly work was improved in the first three product shops in Uddevalla, but further improvements were still possible to achieve.

It was clearly demonstrated that when ergonomics are improved, according to the principles of reflective production, the result is not only a 'good work' for the employees, but also a more efficient production performance in the plant.

3.11 Whole cars in the team II:

One car is made by 8 persons on one station

A small group of carbuilders had the opportunity to develop a completely new ergonomic and at least as efficient, way of performing the assembly work. They worked together with a health care engineer. The way to build cars that they developed involved still another change in the basic layout of the product shop, as the complete car now could be assembled at only one station. That station should be equipped with a 'tilt', which made it possible not only to lift the car body, but also to turn it 90 degrees in both directions. This made it possible to perform the work tasks more efficiently and lowered the risk for personal injuries. Thus, the three product shops that were to be started after 1989, now were equipped according to this way of building cars. Therefore the Uddevalla factory continued to be innovative even after production started in 1989.

This layout did not only result in better ergonomics, it also allowed a greater flexibility concerning how the assembly work could be performed. In this later layout, each team remained the same size as before (about eight members), and could easily divide itself into subgroups. Where one pair of individuals could master the whole car, they could form one subgroup, use one of the tilt-stations, and build cars themselves. At the same time the other members of the team, forming another subgroup, assemble the cars according to their competence and following another work distribution rule.

3.12 A comparative perspective on the result of the planning process

Now it is possible to place a developmental perspective within the planning process and compare the two different types of assembly work.

- I. A complete car is assembled at one station, by a team of about eight persons.
- II. A complete car is assembled at about 200 series linked stations by 700 persons.

There are some obvious conclusions to be drawn from this comparison.

Firstly, the workers individual competence must be greater in the first case, as the capability to build a whole car is spread over only eight persons. In the second case, the same competence is divided by 700 individuals. Secondly, the possibility to achieve an overview of the assembly is much greater in the first case, as the car stands in the area of the same team during the entire assembly. Thus feedback is facilitated if any problems occur that are related to the assembly done earlier.

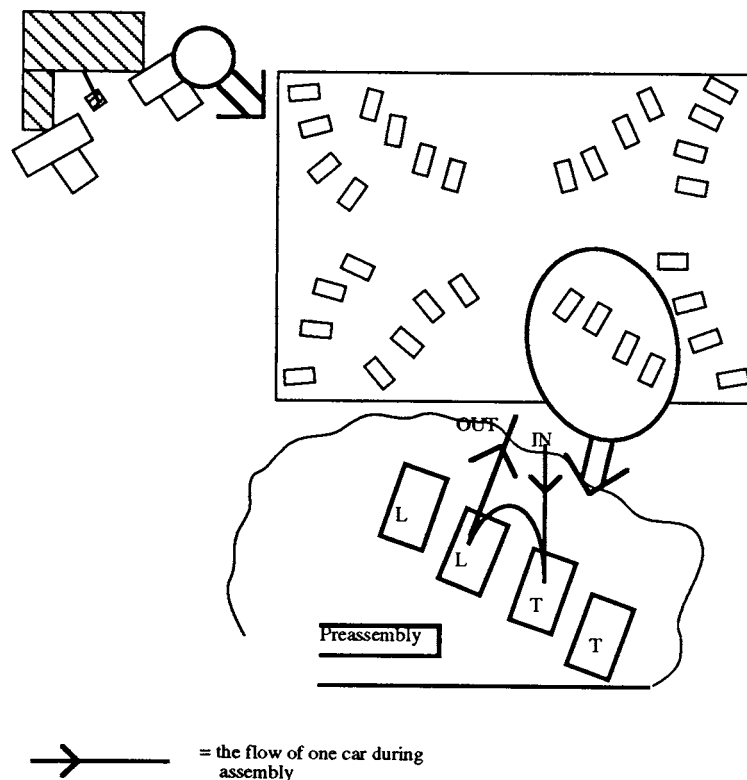

Figure 6. The layout of the complete Uddevalla plant from which the layout of one product shop is focused in which the layout of a team's area is presented in detail (January, 1988). The team has four work stations at its disposal, but only two of them, one lift station and one tiltstation, are used for an individual car. A pair of car builders work on one tilt-station and they build half the car, then the car is moved over to one of the two lift-stations in the team's area, where another pair of workers build the other half of the car.

4. Which were the results achieved by the new plant?

The results achieved by the new plant can be focused upon from different perspectives. Due to the closure of the factory in Uddevalla, only short term effects could be observed, though there are several indications of favourable long term potential as well. Focus will be put on competence and organisation, firstly on the results in the short run and secondly the long run potentials.

4.1 The performance of the Uddevalla plant: Competence

Work content

In most assembly plants there are short cycle work tasks of about one to two minutes in duration. One such cycle is called a 'balance'. 'Multiskilled' workers on an assembly line are responsible for up to ten 'balances', which means that they have a good command of about 20 minutes of assembly work. In these plants, the assembly line controls the pace and work is measured by the number of minutes, and not by its content related to the total assembly of a car. In the Uddevalla plant, all workers knew how to assemble at least one quarter of a car, which means that all workers controlled the assembly of at least one 'assembly-functional group of materials'. One quarter of a car equals about two hours of work. One point in a 'reflective production system', is that work content is superior to time. Other competence derived fundamentals are the understanding of a meaningful whole, overview over the work object and tasks of the work day. Also, that control over the work distribution and pace in the teams is essential for a successful result. All this means that quality is what matters most, time and volume are mere restrictions.

Flexibility at work

In the Uddevalla factory there was a great flexibility concerning competence and work performance. It was possible, although it was not common, for teams to form subgroups. It was easier in the newer product shops, those who were equipped according to the ergonomic/efficiency idea, where the car was completed on one work station, than in the three older product shops where the car was assembled on two different work stations. As indicated above it was possible for two persons to assemble the whole car, if they had the appropriate competence.

In addition, when the Uddevalla factory closed down, approximately 25 persons mastered the assembling of a complete car, with high quality and within the full production pace. In fact they could control the same work content that is distributed over hundreds of persons in an assembly line factory. In such a comparative perspective, the results in Uddevalla reveal that

the basic competence equals the competence of at least 60 workers taken together in a plant with an assembly line.

Improving competence

Improving competence is a fundamental task in industry. In the beginning of the Uddevalla factory's production, there were problems other than those which appear in a factory with a serial product flow. The unusual parallel flow pattern in Uddevalla caused some problems in the beginning. First, there were some problems related to the independence between the parallel teams in the product shops, making the diffusion of improvements difficult. Second, there were problems related to the independence between the parallel product shops, each of them eager to create a productive milieu by itself.

There were also problems caused by the high level of dependence between the material shops and the product shops as they were linked to each other in a serial flow. The problems that appeared between the teams and between the product shops respectively, were mainly caused by the absence of a smooth information flow. Two measures were taken which led to success. One of them, was to flatten the organization in the plant, so that the product shop leaders, all were put into the leading group of the factory (only three levels in the plant). This gave the product shop and the material shop leaders better insights into each others working conditions and bottle neck problems. The second measure, aimed at improving the diffusion of experiences and new and better ways to arrange the assembly work. Here, the production technicians were decentralized into the product shops, where their work time was divided between two tasks. One, was to do their production technical work in the office and to keep in touch with and spread improvements to the other parts of the entire factory. The other work task to be performed by the technicians, was to work with the teams in their product shop, in the assembly work. This made them more skilled in the various assembly tasks and made them think in 'real categories' rather than in 'administrative categories'. In this way, a process of very rapid and well structured improvements in the entire factory was started. Some good results were yielded immediately and the probability of more seemed likely to come.

Employment strategy

The employment strategy used was closely related to the principles of competence growth and competence utilization. The strategy was also meant to lead to a reduction in sick leave and an increase in teamwork. The personnel in the Uddevalla factory were brought together in several ways. There were about 40 percent women, a blend of ages, and in the beginning Volvo looked for former shipyard workers. The goal was to employ 25 per-cent of

the employees of the age of 25 years and younger, 50 percent between 25 and 45 years and another 25 percent over 45 years of age, and 40 percent were to be women. Each team was composed so that both sexes and more than one age group were represented. The aim was to make use of the fact that people are different and that they have different positive and negative qualities. The sick leave was lower than in other factories in the Swedish auto industry, but not as low as many persons had hoped, during the planning phase.

Flat organization

The objective was to form a flat organization in the Uddevalla factory. In the beginning there were four levels in the organizational scheme; plant manager, production leader, product shop leaders and teams. During the last year of the life of the factory, there were only three levels namely, plant manager, product shop leaders and teams. Therefore, the flow of information between the top manager and the shop floor was very rapid, compared to any other assembly plant.

In the product shops, the teams were put in focus. There were eight teams in every product shop. In the teams there were two kinds of tasks to be met by the team members. The most important one was car building, as there would be no plant without production. All team members thus were car builders. There were also complementary specialist tasks to be mastered by the teams. Team members who had expressed interest in performing specialist tasks, were taught to perform these tasks. The tasks were for example, personnel issues (information, recruitment and planned days off), as well as maintenance and teaching. There was also a role as team leader, who performed most of the work tasks done by foremen in traditional factories. The team leader was appointed by the team members and the product shop leader together. The team leader role was rotated among the team members, who had acquired the relevant competence and skills required for the role. The team leader as well as the other specialists of each team were all involved in the car building during most of the working day.

As indicated above, each product shop had a production technician, who was the most skilled specialist in technical aspects related to the product shop. The technician was also responsible for spreading technical as well as organizational improvements, to all teams in the product shop and to his/her colleagues, as well as to the production technicians in the other product shops. To succeed and keep his or her own practical knowledge in car building up to date, the technicians worked in the teams for a portion of every week.

The wage system was created to increase according to additional competence. There was also a basic wage, dependent on the time worked at the job and the individual skills in basic car building. Extra pay for increased

competence in car building was added per hour for every additional quarter of the car mastered in assembly. In addition to this, there was extra amount for each specialist competence (personnel, technician, maintenance and teaching), and for the team leader competence. Then there was also a bonus system (measured on quality and quantity), based on the team performance.

Comments on quality, production volume, productivity and model changes

The *quality* index followed a positive curve from 1988 (before the opening of the factory), up till the closure of the plant. The highest quality ratings occurred during the spring of 1993, the period when people knew that they would be unemployed within some months.

Due to the falling sales figures for Volvo during the period when the Uddevalla factory was fully trimmed in, the *production volume* never reached the total capacity level. But, the figures in the production plans were achieved.

The *productivity* showed a positive development. In the autumn of 1992, before the decision to close the factory was made, the productivity figures for some weeks was far better in the Uddevalla plant than in the old Torslanda plant.

The Uddevalla factory was the most successful in *changing from one year model* to the next. The same results appear whether you compare time or costs for the changes. The Uddevalla factory made the fastest changes, three years in a row and the factory also made the changes to the lowest cost per car. This is due to the high competence level and the low level of mechanization.

4.2 Potentials of 'Reflective Production Systems' indicated by the Uddevalla plant

Some long-term potentials, derived from the 'Reflective Production System', were fit for use in Uddevalla during the last half year, before the decision to close down the factory. Revolutionary steps were taken in relation to the market. First, the factory only produced cars that were already sold. No stock cars at all were being produced in the Uddevalla factory during this period. Second, a number of customers were invited to follow the production of the car they had bought. This procedure was favourable for Volvo. Where else in the world could a customer follow the birth of his own car, and get an overview over the process? It was also favourable to the customer to receive the personal touch, which strengthened the incentives for the teams to make superior quality. It was also favourable to the team, who have personal relations with a customer which made the job still more stimulating.

The production planning in the factory was a factor of flexibility and right time delivery. The customer could make changes in his order to the factory,

for example orders for new special options, and this resulted in negligible delays. Changes in orders did not cause the replanning of the entire production program, or to put the changed car at the end of the production program. Any of these actions would cause delays in delivery. Thus, the production planning could be used as a tool for flexibility, and it made it easier to produce cars exactly adapted to the demand of the customers.

Another long term potential concerns the relation between production and preproduction, which is a field of increasing importance in the automobile industry. The Uddevalla factory had unique possibilities to use the complex and skilled knowledge of all its competent team members in order to improve products as well as, tools and processes. This potentiality becomes clear only to those who adopt the thinking behind the 'Reflective Production System'. Others, will not be able to recognize it. They will think rather that the 'Reflective Production System' is at best, a local Swedish improvement in production for social purposes. It indeed was true that the social factors worked in favour of the Uddevalla factory, but it also proved to be a good investment for high productivity, effectivity and flexibility.

5. Concluding remarks on reflective production

In this paper the presentation of the principles of the new 'Reflective Production System' is not made in a theoretical way. Instead, there has been a concrete description of the long and adventurous way in which it was developed and utilized. Some of its problems and advantages were demonstrated. The importance of competence was emphasized, based on holistic learning in combination with a production technology adjusted to the ways in which individuals think, learn and act in industrial work. The paper will be closed with two examples, showing the necessity to think in new ways if a company wants to lead the way into the future of the automobile industry.

The majority of those within the Volvo company in Gothenburg were not motivated by the principles underlying the 'Reflective Production System'. During the entire history of the Uddevalla plant there had been a struggle both within the company, and within the unions, a struggle much like that between different religious groups or actors. The basic problem is that the two ways of reasoning (the serial flow on an assembly line compared to the parallel flow in production teams in the Uddevalla plant), may very well use the same set of measures for evaluation, but they lean on fundamentally different basic assumptions. If the evaluations reveal that the results from the old factory and the new factory are equally good, then the fundamental assumptions behind these could be of decisive importance in the final conclusion about how to act.

A person who does not accept the principles underlying the 'Reflective

Production System' realized in the Uddevalla plant, of course can not see its immanent potentials, since the 'Reflective Production System' as a whole contradicts his basic assumptions. These potentials, however, are immediately clear to a person convinced of the correctness of the basic principles of the Uddevalla factory.

Finally, I will recall an interesting remark made in the spring of 1993, by one openminded first time visitor to the Uddevalla factory. During the visit, one of the car builders, who had the competence to build the whole car himself, asked his work mates to cover his eyes with a scarf. He then asked the visitor to get anything from the material stands in the team area. The visitor chose after a while a small thing and gave it to the car builder who said, after having felt the thing over with his fingers: 'This was easy! Get me to the engine'. And there he placed the thing in its right position, still with his eyes covered. Then the visitor exclaimed: 'Is it hocus pocus? Or is it that easy?'

Notes

1. There is a detailed description in Swedish of the principles behind the production system in Ellegård, Engström, Johansson, Medbo and Nilsson, 1992, Reflektiv produktion. Industriell verksamhet i förändring, and a shorter description in English in Ellegård, Engström och Nilsson (1989), Reforming industrial work – Principles and Realities in the planning of Volvo's car assembly plant in Uddevalla.
2. Uddevalla is a town located on the Swedish west coast, some 90 km north of Gothenburg where Volvo's oldest factory is located. The decision to locate the factory in Uddevalla was strongly influenced by the fact that the state owned shipyard there was closed down in 1984 and more than 2,000 people were unemployed.
3. Somewhere between 1,800 and 2,400 objects make up each single car.
4. This holds true for example, concerning high sick leave or materials missing, even if such a problem occurs only at one single station on the assembly line.
5. There were one blue collar union and three white collar unions involved.
6. This work cycle duration corresponds to the demands from the metal workers union set up in the spring of 1985.
7. See for example Engström and Medbo,1990, and Wild,1975, and Ellegård, Engström, Johansson, Medbo and Nilsson,1992.
8. See Nilsson, 1985, and Ellegård, Engström, Johansson, Medbo and Nilsson, 1992.
9. The four quarters were labeled: 1. Leads, 2. Decor, 3. Drive line and 4. Interior.

10. In the Uddevalla factory, at least 40 percent of the work force were female.
11. Not more than two team members assemble the same car at the same time. Each team has four work stations at its disposal.

References

- Alvstam, C. and Ellegård, K. (1990), 'The organization of work: a determinant of the future location of manufacturing enterprises: The case of the new Volvo plant in Uddevalla, Sweden.' in M de Smith och E Wever (ed.), *The Corporate Firm in a Turbulent Environment. Case Studies in the Geography of Enterprise*. Routledge. London.
- Ellegård, K. (1991), 'Volvo's Planning of the Automobile Factory of the Future – A Process of Continual Reform.' in Y. Quénnec and F. Daniellou (ed.), *Designing for Everyone*. Proceedings of the 11th Congress of the International Ergonomics Association in Paris. Taylor and Francis. London.
- Ellegård, K., Engström, T. and Nilsson, L. (1991), *Principles and Realities in the Reform of Industrial Work – the planning of Volvo's car assembly plant in Uddevalla*. The Swedish Work Environment Fund. Stockholm.
- Ellegård, K., Engström, T., Johansson, B., Medbo, L. and Nilsson, L. (1992), *Reflektiv Produktion. Industriell verksamhet i förändring*. AB Volvo. Göteborg.
- Ellegård, K., Engström, T., Johansson, B., Johansson, M., Jonsson, D. and Medbo, L. (1991), 'The possibilities of "Lean Production" – A Comparison between Different Production Flow Concepts in the Automotive Industry.' *International Journal of Operations and Production Management*, vol.12, no.7/8. MCB University Press.
- Ellegård, K. (1989), *Akrobatik i tidens väv. En dokumentation av projekteringen av Volvos bilfabrik i Uddevalla*. Choros no. 1989:2. Kulturgeografiska institutionen, Handelshögskolan vid Göteborgs universitet. Göteborg.
- Ellegård, K., Engström, T. and Nilsson, L. (1989), *Principer och realiteter vid förnyelse av industriellt arbete. Projekteringen av Volvos bilfabrik i Uddevalla. Sammanfattning av forskningsprojektet "Dokumentation av utvecklingsprocessen för Volvos Uddevallafabrik 1985–1988*. Arbetsmiljöfonden. Stockholm.
- Ellegård, K. (1989), *Metalls medverkan i projekteringen av Volvos Uddevallafabrik*. Svenska Metallindustriarbetareförbundet. Stockholm.
- Engström, T. and Medbo, L. (1990), 'Material flow analysis, sociotechnology and natural grouped assembly work for automobiles and trucks'. 1990. Proceedings from *European workshop – research and development strategies in the field of work and technology*. Dortmund 1990. Physica Verlag, Heidelberg.
- Nilsson, L. (1985), *Naturligt arbete och industriellt lärande*. Institutionen för pedagogik. Göteborgs universitet. Göteborg.
- Wild, R. (1975), 'On selection of mass production systems'. *International Journal of Production Research*.

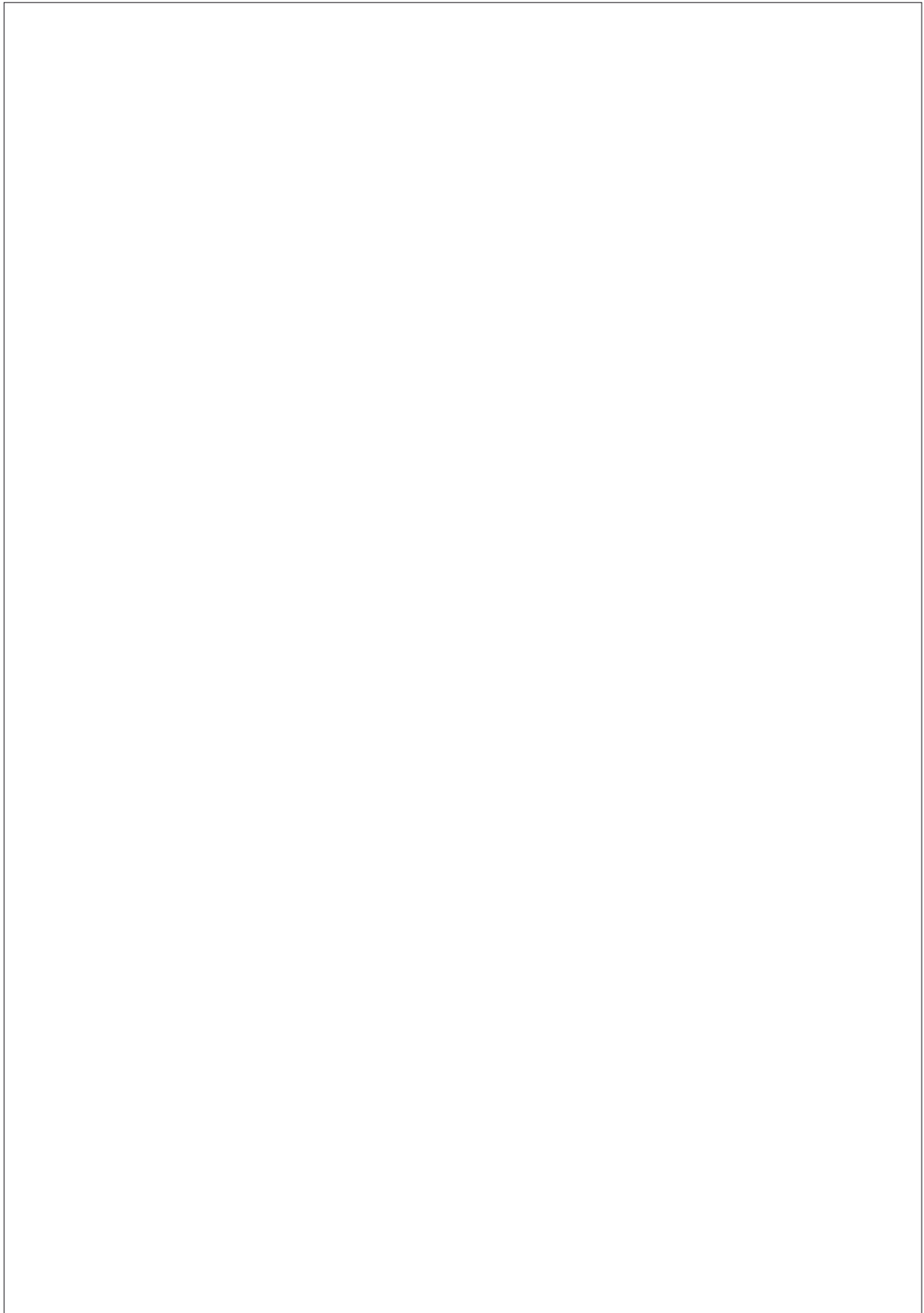

Production system design – a brief summary of some Swedish design efforts

Tomas Engström and Lars Medbo

1. Introduction

Production system design traditionally includes aspects connected to the materials flow patterns inside the factory. Therefore, the design process of the production system includes, for example, problem areas such as work place design, layout planning, materials flow analysis, etc.

For example, concerning the manufacturing of components using expensive production equipment, the design process will focus, among other things, on the utilization of the individual machines, as well as, introducing methods such as group technology, mechanization of the materials handling between the machines, etc. If, on the other hand, components are assembled into complete products, as is the case in the final assembly of vehicles, it becomes important to better utilize the human being in order to reduce the required manpower. The design process will, therefore, focus on: balancing methods, ‘just-in-time techniques’, etc.

The system design of production systems for final assembly, has in many cases, consisted of a process of refining the existing production systems, i.e. the traditional assembly line, rather than implementing non-traditional production principles. This is due to the risks involved as well as intellectual barriers to some extent (Granath, 1991).

We argue that today there exists an empirically tested coherent theory of how to design non-traditional production systems for final assembly of large products, such as yachts, trucks, buses and automobiles. However, this theory has not been fully recognized and communicated at an international level. In most cases, this is probably due to the fact that Swedish efforts are generally considered and presented as social experiments, assumed to be isolated from important technical dimensions, like materials flow pattern, materials feeding techniques, etc.

2. A brief history

At the beginning of the 1970's, the most radical changes in assembly work took place within the manufacturing of trucks. A very similar production system was used at Volvo in Sweden in the small Volvo Arendal work shop and at British Leyland in the United Kingdom (Blackler and Brown, 1978). In British Leyland's production system, a group of 12 workers assembled complete trucks.

The Arendal workshop proved to have a superior productivity and product quality. At that time there was no valid theoretical explanation for this phenomenon. A general theoretical analysis had been performed in the Volvo Car Corporation (Rosengren, 1981), but these were not generally recognized. This production system was in many aspects identical to the one introduced by the Volvo Truck Corporation several years later, that of a parallel flow with integrated sub-assembly, characterized by unpaced high-autonomy, collective work. The parallelized flow means that the flow of products is parallel instead of in a series, as is the case with the traditional assembly line, thus increasing the cycle time (the amount of time required to complete one work task in repetitive work).

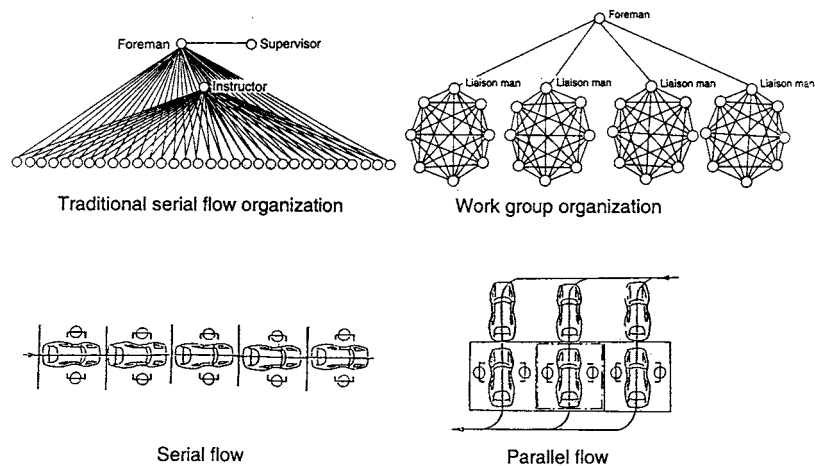

Figure 1. The Saab-Scania body shop in Trollhättan was changed from serial flow to parallel flow, thus increasing the productivity and the technical autonomy. Paradoxically, it became possible to simultaneously combine efficiency and humanized work (Karlsson, 1979). The organization was reformed to suit the technical preconditions determined by the changed technical dimensions.

The most prominent example of an alternative production system was implemented during the mid-1970s in the Saab-Scania body shop in Trollhättan. Note that in a body shop the work consists of grinding and welding on the naked automobile body. Thus, one does not need to supply a large number of components, as is the case in final assembly. Therefore, the most crucial research task was to develop methods for supplying materials to parallelized flow production systems.

In theory and in a number of case studies, it later proved to be both practical and economically viable to supply materials to large products in parallelized flow. This was achieved by using kitting of the materials and a combination of decentralized and centralized materials stores (Engström and Karlsson, 1982; Engström, 1983).

Although this possibility existed, the traditional materials feeding techniques (methods used to supply the components needed for the assembly work) and the need to use both the traditional assembly line and the alternatives simultaneously in the same plant, led to the development and implementation of the so-called 'mini-lines' at Saab Scania in Trollhättan.

This was a serial flow production system with intermediate buffers, integrated sub-assembly stations and the possibility to continuously regulate the pace of the line. Thus, it was possible to use traditional materials feeding techniques. These 'mini-lines' appear to be similar to those implemented in the Japanese factories at Kyushu and Tahara almost ten years later.

The Volvo Uddevalla final assembly plant which ran between 1987–93, was the latest full-scale example of a practical application of the design theories of non-traditional production systems. In fact, the Uddevalla plant provided the last key elements needed to complete the theory and its application.

While the 'mini-lines' were a compromise, concerning the materials feeding techniques, among other things, the Uddevalla plant, on the other hand, was an example of an inverted design process. By turning the design process the other way around, i.e., starting the design process from scratch, some of the generally accepted traditional design criteria were transformed into methods. For example, long cycle time and parallelization were methods used for achieving high productivity and quality, as well as flexibility. Long cycle time was not considered as a goal in itself.

The original phrasing of the research area during the 1970's, as a materials feeding restriction against parallelization, originated in dialogues with representatives from the automotive industry. This was somewhat misleading but relevant during the early period. The components needed for a single product were perceived to be far too many, thus requiring far too much space provided the materials were to be exposed on a work station using traditional materials feeding techniques.

It was therefore assumed to be impossible to supply the components

needed for complete automobile assembly on a work station. This was partly due to the fact that the all-embracing information system in the Volvo corporation deformed the product perception emanating from the designers' product structure. This also implied an enormous amount of product variants. (The product structure is the way information on the product is organized in the information system by using numerical, alphabetical and verbal codes in a hierarchy).

During the design of the Uddevalla plant these assumptions proved to be false. Although extensive analyses of the real product and its traditional representations in the information system had been carried out, further analyses as described below was required.

Another critical restriction towards parallelization during the 1970s was learning. How could it be possible to learn the tasks in an extended cycle without prolonged training? The generally accepted assumption, according to traditional learning theory (Argote, 1990; Wright, 1936), was that the shorter the cycle time, the shorter the learning process and the more efficient the work.

3. The design method used for the Volvo Uddevalla final assembly plant

During the 1970s and 1980s, automobiles and trucks were assumed to be difficult to understand from an assembly point of view. In retrospect, this assumption was incorrect. It is now clear that the product structure used today by most Swedish automotive manufacturers, leads both researchers and practitioners to erroneous conclusions.

This explains why the efforts of researchers, despite comprehensive empirical and theoretical analyses, did not achieve penetration in the largest industrial systems during the 1970s. It did not matter if one knew how to do it – it had to be proven and explained using the nomenclatures familiar to the practitioners. Hence, methods such as disassembly of complete products, the use of prototypes of materials handling equipment, prototypes of information systems using computer print-outs, etc., were used. In fact, it proved necessary to use a large experimental work shop for the six-year period between 1985–91.

The shop was filled with automobiles and trucks in various stages of disassembly, as well as equipment for the manufacturing of prototypes of materials handling equipment. The facilities also included full computerized support connected to the centralized data banks at the Volvo Truck and Car Corporations.

It was necessary to disassemble products, since we needed to understand the real products as well as the corresponding computerized formalization

and different documents published by the design department or the central process engineering department. This was a time-consuming and mentally trying process, because of the inconsistent and often poor quality data.

We were able to translate the product structure and information received from the design and manufacturing engineering departments into a final assembly-oriented product structure. The method used was to compare computer print-outs and actual components, and to modify the structure in accordance with the disassembly and assembly work.

The guiding principle for long cycle-time assembly work, is that there must be conformity between the work perception on the shop floor itself, the materials display on the work station and the description of the work. This implies that in long cycle-time assembly work, the description of the product and the work needs to be based on a final assembly-oriented product structure.

The final assembly-oriented product structure used in the Volvo Uddevalla assembly plant comprised five main so-called 'final assembly functional groups'. These were simultaneously verbal and visual 'maps'. They described the product and the assembly work in a way that maintained stable relations between the description of a specific automobile and all possible individual product variants.

The distinguishable functional groups were: 0. Doors; 1. Leads for electricity, air and water; 2. Drive line; 3. Sealing and decor; and 4. Interior. This division was designed to categorize the components so that the groups of materials, both individually and in interrelation, formed contexts and were distinguishable from each other. For example, that a component was to be used in the assembly of the interior, was clear not only from a single component but also from the other components being related to a group of materials assigned a descriptive name, which also belonged to a multi-level verbal, visual and spatial assembly-oriented product structure.

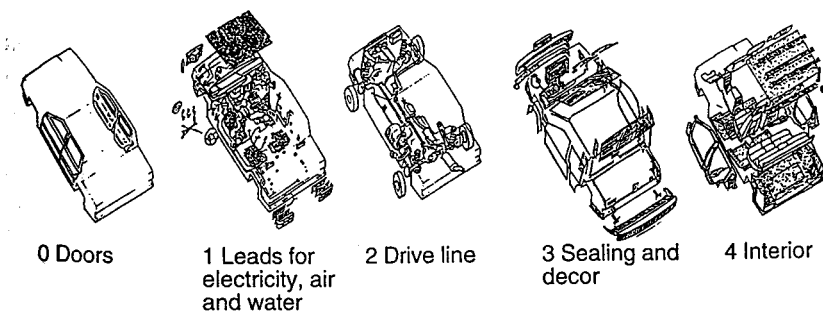
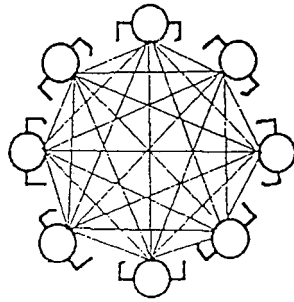
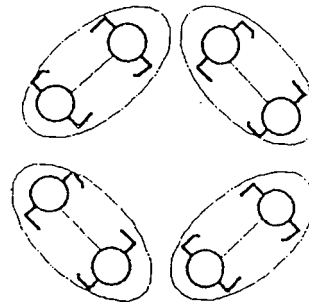

Figure 2. The final assembly-oriented product structure on an aggregated level where each distinguishable functional group corresponds to 1/4 of an assembly work on an automobile.

Although some workers in Uddevalla did assemble complete automobiles single-handedly, the most practical way was to organize the work in pairs of workers, using a cycle time of 100 minutes or more. This was dependent upon the specific competence and choice of intra-group work patterns.



Number of relationships between workers in a group of eight having complementary competence.



Number of relationships in a work group consisting of eight, all having the competence to assemble a complete product.

Figure 3. Schematization of the difference in complexity between different intra-group work patterns. The experiences from Uddevalla indicate that efficient work groups performing long cycle-time automobile assembly ought to contain five to nine operators and consist of sub-groups of two operators. These operators should be supported by one or two alternating individuals co-ordinating several subgroups, building subassemblies in close proximity and performing general services, such as checking material, cleaning, etc.

The base for the technical concept of the now defunct Volvo Uddevalla plant was the increased efficiency demonstrated as a result of parallelization and the result of the elimination of inefficiencies, as illustrated in figure 3 (Wild, 1975; Engström, Lundberg and Medbo, 1993).

According to our observations, interviews and video recordings, the assembly performance of fully run-in work groups assembling complete automobiles in Uddevalla was 14–16 percent better (equal 10–12 hours) than the time calculated by the industrial engineers, using time and motion studies. These performance results should not, however, be mixed up with or compared to Volvo's official data which reported an assembly time of 32 hours in November of 1992, since this figure refers to all blue-collar workers in the plant, including materials handling, maintenance, etc.

	<i>Serial flow</i>		<i>Parallel flow</i>	
	<i>Theoretical</i>	<i>Observed</i>	<i>Theoretical</i>	<i>Observed</i>
Balance loss (%)	5	30	1	5
Division of labour loss (%)	6	25	4	15
System loss (%)	25	80	5	20
'Work inefficiency' (%)	35	135	10	40
Total need of manpower (%)	136	236	110	140

Figure 4. Theoretical and observed inefficiencies for serial and parallel flows. The figures show that the parallel flow is obviously the most efficient one. The observed data are derived from several of our studies of Swedish automotive manufacturers, while the theoretical losses have been calculated. The losses are expressed in relation to the so-called 'necessary work' time equivalent to 100%, which is the work time required for one operator to carry out all the work under ideal conditions. The 'necessary work' needed is defined by the product design. Only the time from the point when the worker has the component in position for assembly until the component has been fitted, is included. The figures in the table above clearly show the superior performance of the parallel flow production system (140% contra 236% total need of manpower). These figures are more correct than the official assembly times published by Volvo, proclaiming the productivity of different Swedish production systems to be equal.

One design criterion behind this production system was that human capabilities and needs, as well as market demands should be the starting point for the design of technical and administrative preconditions, the common denominator being the product itself.

The parallel flow and the extended cycle time used, called for pre-structuring the information and materials needed to facilitate the assembly work. This pre-structuring demanded non-traditional materials feeding techniques. Therefore, the materials were supplied as kits in kitting fixtures containing materials for the individual product, combined with advanced information systems. The systems were contingent on a precise verbal network complementary to, for example, the part numbers traditionally used by automotive manufacturers. This means, among other things, that every component is designated a name indicating its function, assembly position on the vehicle, etc. In fact, the information system in Uddevalla even included locally defined nick-names of certain characteristic components.

The complete product constituted a whole that formed the basis for the structuring of the assembly and materials handling work. This was made possible by the product being described in detail by the design department.

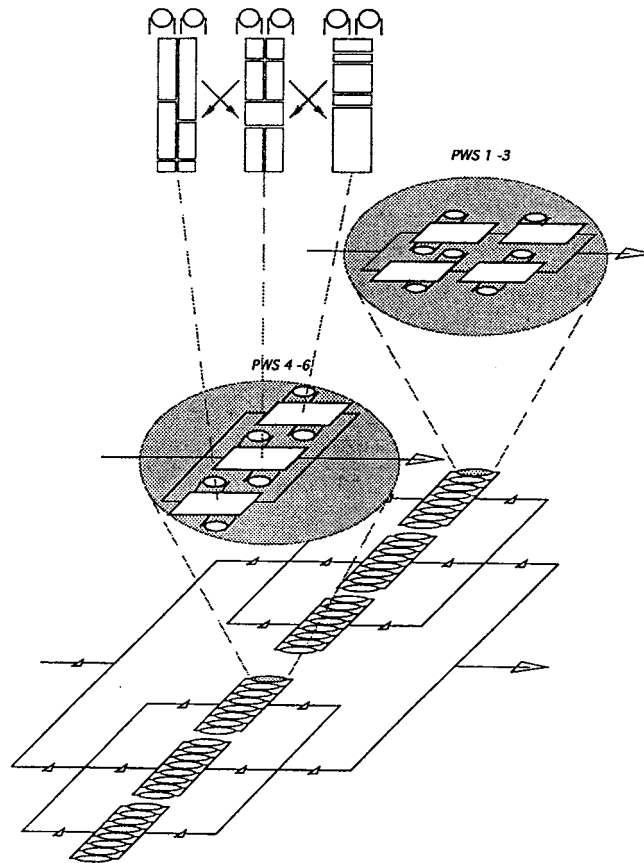

Figure 5. Schematization of the flow pattern in Volvo's final assembly plant in Uddevalla. We have illustrated the intra-group work pattern used in work shops 4–6 (the blocks in the upper part of the figure). Note that these work shops are not identical to work shops 1–3. In 4–6 the body is standing still at one internal work station during the whole assembly, while in 1–3 it is moved once. There are also other dissimilarities with regard to the location of the subassembly stations, assembly tools, etc. The labour-intensive sub-assemblies, such as doors, engine and instrument panel, were integrated into the work groups. The aim was to increase the internal assembly-active buffer, e.g., the amount of work time available but not always used. The difference in layout was due to the work shops being put into operation successively (thus avoiding the difficulty of co-ordinating and training the whole work force at the same time). The experiences gained from the work shops in operation could be applied to the design of work shops completed later.

The long cycle-time assembly work can, in itself, be said to verify the pre-structuring of information and materials performed in advance. This method ensures that the products assembled are in accordance with the product design specification, which has proved not to be the case in traditional production systems.

This type of work and information structuring is possible, through the fact that the components included in an automobile are related to each other and to the symmetries that exist or arise in the vehicle during the assembly process. The components are related to each other due to the causal connections, assembly sequence, as well as the variations in the total flora of product variants, forming long chains with a varying degree of self-explanation during the assembly. This becomes evident if one compares different product variants to each other, or if one understands the functions of the subsystems in the vehicles.

When the automobile stands still during the assembly process, as was the case in Uddevalla, these relations become obvious. Using specially designed materials feeding techniques it is, for example, possible to achieve a relationship between the components fitted and the one to be fitted. It is also possible to exploit the vehicle's organic as well as generic characteristics, thus constituting 'holistic learning' as opposed to 'atomistic learning'. In 'atomistic learning', the starting point is fragmented work tasks. In 'holistic learning', on the other hand, the individual focuses on the message or idea being communicated. Such an individual is said to have a 'holistic approach'. For example when viewing the learning aids as a whole, in which the parts are seen in relation to this whole (Marton, 1986; Marton Hounsell and Entwistle, 1986)

When a traditional assembly line is used, it is obvious that the movement of the automobile body through the plant determines the nature of the work. In the Uddevalla plant, however, the work was characterized by the intra-group work pattern. To the untrained eye, this work does not seem efficient since nothing appears to happen. On the assembly line, on the other hand, the work pace is more obvious. The nature of the design of the technical and administrative preconditions in the production systems advocated here, ought to be such that the individual and the work groups have to become increasingly skilled. Increased knowledge has to pay off in the form of extended technical and administrative autonomy, both at individual and group levels.

Such extended autonomy was not fully achieved in the Uddevalla plant. Among other things, the development of a 'bureaucratic' production planning and scheduling system was not suited to the shop floor characteristics. However, a new concept for planning and scheduling was developed before the shutdown, but not in time to be implemented.

4. The Uddevalla production principles

The inverted design process of the Volvo Uddevalla plant generated five new production principles, methods for achieving high productivity, quality, as well as, flexibility:

1. Parallel flow pattern and autonomous group work. In fact this was an organic flow pattern characterized by successively decreased mechanization, increased parallelization and maintained or expanded sorting capacity from the beginning of the process to the finished product. The work group members carried out assembly work on several products simultaneously. It seldom occurred though that more than two workers were working on the same product at a time. Thus it was possible to vary method and pace, depending on how the work proceeded. This was also independent of the work status and variation of other work groups.
2. Prestructured materials feeding to individual products. The larger components with their obvious positions in the product were brought to the place of assembly in kitting fixtures. On the kitting fixtures were also a number of plastic boxes containing medium-sized components as well as plastic bags containing small components (Johansson, 1989; Johansson and Johansson, 1990). These plastic bags contained the small components needed for every automobile. There was a large number of these small components and they represented the greatest share of the assembly time. Through this arrangement, a considerable reduction in materials-handling time was achieved. Moreover, this way of feeding materials served in itself as a learning aid and work instruction.
3. Naturally grouped assembly work. This presupposes that the traditional disintegration is broken and professional skills are created (the characteristics of a skill are: natural rhythm, holistic view, functional grouping and result orientation). The skills involve a number of tasks being combined in work functions (Nilsson, 1981; Ellegård, Engström and Nilsson, 1991). In practice, this means that the natural relationships between materials display, administrative work description and the method of working are preserved. This in turn has led to the development on the shop floor of a professional terminology and concepts which draw on the design work to a greater extent than usual.
4. A final assembly-oriented product structure. This leads to more efficient information handling, where the product and the work derive from an assembly-oriented product structure and where they are described using a number of predefined interrelated 'charts'. The naturally grouped assembly work was supported and formalized by an information system which is capable of breaking down the product into its smallest components and relating this information to the long cycle-time assembly work.

5. Materials and production control based on the principle that products that are similar for assembly purposes are also principally similar. This is so when it comes to materials handling and product descriptions including work instructions, so-called assembly variants. This meant less need for replanning and also a materials consumption sequence, which was more consistent with the planned sequence. It also led to reduced buffer volumes, better just-in-time efficiency and a reduced number of variants in the final assembly. However, as previously indicated, this type of production control was never introduced, due to the decision to close down the factory.

The application of these production principles had the following nonobvious, or initially accepted effects:

- Reduced space requirements including buffer volumes compared to traditional line assembly. This was due to few products being placed in intermediate buffers between different production phases and to reduced need for transport areas. This was the case as most automobiles in the product workshops were ‘assembly active’, i.e., subjected to assembly work. Despite the resulting space increase due to the under-utilization of operator positions around the product, more efficient work was achieved as a whole. Or put another way, if the flow is parallelized, the space is increased because the larger work stations are more than compensated for by the reduction of the buffer volumes needed for technical reasons between work groups placed in a series (Engström, 1993).
- Reduced need for expensive tools compared to traditional line assembly for several reasons: (1) the degree of mechanization was lowered on account of greater work content and less complicated tools; (2) fewer tools with a fixture function were required, as the assembly workers in the work group commanded the whole tolerance chain and were capable of fixing the component, adjusting its position and finally fitting it to the required torque; (3) expensive production equipment was utilized jointly by several work-groups, and (4) glued components were fitted using small fixtures with low pressure allowed to be applied for a longer period. This was in contrast to short cycle work and products that move from work station to work station, implying that glueing requires high pressure and a short application period.
- The efficient information handling led to a speeding up of the time and resources needed to implement a change of model and to effect change orders. In this respect, the Uddevalla plant also proved superior to Volvo’s other automobile plants.
- Successively reduced need for technical production support (production engineering and supervisory functions) to the work groups.

- Flexible work scheduling, which led to shorter lead-times than in traditional production systems. It has in practice only become possible to manufacture automobiles which have already been sold to the customer.
- The difficult, time-consuming or complex product variants could be manufactured at the same time as more common variants, without generating disturbances in the production system. It was possible to start building certain product variants, try-outs, as the introduction of new variants did not require extensive work by the worker or the industrial engineers.

5. Conclusion

Finally, we conclude with one important fact concerning the Volvo Uddevalla plant, namely, that the unique production principles used led to superior performance due to reduced inefficiencies. This has confirmed the relevance and validity of the theoretical and empirical frames of reference, as well as of the extensive research and development background only touched upon in this article. The technical dimension formed the vital preconditions for advanced work organization on the shop floor, as well as for flexible manufacturing, including the organization of white-collar work. This potential was unfortunately not fully realized during the plant's short lifespan.

References

- Argote L., Epple D. (1990). 'Learning Curves in Manufacturing'. *Science*, Vol. 247, pp. 920–924.
- Blackler F. H. M., Brown C. A. (1978). *Studies in British Leyland and Volvo*. Saxon House Westmead, Farnborough.
- Ellegård K., Engström T., Nilsson L. (1991). *Principles and Realities in the Reform of Industrial Work – the planning of Volvo's car assembly plant in Uddevalla*. The Swedish Work Environment Fund. Stockholm.
- Engström T. (1993). 'Reorganisation of Material Flow for Naturally Grouped Assembly Work – some principles and results from action research'. *International Journal of Technology Management*, Vol. 8, No 5/6, pp. 384–395.
- Engström T., Karlsson U. (1982a). 'Alternativ montering'. Institute for Management of Innovation and Technology. Chalmers Tekniska Högskola. Göteborg (in Swedish).
- Engström T., (1983). *Materialflödessystem och serieproduktion*. Institutionen för Transportteknik. Chalmers Tekniska Högskola. Göteborg (doctoral thesis in Swedish).
- Engström T., Lundberg A., Medbo L. (1993). 'Evaluation Methods for Assembly Work and Product Design in Radically Different Production Systems: Results from case studies and action research in Swedish industry'. *Productivity & Quality Management Frontiers – IV*. Industrial Engineering and Management Press, Norcross, Georgia, pp. 333–342.
- Granath J.-Å. (1991). *Architecture, Technology and Human Factors – Design in a Socio-Technical Context*. Department of Industrial Architecture and Planning. Chalmers University of Technology (doctoral thesis).
- Johansson M. I. (1989). *Product Design and Materials Handling in Mixed-model Assembly*. Department of Transportation and Logistics. Chalmers University of Technology. Gothenburg (doctoral thesis).
- Johansson M. I., Johansson B. (1990). 'High Automated Kitting System for Small Parts – a Case Study from the Volvo Uddevalla Plant'. International Symposium on Automotive Technology & Automation. Vienna. Proceedings, Vol 1, pp. 75–82.
- Karlsson U. (1979). *Alternativa produktionssystem till linjeproduktion*. Sociologiska Institutionen, Göteborgs Universitet. Göteborg (doctoral thesis in Swedish).
- Marton F. (1986). *Fackdidaktik*. Studentlitteratur. Lund.
- Marton F., Hounsell D., Entwistle M. (1986B). *Hur vi lär*. Rabén & Sjögren, Stockholm (in Swedish).
- Nilsson L. (1981). *Yrkesutbildning i nutidshistoriskt perspektiv*. Acta Universitatis Gothenburgensis. Göteborg (doctoral thesis in Swedish).
- Rosengren L.-G. (1981). Potential Performance of Dock Versus Line. *International Journal Production Research*, Vol. 19, No. 2, pp. 139–152.
- Wild R. (1975). On the Selection of Mass Production Systems. *International Journal Production Research*, Vol. 13, No. 5, pp. 443–461.
- Wright T. P. (1936). Factors Affecting the Cost of Airplanes. *Journal of Aeronaut Science*, Vol. 3, pp. 122–128.

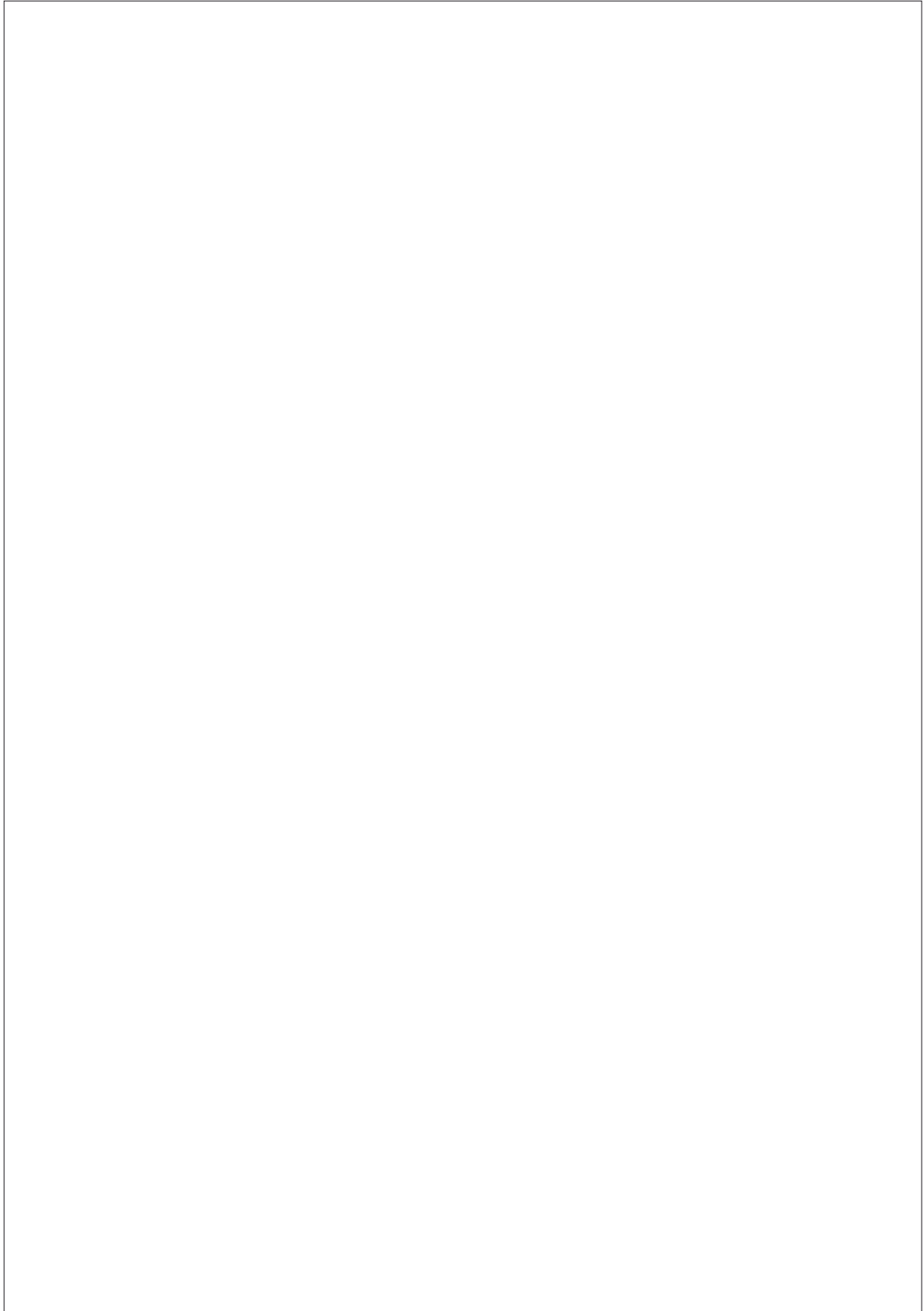

The Uddevalla plant:

Why did it succeed with a holistic approach
and why did it come to an end?

Lennart Nilsson

This paper will ask and answer the question: how did Volvo succeed in developing a new concept for production and learning at its Uddevalla plant?

The answer lies in the unique combination and arrangement of the following factors:

- a) The ways in which the materials (components) were handled through a new and unique grouping strategy.
- b) The replacement of line-assembly by parallellized work places, where the assembly work is carried out by a few people at each work place.
- c) The arrangement of the assembly work in accordance with new organic and holistic descriptions within learning strategies which support the integration of physical (manual) and mental capabilities needed to carry out the total assembly work.

The story of Volvo's Uddevalla plant is a story of how it was, and still is possible to create a realistic alternative to main-stream industrial work, not only for the automobile industry, but also for working life at large.

Let me explain, as one of those who provided input into the renewal of work with car assembly. As stated above, points a and c are the results of research on human learning, particularly within vocational learning (Nilsson, 1992c), while point b refers to how materials and working processes are carried out. With these three points in mind, we have developed strategies for organic and holistic descriptions (Engström & Nilsson, 1992).

A basic presentation will be made in this paper. For further discussions regarding point b and the reasons behind the change from line-assembly systems to parallellized work stations and the efficiency of this system see Engström, 1992a and 1992b.

The beginning

The Volvo Uddevalla plant was expected to be innovative in that it would make car production more efficient and at the same time provide human conditions for industrial workers. The primary objective of the project management, one which was supported by Volvo general management, was that the technical equipment should be adjusted to the workers and their growing capabilities (skills).

It was also agreed that Uddevalla should be a work place for women and men of varying ages, as a mixed workforce should be viewed as an asset. New learning and technical strategies should be developed. This was the standpoint in 1985 when the story began.

However, nobody at Volvo could answer the question of how to bring about this innovation. The management therefore sought external help from scientists who had knowledge of practical applications. It is a long standing practice of Volvo to seek external help in order to innovate.

The Volvo board and the project group for the Uddevalla plant considered the experiences of the Volvo Kalmar plant as a model to develop from. But this view gradually became problematic as the new Uddevalla plant became qualitatively different from the Kalmar plant.

As an external consultant, I was asked how long can a time-cycle be for the workers? I had as a researcher and teacher in the field of vocational learning for 20 years, never been asked such a question as the main issue of concern. Why this type of question? Gradually I realized that this question was the key to understanding the way of thinking of most people at the new plant. The starting point for them was time and not content.

The question I was asked could not possibly be answered because the answer depends on what people do. I suggested that they view the problem differently, in terms of content and context, and I also understood that the way of thinking of many people in the planning group was a reflection of the thinking in traditional assembly-line production.

The Kalmar plant assembly work at that time consisted of just an addition of five to seven minute short-time cycles from standard line production. This addition resulted in a work cycle of 20 to 30 minutes. Now the Volvo people were considering the possibility of adding some other small pieces of work in order to create a longer work cycle.

What they didn't understand at that time was that in doing so they restricted themselves to an additive and reductionist way of thinking. Although this approach is also valid, it is not conducive to the creation of something new and more efficient than the existing systems. There are alternative approaches and I suggested another way to think and act from a holistic model which focuses on content and the context from the workers' point of view. In my opinion, the change from time to content as the focus for renewal

of assembly and material handling work is the most important qualitative change needed for innovation.

As a result some people changed their minds while others returned to the Torslanda traditional plant. Many people behaved as mental prisoners of the line-system. This was a reality that later created a lot of problems for the Volvo Uddevalla plant.

However, some leaders of the planning group wanted to create what they called 'natural work', as a contrast to the traditional conditions related to line-production. They had difficulties in expressing what they meant by this term, as it was really an umbrella term for all those who wanted a change from line-production.

Because of this ambiguity I was asked to explain the meaning of this term, 'natural work', and to define criteria for the kind of activities such work may comprise. 'Natural work' I characterised (Nilsson, 1985) as the following:

1. The worker is in control of the work performed during the day, and usually, over longer periods of time.
2. The work in its entirety should be surveyable.
3. The work is meaningful from the workers' point of view and is not predetermined by time factors.
4. The transfer of knowledge takes place principally from one worker-generation to the next generation within the profession.

The main point here is that the work content and qualities are superior to the administrative division of working time into small pieces, which is the way assembly work has been carried out during the last 70 years.

This fundamental view in natural work, as I have defined it, made it possible to deal with the content in assembly work from a qualitatively new approach, an organic and holistic approach. This approach differs from the mechanistic additive approach and its applications of scientific management. This change of orientation to support 'natural work' had a great impact on renewal. It has become possible and interesting to talk about what supports human learning. Gradually during the spring of 1986, a strategy for learning that supports the human being in mastering the complexity of materials handling and assembly work, was developed in the planning group with my help as an external consultant.

The strategy can be summarised by the following six points:

1. Learning must be established in work with real products, for example on cars produced for the market place.
2. Learning must be organised to allow the product and work processes to be surveyed by the learner/worker.
3. Learning must comprise the work in its entirety or at least functional wholes of the work content.

4. Administrative division of working time should be replaced by an organically functional work content.
5. Vocational competence in terms of knowledge and skills must be transferred from the professionally skilled to trainees.
6. The learning process should include tempo training with maintained quality of work performance.

The total car assembly process was the starting point of the learning process. The car was the means. But the means also resulted in a real product produced for the market. By using the product as a tool in the learning process it was possible to avoid the otherwise customary division of learning into small, additive, and defined steps. Now the learner could see the meaning of his learning and was able to survey his work.

Using the results of the organic and holistic descriptions of the assembly process and the materials handling, it became possible to implement a generative and organic approach to learning. This approach and the descriptions of the car as an organic structure enabled creating the competence needed to master the great number of components and tools that were used in combination with different demands on precision within the assembly work.

Learning must comprise the work in its entirety and the learner and the worker must be able to survey the work, as well as to have autonomous control over the process and tools with which to assess quality. The holistic view and its corresponding demands means that different emotional, manual, and intellectual demands will be placed both on the individual and on the groups of people working together. The learning process must, therefore, be oriented towards the development of the individual's competence, as well as towards optimal co-operation within the teams. It is the collective results of the team that are crucial to the attainment of the desired production quality and productivity (here and below used as a measure of the output per time unit)

In the learning of the 'enlarged' assembly process the car (i.e., the body and its components) is always the means as well as the result, or end, of the process; but it is not the goal. That is, it is the competence that is the goal. The competence will be used to attain the desired quality and productivity.

To create the competence needed to master long-cycle work, such as expanded assembly work, it is necessary to develop an 'inner monologue'. This inner monologue should co-ordinate the relationship between 'the work of the hand' and 'the work of the mind'. The aim in developing an inner monologue is to link these processes at the individual level, as it refers to a mental orientation in the form of self-reflection and thoughts in relation to aspects of work, both before and during the actual work. This is a fundamental point in the development of learning strategies for the creation of a vocational identity.

In order to encourage the development of inner monologues, as an external

consultant I had to formulate questions in relation to the different phases of the expanded assembly work. The character of these questions are, from a learning point of view, an important determining factor for the kinds of knowledge the trainee will acquire.

Vocational identity for the growing group of car builders includes: The ability to relate ones' own knowledge and experience to questions relating to materials (components and structuring of the work), choice of tools, demands on precision, work patterns as well as general assembly skills and ergonomic aspects of work, and also how to inspect the work and make adjustments. By following these steps a new profession was developed.

The questions were also part of the mutual relations between those learning and those in a 'teaching' position during the learning process. Obviously the expanded assembly work places different qualitative demands both on the individual and on the working teams than is the case for short-cycle work.

By making use of all aspects of human capabilities – emotional, motivational, manual, and intellectual – it is possible to break away from the traditional division between manual and intellectual tasks and between 'blue' and 'white' collar tasks. This also means a change of power and control of production, as well as of the inner functioning of the plant and the company.

The development of an inner monologue is a primary factor in the creation of a vocational identity in the centuries – old Western European handicraft tradition, which is also applicable in the 'New World' in the aftermath of the Taylorist phase of the industrial era (Nilsson, 1992a and b).

The new organic and holistic perspective for materials handling and assembly work

An organic and holistic viewpoint perceives the variations between different aspects and things in the world as an asset. In the case of materials handling and assembly work this means that one makes use of the variation between components, in terms of size, shape, colour, weight, and fragility, as important factors for the creation of memory images and for discrimination in order to organise groups. Any kind of grouping is made for a specific purpose; in this case, the purpose is to facilitate the mastering of the complex tasks resulting from the use of many different components.

In order to reduce the complexity produced by the amount of components involved, the existing mechanistic way of dealing with this problem has been to replace the natural variations by codes suited to computer systems, but not to the unique capabilities of human beings. Herein lies the problem. Choosing the components is not in itself difficult, nor is the assembly work in terms of knowledge, materials, and structuring of the assembly. What is

Model of the different phases in the expanded assembly work				
Knowledge of materials	Structuring	Assembly	Inspection	Adjustment/inspection (action)
<p>Questions such as:</p> <p>Which components are to be found in the assembly zone?</p> <p>How are the components fixed?</p> <p>Are the components the correct ones?</p> <p>What quality demand are there on this component?</p>	<p>Questions such as:</p> <p>In which function are the components included?</p> <p>How is this information about the assembly obtained through documents?</p> <p>What tools are to be used?</p> <p>What demands on precision are there for assembly/fit?</p> <p>How should the work pattern look as regards assembly work?</p>	<p>Questions such as:</p> <p>How should the work patterns look as regards relations between individual/-s - tools, - components, - car body?</p> <p>How can variation be achieved in movements to prevent injury to people and damage to materials and tools and attain desired quality and work intensity?</p> <p>Performing assembly tasks.</p> <p>How should worker-inspection be carried out during and after the work process?</p>	<p>Questions such as:</p> <p>How should the completed assembly look when it has been correctly carried out?</p> <p>What instruments are used to determine whether the work has been correctly carried out?</p> <p>What routines are to be followed if defects are detected?</p> <p>How is the completed inspection documented?</p>	<p>Questions such as:</p> <p>How are the various types of defect rectified?</p> <p>How are the rectified defects and desired quality attainment checked?</p> <p>How are the rectifications and new inspections and new inspection documented?</p> <p>How are results reported, and to whom, to prevent recurrence of defects?</p>

Figure 1. Model of the different phases in the expanded assembly work.
Source: Nilsson 1994:c, p. 40

difficult is the use of mechanistic descriptions not related to the ways human beings create orientation, groupings, context-relations, and survey the work. All this can be looked at as 'tools' human beings use to master complexity and achieve a professional identity.

The objective is to create descriptions which facilitate for human beings to work by means of a natural mental approach, perceiving components as meaningful wholes from the viewpoint of assembly and the workers' own apprehensions and/or experiences. This was the challenge that was taken on by researchers from two scientific disciplines, engineering and vocational learning, and gradually also with active contributions from workers at the Volvo Uddevalla plant with support from the management. The way we worked together was very successful and made it possible to create new ways of handling materials from 'input' to the completed car. Our co-operation also created new ways of describing the assembly and new guidelines for the assembly work itself.

In this context it is important to remember that when the Volvo Uddevalla plant was set up nobody had any knowledge of how to organize the flow of materials so as to suit an assembly process in which the car (body) remained in the same position (the work place) throughout the assembly process.

The way that was chosen was to group the materials according to assembly function relationships, meaning that components belonging together in relation to assembly were arranged into groups by their characteristics, such as size, weight, shape, colour, and fragility. The components belonging to one assembly functional group ('family') were also related to a main assembly functional group ('kin'). This made it possible to view the cars as they passed along the assembly process from the material grouping to the finished assembled car. In this way the process could be viewed as an organic process instead of as a mechanistic addition of parts.

Descriptions which take into account the natural variations in colour, shape, size, fragility and relate them to the components' names, 'families', and 'kin', as well as to surveyable patterns and contexts, vitalize the mental, emotional and physical life of the assembly workers. The mechanistic, descriptive, primarily numerical orientation which dominates car assembly work limits the opportunities to enhance the competence of the workers and is an impediment for the development of professional learning. In this context it is also important to realize that the mechanistic description has other purposes than the organic, holistic description.

The mechanistic description is organized so as to view the product from within the existing work organisation. It is also possible to apply it from a sales perspective. With such a perspective the final result, the car, can be viewed as the total sum of all component parts and the 'whole' is reduced to a numerical code.

But from the workers' point of view the mechanistic description is impossible to work with. When one works in long cycles of 1.5 hours or more and one is developing a professional identity, the work content is large and entails correspondingly many responsibilities. Furthermore it is necessary to be able to survey the total work and to obtain support in terms of a description of the context in the space and time orientation.

It is also necessary to have access to descriptions that make it possible to obtain information on different precision levels. This last point is extremely important both during the learning process and as a reference in the long term in order to support quality and productivity.

The main point here is that the mechanistic descriptions had too limited applications. But the organic and holistic descriptions have the possibility of being used both as a tool for assembly work, materials handling, construction, and for sales; in short, a multidimensional usefulness.

Without grouping materials in relation to the car it would not have been possible to create an alternative to line assembly or to create parallellized workplaces. The materials were now related to 'the body'. The body remains stationary during the assembly work. This technical innovation was made possible thanks to the new description. All this work was carried out by Tomas Engström and co-workers. Gradually the system was adjusted by the experiences of the Volvo Uddevalla plant with assistance from the workers and technicians at the plant. A lot of the new description was naturally used in the integrated learning and development processes at the plant.

Some notes on the processes of creating competence

It is possible to distinguish three different phases during this period of about six years:

The first phase was very constructive. The work content was at the same time approximately one quarter of the total assembly time of the car. After a certain time period the worker would continue to the next quarter stage of assembly work, and so on, in order to obtain a good understanding of the total assembly process. Following this, the worker would choose which of the four stages to become more professional and specialized in, in terms of quality and productivity.

The main point here is that the learning content was greater than the work content after learning. This strategy ensured co-operation between the different phases of the production of the car.

External consultants (Engström and Nilsson) helped the workers to create illustrations, to group materials and tools and to implement general learning strategies. All efforts were organised so as to support a holistic view of the work and the competence to master a greater part of the total work.

Those who had learned the techniques became 'instructors' for novice workers. This was much like the comprehensive training of the old apprentice-journeymen relationship in the guild system. However, nobody spent the entire working day in the teaching position. The short time between being in the learning position and in the teaching position made it possible to remember what was important from the learners' point of view. It created a willingness to explain how to do the assembly work and why. We then worked on improving the 'inner monologue' as a tool for creating a professional identity.

During the first phase the workers' competence increased dramatically as realistic plans were carried out for future developments. This phase was the most successful I have seen during twenty years as a researcher and teacher in the vocational field. During this phase the learning followed the strategy developed during the spring of 1986.

The second phase began with an additive view of learning and assembly work. Technicians from the Volvo Torslanda plant took control over production and learning. They created an administrative division between parts of the assembly work. The total assembly work was looked upon as consisting of seven to nine parts. Every person who worked with assembly had to learn his or her part. As a consequence very few had the competence to help other workers due to a lack of competence outside their own working area. Many of the problems previously encountered in line production reappeared.

The competence achieved during this period by the new recruits did not reach the level achieved by those who had come during the first phase. Nor did the production of the cars reach the expected level. This was not due to a failure of the learning strategies for the plant. It was a consequence of the fact that the people who had the power over production and learning at that time did not use the strategies created to build competencies.

All the resulting problems which occurred during this phase were predicted by the external consultant, but those in power were not interested in listening and acting in order to reduce the problems needed to reach the efficiency of the new production and learning concepts.

During this phase another extremely important event occurred. At this time the discussion at Volvo was whether the traditional Volvo Torslanda plant should be reorganised in the direction of the Uddevalla plant or if it should be organised in relation to lean production and become something like a 'Toyota-city'. The problems at the Uddevalla plant contributed to the fact that few wanted to create an 'Uddevalla model' at Torslanda.

The actions from those in power over production and learning at the Uddevalla plant during this phase contributed to the dissolution of the plant some years later. After some time many of them left for the Torslanda plant.

During the third phase which was to become the last, a very constructive renewal of learning and organisation of production was started. Now the new management tried to return to the original learning concept and to minimize the negative effects of the previous administrative division.

The quality and the productivity increased to a very good level. For the last 1.5 years the amount of hours required for the production of cars decreased. A very constructive situation existed in the autumn of 1992 when Volvo decided to close the plant.

There had been a dramatic increase in the efficiency at the Uddevalla plant during the spring of 1992, until the decision to close reached the plant. This efficiency had possibly been achieved 2–3 years earlier if those in charge at the time had followed the strategies developed to create competences for long-cycle assembly work.

The main feature of the new production and learning concept is thus that workers have the competence and responsibility over a rather large part of the assembly process of the car.

All the criteria that one had expected the plant to meet were fulfilled:

1. The efficiency in car production was very good regarding work quality, productivity and flexibility.
2. It had achieved dignity in terms of professional identity and human conditions for its workers.
3. The technical equipment had been adjusted to the workers and their growing competence.
4. It was a working place for both men and women of varying ages.
5. It had a very low rate of absenteeism and turnover.
6. New learning strategies to support long-cycle assembly work, new organic and holistic descriptions for materials handling and assembly work as well as, new technical strategies for parallellized work places had been developed.

However, the total capacity of the concept was never realised at the Uddevalla plant. For example, the plant did not work in close relation to the consumer which would have reduced the total costs and created qualitatively new relations to the market.

The arguments from Volvo for closing the Uddevalla plant

The closing of the Uddevalla plant is officially based on two arguments. The first is based on the argument that the three different plants for assembly work in Sweden, Torslanda, Uddevalla and Kalmar, were seen as equal in terms of efficiency. This is untrue.

The second argument was that the costs of production at the Uddevalla plant was seen as much higher than the costs at the Torslands plant. This is also untrue. The official economic description is not correct. Both these publicly made arguments for closing the Uddevalla plant are based on false assumptions.

Volvo opted to close the two new and future oriented plants. The closure of Uddevalla (spring 1993) and Kalmar (spring 1994) took place during a very unstable economic period for both Volvo and Sweden.

Volvo opted to continue with the old and big Torslanda plant in order to create a plant with centralised complete production. The decreased sales of cars supported the reasons to close the other plants. The alternative was to drastically decrease the production of cars during this period, while preserving the plants.

If the lack of competence among some of the leaders at the Uddevalla plant had not been allowed to influence the production and learning processes during a certain time, the Uddevalla concept would have displayed its multifactored strength at an earlier time. Most probably, as a result of this, it would have won over the stepwise change of traditionalism from Taylor via Ford and MTM to large-scale industrial plants with a lean-production orientation. This is the tragedy of the Swedish Volvo plants.

The concepts for production and learning developed as a consequence of the intentions of the Uddevalla plant, by the researchers involved in the work called 'reflective production' has survived and will become a model for working life in the future. Unfortunately the Volvo Uddevalla plant in its tragic premature closure will not be able to demonstrate the success of this model.

References

- Ellegård, K, Engström, T. and Nilsson, L. (1992), *Reforming Industrial work – principles and realities*, The Swedish Work Environment Fund, Stockholm.
- Ellegård, K. et al., (1992) *Reflektiv produktion – industriell verksamhet i förändring*, AB Volvo Media, Förlagsgruppen, Göteborg.
- Engström, T. (1992a), 'The reorganization of the technical and administrative conditions for assembly work' in Ellegård, K, Engström, T and Nilsson, L (1992).
- (1992b), 'Effektivitetsproblem i den storindustriella modellens fabriker' ('Efficiency problems in the factories of the large-scale industry model') in Ellegård et al. (1992).
- Engström, T. and Nilsson, L. (1992), 'The encounter between holistic learning principles and the reorganization of materials handling and assembly work' in Ellegård, Engström and Nilsson (1992).
- Nilsson, L. (1985), *Naturligt arbete och industriellt lärande* (Natural work and industrial learning). Paper at the Göteborg University, Dept. of Education and Educational Learning.
- (1986), *Utbildningsstrategi för blivande bilbyggare* (A strategy for learning in order to create car building competence), Paper at the Göteborg University, Dept. of Education and Educational Learning.
- (1992a), 'Förändring av lärandet' ('Change of learning') in Ellegård et al. (1992).
- (1992b), 'Lärandeprinciper som främjar långcykliskt arbete' ('Principles for learning in order to support long-cycle work') in Ellegård et al. (1992)
- (1992c), 'The form and orientation of learning' in Ellegård, Engström and Nilsson(1992).

Volvo Kalmar – twice a pioneer

Thomas Sandberg

In 1974, Volvo's new Kalmar plant became the first assembly plant in the world to break with the Fordist concept. With a new work organization and production layout, which attracted tremendous international attention, Kalmar in a few years became Volvo's best assembly plant. Yet there were many built-in weaknesses in the Kalmar concept.

Towards the end of the 1980s several processes of change began, which promoted even further development of the original concept. In turn, as well as this led to dramatic economy improvements as well as in terms of working conditions. Once again, Kalmar in many aspects became Volvo's best assembly plant. In spite of this, and although its production was needed, Volvo closed down the Kalmar plant in 1994.

1. The original Kalmar concept

1.1 The breakthrough of a new work organization and production layout

Behind the design of the new plant was the ambition to avoid the troubles, that beset the Torslanda plant in Gothenburg, by improving working conditions and thus reducing absenteeism and employee turnover. Instead of taking job fragmentation and predetermination even further, the organization strategy in Kalmar aimed at independent assembly teams, each assembling a (functional) part of the car. The work content was 15–40 minutes long both along the line, where assemblers followed the car between various stations, and in the docks, which were a kind of side track (cf Agurén et al, 1976; Agurén et al, 1984; Berggren, 1993a, pp 119–29; Sandberg, 1982, ch 11 for further information on the original Kalmar concept).

To achieve this, a substantial renewal of the production strategy was required. The clover-shaped, two-levelled building contributed in creating

'the small factory within the big' in as much as each department had its own, relatively separate area with its own entrance and personnel space. As a replacement for the assembly line an autocarrier was developed, i.e. an individually moving, centrally controlled low platform following magnetic tracks in the floor throughout the factory. Between the departments were buffers in order to create a certain independence. The autocarrier was not only a means of transport, but also the platform on which the assemblers did their job. In that way they could begin assembling ahead of a station or in the incoming buffer, thereby gaining a time buffer and increasing their autonomy. In some departments assembly was done in docks, which made it possible to move the car from the line and assemble on stationary objects.

During the 1960s Torslanda was increasingly manned with employees who held a weak position on the labour market. The localization of a new plant in Kalmar can be seen as a continuation of that personnel strategy. The Kalmar area is a region with a relatively weak labour market, making it a bit of a green site. At the same time, the aim to improve work content to achieve a greater work satisfaction meant a modification of the purely instrumental relation between employees and company.

The Kalmar plant did not imply any new orientation concerning the business strategy, e.g. regarding product programs or customer relations. The new plant was simply a capacity enhancement.

1.2 Structures and actors behind the new concept

With the new assembly plant, Volvo appeared internationally as a pioneer, and not only within the automobile industry. Compared to other Swedish companies, however, Volvo Kalmar did not emerge very early. Saab's new engine plant in Södertälje, which began in 1972, also overturned traditional organization and production strategies. In other areas of industry there were many companies which began reorientation as early as the late 1960s. Around 1970 these experiments grew to many hundreds, not only in the industrial but also in the public and service sector (cf Sandberg, 1982, chs 9–11 for further information on the Swedish situation).

The background of the extensive attempts in work organization were the increasingly serious problems facing companies during the 1960s as a result of the rapid rationalization, carrying job fragmentation and predetermination to its extreme. The economic consequences of the production problems became manifested in balance and system losses, long lead times, high capital investment, and insufficient flexibility. It also became evident in work force behaviour as the traditional groups of industrial workers no longer accepted the increasingly monotonous wear-out jobs and, thanks to the welfare development and the decreasing unemployment, received other alternatives. Companies then started to employ new groups. The female employment rate

increased, regional migration expanded and labour immigration increased drastically in the 1960s.

At Volvo, the situation was even worse. Work studies were intense, a new version of MTM was brought forward. The new Torslanda plant, initially used in 1964, was at the height of this development. Five years later, personnel problems in Gothenburg were so serious that manning the plant was difficult. There were departments without any Swedish employee. Nor were there any remaining Finnish immigrants. The danger of the situation was underlined by a number of wildcat strikes in 1969–71. Few other companies had such serious personnel problems. The fact that the management in view of all this did not rebuild Torslanda indicates how dominating the Fordist concept was.

Despite the experiments in other companies, growing research and an intensive public debate, it was far from obvious that the new plant in Kalmar was to differ from all other plants. The first project plan was rather conventional. Progress was made only after Volvo's new president P G Gyllenhammar in 1971 replaced the project group and gave the project work a new direction. He played a central role in the emergence of the Kalmar concept by being a connection between, on one hand, insights about the problems of industrial production and their possible solutions, and on the other hand, the resources and competence that existed at Volvo.

His starting point was the necessity of being able to offer people decent working conditions: 'Thus, in order to satisfy justified demands for work satisfaction, production technology and work organization need to be changed without impeding economic growth.' The 'most important change(was) a shift from individual, monotonous work to work in a group.' As the perhaps most critical factor he considered a replacement for the assembly line (Gyllenhammar, 1973, pp 102–3,106; cf also Gyllenhammar, 1977).

A first evaluation of the Kalmar plant in 1976 showed that production efficiency was in line with Torslanda and that many of the intended improvements of working conditions had been reached. Another evaluation from 1984 showed clear improvements in assembly time per car (which now was 25% lower than Torslanda), level of quality, efficiency, and assembly costs. At the same time working conditions had changed in various ways, e.g. work intensity had increased, and some ergonomic problems had been adjusted (Agurén et al, 1976; Agurén et al, 1984).

2. An unused potential in the original Kalmar concept

In the beginning, Kalmar was met by huge expectations, which were to a large extent redeemed. However, the limitations and contradictions in the

organization and production strategies prevented full use of the potential of the original concept.

Production layout has been singled out as a key factor. To increase the assemblers' work content and autonomy some of the assembly was done in the docks next to the line. Since the carriers remained tied to a serial flow controlled by a central computer, with demand for a strict sequential order, dock assembly did not give assemblers or the working team the desired autonomy. The comparatively long work cycle in the dock also made it difficult to know whether you were on schedule when the carrier would start moving and thus the work had to be finished. The increasingly complex material supply, caused by the growing number of variants, also made use of the docks difficult. After subsequent restrictions the docks were abolished in 1984 (to reenter the scene some years later).

Another vital part was the individually moving carriers. However, their flexibility compared to an assembly line, for several reasons, could not be made full use of. They were indeed individually controllable, but control was central, a circumstance which furthermore was augmented during the first years. As a result the buffers between team areas never functioned as intended. This was further strengthened by the construction of the buffers, which made it difficult to correct the sequence between carriers which had shifted positions within a team area.

Thus, different parts of the production strategy limited the autonomy of assemblers and work teams. But the organization strategy also had features limiting the possibilities of assemblers and work teams to independently plan, carry out, and evaluate their work. The assembly task in itself had a substantially larger content than at a traditional assembly line, but in other aspects work organization of the Kalmar plant was rather conventional. In each work team there were several indirect positions, where no job rotation between group members took place. The hierarchy within the work team corresponded to the situation in the factory as a whole, since managers only to a small extent delegated responsibility and authority.

The latter also led to changes being initiated and pursued from the top, usually with lack of commitment and interest. Thus, until the second half of the 1980s, no further development of the original Kalmar concept took place. On the contrary, some of the original ideas, which had proven not to work well, were abolished. The changes that took place were traditional cost rationalizations, limited measures mainly focused on production technology. Yet the Kalmar plant performed well. In the 1984 evaluation of the first ten years was stated that 'the Volvo Kalmar plant is a technically, socially, and economically effective production unit.' (Agurén et al, 1984, p 13)

3. After 15 years a radical renewal of the Kalmar concept began

Even though the Kalmar plant in the mid-80s was successful, there were several challenges, first internal and later external. When these challenges were faced, rather fumbling at first but gradually more and more systematic, much of the weaknesses in the original concept were overcome in a series of developmental steps. We shall examine this development briefly and proceed to study it in greater detail in three parts of the plant. The section is based on field studies in Kalmar 1993/94.

3.1 Many processes of change in the last years

Changes in the product line and production volume naturally took place during what was to become the last years of the Kalmar plant. Worth noting is the shift to the 760 model in 1987 and on to the 960 model in 1990, two steps towards an increasingly qualified product and, greater work and material content. Also remarkable is the introduction of the 940 model in the fall of 1992, which reached world class quality half a year later.

More interesting in this context are the projects which gradually joined in one single powerful process, focused on developing the production process: in the early 1988 team area development was initiated, towards the end of 1989 Dialogue followed, and in 1991 came KLE.

When team area development started in 1988 the work force had grown during a couple of years while at the same time the labour market was becoming more and more overheated. To the Kalmar plant this meant a significant rise in absenteeism and employee turnover. The Kalmar concept proved inadequate to handle the personnel problems. The main focus for the team area development was to enrich the assemblers' work content with many of the side tasks which constituted separate positions: materials handling, control and adjustment, instruction, some tasks concerning production engineering, as well as, some maintenance work. As a first step three team areas participated in the project, but other areas also carried out part of it.

During 1989 team area development transformed into the Dialogue project, which was announced in the Volvo Group in 1985 but not applied in Kalmar. The purpose was to increase employee involvement and commitment in work. Attitude surveys, to get opinions on what had to be tackled, was one tool. At first not much happened, and decision-making was once again centralized in connection with the problems caused by the introduction to the 960 model. In 1991 development was accelerated, no doubt influenced by the increasingly critical situation of Volvo Car Corporation. A new strategy for Volvo's Swedish car production was formulated, and a committee was appointed to analyse plant structure (that committee in the

fall of 1992 suggested the closing down of Kalmar and Uddevalla). The principal goal of the new strategy was that the three Swedish assembly units in the summer of 1993 were to be on the peak in Europe, thus matching the Volvo assembly plant in Gent, Belgium.

From 1991 the Dialogue project, under the name of process development, came to be a new and very powerful way to promote change. The aim was to free, focus and sustain the commitment of all co-workers, in order to continuously be able to improve and expand operation towards customer-oriented goals of strategic importance. The basis was trust and faith in the capability and will of the assembly workers to assume responsibility for developing their part of the operation. The organization was flattened and a substantial delegation of authority took place. Operation was divided into 80 groups, 2–3 in each team area. The groups each with its own measurable goals, prepared operational plans which were then carried out and followed up. In the most active team area 60 changes were made in a year; in the plant as a whole the number was 900. This process of change engaged the personnel at large and resulted in a great number of modifications which developed the operation from an economic as well as human standpoint.

The undertaking of changes were aimed at improving the process, or the flow. This way of proceeding, directed at the flow, was well in line with the customer-oriented strategy which Volvo's Swedish car producers adhered to since 1991 when the KLE quality strategy (Quality, Delivery precision, Economy) was launched. The focus on quality, i.e., a spirit of 'doing it right the first time', resulted in dramatic improvements in quality and largely as a consequence of this, in delivery precision ('create flexible systems free from interference') and economy ('a complete overhaul of the structure and resources of the production system').

Through a number of circumstances these projects reinforced each other in a positive circle, while at the same time they benefited from and contributed to the basic idea of Kalmar: independent work teams with committed and skilled assemblers. The new customer- and quality-focused business strategy required the kind of organization strategy employed at Kalmar, also strengthening it through its demand for responsibility and competence in individual work. The same was true for the new way of undertaking changes. Furthermore, the new business strategy focused the change process in a direction which turned out to be a winner: quality. This fruitful interchange between business, organization, and change strategy in turn made possible a thorough development of the production strategy.

In the following sections we will examine the changes in three team areas since 1987. To a large extent, the changes are part of the processes just mentioned, but there are other factors behind them as well.

Before that, however, it should be stated that all these changes in the Kalmar plant together resulted in large economic improvements. In the beginning of 1993, the company reported that in about two years quality had improved by 40%, lead time by 25%, and assembly time by 30%. The chapter by Christian Berggren mainly considers Uddevalla but also states that Kalmar was the most competitive plant. In his more detailed report (Berggren, 1993b) not only the good results concerning assembly time and quality are apparent, but also how far Kalmar reached regarding flexibility when shifting to new models, collaboration with production engineering, customer orientation, and cooperation with suppliers.

Kalmar's final touch was when the plant in 1993 shared the first position in J. D. Powers' initial quality study of the customers' appreciation of the 1993 940 model.

3.2 Development of the organization strategy

When Kalmar in 1987 was to begin assembling the 760 model, the plant had to be expanded since the new model had a larger material and work content. One of the new departments was team area 4/5. Several (parts of) functions were assembled there: brake pipes, booster, ABS unit, pedal arrangement, climat unit, cable harness etc. Brake pipes, booster and climat unit were pre-assembled (as were some minor components).

The production strategy was, in all important aspects, the original one in the Kalmar concept. Assembly was done on carriers, successively moving through the department between the incoming buffer of four and the outgoing buffer of three carriers. Control was centralized and speed dependent on production volume. The components were stored along the line. This production strategy was constant during the period with the exception of a remake of the materials handling.

The organization strategy, on the other hand, underwent stepwise alterations. When the department started in 1987 the direct assembly was very conventionally organized, and hardly reached the original intentions. Along the line were twelve stations, each manned by two persons assembling at the car's left and right side, respectively. Station time was around four minutes, after which the car proceeded to the next station. Besides the pre-assembly there was materials handling, instruction, and controls/adjustments along the line. All three were operated by two persons not involved in any job rotation. The department was headed by a foreman.

After a few months, work content were prolonged by letting the assemblers follow the same car between stations. In this way, balancing losses were reduced and the autonomy of the assemblers increased. In 1989 the work cycle had expanded to about 30 minutes.

The team area development project, when it started in 1988, affected team area 4/5 mainly by bringing the indirect positions into job rotation. The persons who had formerly been assigned these tasks began, somewhat resistantly, to work about half their time on the line. At the same time many of the assemblers were educated for materials handling, instruction, or control and adjustment. Also, a group leader position was created, designed partly to replace the production leader, who in turn received wider responsibilities when the production manager at the next level was removed.

In team area 4/5 changes continued, outlined by the Dialogue project and then the process development. First, assembly was broadened to incorporate the whole line in the department; assemblers still worked two and two. The deciding step was taken in 1992 when each assembler began to assemble the department's part of the car by himself, with a work content of approximately 65 minutes (variations in models and variants not accounted for). Through the shift to a long line, balance losses were eliminated. The shift to one assembler per car meant that the system losses and irritation, caused by the two assemblers seldom working at the same pace, disappeared. Every day six hours of assembly on the line was followed by two hours of pre-assembly (the latter with rotation between three major tasks).

Simultaneously with the shift to one assembler/car, the designated station for control and adjustment was abolished. Each assembler assumed responsibility for leaving a satisfactory work, and time for this was assigned in the balance. As a result, defect frequency decreased by 90% and the crew could be reduced without causing a higher work pace.

In parallel with these steps the indirect positions were fully integrated into the rotation order. 13 of the employees, meaning roughly half of them, took turns in being group leader, instructor and materials handler during half a week to a week with two–three weeks in-between (each individual rotated on just one of these three positions).

Thus, within the frame of the existing production strategy, a far-reaching development of the organization strategy took place stepwise. Work content increased radically, as did autonomy. A prerequisite for this was a notable increase in competence. There was no longer the often irritating dependence on a co-worker, and the collective responsibility for the production was significantly larger. Another aspect was that balance and system losses were reduced, and, hence, productivity increased. The quality level rose dramatically, which contributed to crew cuts not only in this particular team area, but also in the final control and adjustment areas of the plant.

If Kalmar had been allowed to continue, there were ready-made plans within the team area on how to further develop the processes in the area. The number one goal was to have the car immobilized in a dock during assembly. The shift to dock assembly would take place in connection with

the 1974 carriers being replaced by 'taxicarriers'. In the investment plan this was scheduled for 1995/96. It is likely that simultaneously several team areas would have been joined, meaning increased work content. Furthermore there were plans to take over most of the production engineering work, as well as some supplier and perhaps also customer contacts.

3.3 A new production strategy needed to further develop the organization strategy

The first thing that took place once the body had been lifted to the second floor was removing the doors. While the body on its carrier went through the entire upper level loop, the doors were assembled to be remounted on the car before it went down to the marriage point. The door assembly was divided into left and right door assembly. Also the first thorough electric function inspection belonged to team area 17/40.

Whereas the doors were removed and remounted on the line as was the electric function inspection, doors were assembled off the line. The separate door assembly meant a freedom in the choice of production layout, relative to the rest of the factory. From the start this resulted in a more conventional layout for the door assembly than for the departments along the line. The doors were transported from station to station by a conveyor. Work content was limited to 3–4 minutes, job injuries were noticeable, and balance and system losses great. In order to tackle these drawbacks work organization was changed, so that assemblers went from station to station, thereby assembling the whole door. However, job injuries (and losses) continued on a high level. The new work mode added a dependence on the pace of the co-workers and consequently an irritation in the group. In addition to the direct work there was materials handling, instruction, and control/adjustment, positions which continuously were held by the same persons.

The already strong incitements for a change were markedly enhanced when absenteeism and personnel turnover rose sharply during 1988 and 1989. As the Dialogue project was launched in the plant in the course of 1989 it gave the door assembly unit a possibility to develop a new production layout and work organization. In a first step there was in 1990 a shift from the old serial grouping along a line to a parallel grouping in individual docks (this concerned only the door assembly in itself, not the removing and remounting). When the doors had been taken off, they were collected four and four on carriages, placed in an incoming buffer. There they were gradually picked up by the assembly workers, who also picked up the material that was to be assembled. Assembly took place in a newly constructed fixture, where it was possible to raise, lower, and also tilt the door. From an ergonomic point of view this was a major step forward in production technology. To get the material and assemble the four doors took around

60 minutes. The doors were then left in an outgoing buffer, waiting to be remounted on the car.

Through the shift to individual assembly in parallel stations the dependence between the assemblers, and thus the system losses and irritation, was eliminated. Even more important was that the new conditions did not cause one single new job injury. On the contrary, assemblers who had previously been injured could be rehabilitated and returned to work.

In 1992 the time had come for the next step, which meant that the indirect tasks were distributed so that all employees in the team area could take part in them. The designated positions for control and adjustment were abolished since each assembler was to do his own quality checks. Some of the materials handling, as has already been seen, was assigned to those assembling the doors. The rest of the materials handling, the instruction job, and the new group leader position were rotated. However, not everyone wanted to participate in this rotation, despite persuasion attempts.

To the door assembly, the new production layout was a necessary condition to the new way of organizing the assembly work and thus to the improved working conditions; the new production technology also had an important role. In the second step, only the organization strategy changed. Taken together, these measures lead to reduced losses and, hence, increased productivity, a defect frequency reduction of more than 80%, and increased work content and autonomy whereas physical and mental stress were reduced enough to eliminate job injuries.

Still, there was plenty left to develop further, had the Kalmar plant not been closed in 1994. The team area was divided into three groups, where the first assembled the right doors, the second the left doors, and the third removed and remounted the doors as well as handled the electric function inspection. Only as an exception did the employees rotate between these three groups. A next step could have been shifting to two groups, both removing, remounting and assembling the doors. The small number of assemblers who shifted between the reversed assembly of right and left doors could, presumably, also have shifted between these two groups.

3.4 A radically new production strategy, which also made possible a new organization strategy

After the bodies had descended from the upper level they were, in the same step, married to the chassis. This was the start of an extensive work to join the various parts of the driveline to the components which had been assembled on the upper level. The single biggest project during the last years of the Kalmar plant took place in this area and a total amount of 30 million SEK was invested.

When Kalmar started in 1974, the assemblers installed the driveline to a

large extent working above the head under a special 'high carrier'. Such a work position is extremely demanding. Muscular strain and injuries soon became a big problem. The situation did not improve much by a shift from fixed station balances of 3–5 minutes to the assemblers following the high carrier from station to station, meaning a work cycle of 15–20 minutes. The already problematic situation got much worse in 1987, when 'unsuccessful constructions increased the frequency of operations uncomfortable or damaging to the human body'. Job injuries became more numerous, and the combination of poor working conditions and a more overheated labour market made absenteeism and employee turnover rise further and forced the radical transformation that was made in 1990.

The change of the driveline instalment process consisted of a number of important components. In terms of production layout there was a shift from serially grouped stations, where assembly was done on a moving object, to nine double docks grouped in parallel, where the objects were not moving (a tenth dock was used for instruction and in case of job injuries). The outgoing buffer was placed next to the line, similar to docks. This made it possible to change and restore the car sequence in a simple way. A central material inventory for the whole area was arranged, where the assemblers picked the material themselves. The role of centralized production control in the area was reduced. The production technology changed through the addition of a taxi carrier, which transported the cars from the marriage point to the docks, and from there to the outgoing buffer. A tilting equipment for dock assembly was presented. Work organization developed inasmuch as the assemblers worked two and two in the docks, each pair not depending on any other. The indirect work was divided among the assemblers (a few years later than had been planned).

The change must be regarded as a big success. The new production layout eliminated not only a large part of the traditional balance losses, but also those which were the result of the increasing number of car and engine variants. Owing to that, the crew could be reduced. The new production layout, the new buffers, and the new carriers, all in combination with the new work organization, meant a greater flexibility and thus a better ability to handle both disruptions and changes in the production.

For the assemblers work content increased markedly. The assembly cycle lasted about an hour. To this must be added materials handling, control and adjustment, pre-assembly, some maintenance work as well as some production engineering. Autonomy increased, not only due to the larger work content, but also to the independence between the docks, the more flexible equipment, and the less centralized production control. All this required substantially more competence, and the need for education was underestimated in the beginning of the project.

The most notable consequence was the strong reduction in physical and mental stress. The shift from work above the head on a moving object to assembly on a stationary object with tilting possibilities was revolutionary, and job injuries almost disappeared entirely.

4. The new Kalmar concept in comparison to new Japanese assembly plants

From the very beginning the Kalmar plant was a break from the Fordist tradition. Despite the built-in weaknesses in the Kalmar concept, Kalmar rapidly established itself as Volvo's foremost assembly plant. In 1987/88 began what was to become a powerful renewal and development of the original concept. At the time of the close-down in 1994, Kalmar appeared as a factory of international calibre.

These improvements were a fact in the fall of 1992, when Volvo decided to close the factory. Kalmar had reached even further accomplishments when it was time to close in summer 1994. Furthermore, at that time, Volvo's sales had increased so rapidly since the end of 1993 that the Kalmar plant would have been needed to manage the deliveries.

In connection with the continued renewal of Volvo Car Corporation's only remaining assembly unit in Sweden, the Torslanda plant in Gothenburg (which has a very traditional layout and organization), the Japanese production philosophy seems to be a model to the management, probably much due to the cooperation with Mitsubishi in the joint plant in the Netherlands. Should the closing of Kalmar (and Uddevalla) be seen as a sign that the triumph of the Japanese car producers has provided the traditionalists in the management of Volvo Car Corporation (and the metal workers' union in Torslanda) with the deciding argument to get rid of assembly concepts that were never really accepted?

Interesting enough, scientists (Nomura, 1993; Shinoda, 1993; Berggren, 1993c) have pointed out the connection points between Volvo Kalmar and the new assembly plants in Kyushu and Tahara, which Toyota has put into operation in the 1990s. These new units differ in many ways from Toyota's older plants and, hence, also from the picture sketched in the well-noted MIT study (Womack et al, 1990). There would be much to say about that picture and about what is said of Kalmar and Uddevalla, but I refrain.

A striking similarity is that behind Toyota's new approach in the newest plants was the increasing resentment of the workers to accept the more and more impoverished and strongly predetermined tasks; exactly the same situation that 20 years earlier made Volvo launch a new concept. The goal of the Kalmar plant was that the employees should be able to find 'meaning and satisfaction in their work... without neglecting efficiency and economic

results...’ (Gyllenhammar cited in Agurén et al, 1976,pp 5–6; Agurén et al, 1984, p 18). To achieve this, work was organized in independent work teams. However, the organization around these teams remained rather traditional. In a paradoxical way, the focus on work organization seems to have counteracted its purpose. Things didn’t get moving until around 1990, when work organization was no longer viewed as an isolated goal in itself, but was put in relation to the development of the whole operation.

In several team areas a radical development of the work organization took place. Work cycles in the assembly task itself expanded to around an hour. Indirect tasks such as materials supply, quality control and adjustment, was merged with the assembly work. Job rotation between the extended balances was also enhanced. Production and personnel planning were, to a large extent, delegated to the groups as was part of production engineering. All this required a considerable competence growth among all employees. The development during the last years can be seen as another breakthrough for an economically and socially better work organization.

When it comes to organization strategy none of Toyota’s new factories come even close to the original Kalmar concept. In the assembly work along the line, work content is limited to one or a few minutes, to be compared with the 15–40 minutes which Kalmar had from the beginning, and which in the last years became around an hour in large parts of the factory. The indirect work off the line does not compensate for the job fragmentation along the line. The functional and hierarchical differentiation in the other parts of the Japanese plants is taken much further, which partly can be explained by the fact that they are so much larger. Taking Uddevalla into consideration, it must be said to represent another step ahead compared to Kalmar, since the assemblers were able to assemble the entire car (although only a minority did so).

In terms of production layout, Kyushu and Tahara resemble the original Kalmar concept through their serial flow divided by buffers. However, in the last years development in Kalmar proceeded further inasmuch as parts of the factory were equipped with taxi carriers. In connection with this dock assembly returned, this time with (still) more work content. In these areas production control was decentralized and the buffers placed next to the line, so that it was possible to use them to restore the sequence between the cars, when this for various reasons was disrupted within a team area. Together these measures meant a parallelization of the assembly within each team area, a step which was also taken by door and engine pre-assembly. The result was greater work content, autonomy, efficiency, and flexibility. In terms of production layout, Uddevalla once again represents a step ahead by its complete parallelization, which made possible assembly not only on non-moving objects but on entire cars.

Toyota's ambition to develop ergonomically better equipment for handling, assembly, and transports, also resembles the corresponding strive at the start of the Kalmar plant and the big push in that direction during the last years. The latter also resulted in that areas earlier under heavy stress did not cause any new job injuries.

The strive towards a greater work content at the start of the Kalmar plant differed from the Fordist personnel strategy. The increasing involvement and commitment in the last years meant a continuing reorientation. Here, again, Toyota's strategy in the new plants resembles the original Kalmar concept. There are, however, no similarities regarding relations between employees and the company outside of working hours, even though Toyota now seems to put less emphasis on this condition, so distinctive to the Japanese labour market.

What has just been said can largely also be applied to the change strategy, which in Kalmar was traditional up to the last years, when possibilities for a much wider participation from many of the employees were created. Without the compulsion, which seems to be connected with the Japanese use of 'kaizen', Kalmar got very far in terms of constant improvements. In this respect, Toyota also seems to have reduced the pressure on employees to participate.

Such a short comparison with Toyota's Kyushu and Tahara plants could easily be misleading. To make up for that, I would like to point out that there is much indication of the superiority of the Japanese plants concerning the development of constructions easy to assemble, the successive automation of parts of the assembly, and generally the finding of new solutions in production engineering.

Volvo's now resigned president P. G. Gyllenhammar (1991, s 238–42) does not perceive a contradiction between the Kalmar plant and lean production. With special regard to the competition with the Japanese car industry he says that 'the production philosophy which has grown out of the Kalmar concept is not a disadvantage'.

The influences between Japan and Volvo form a paradoxical pattern. Whereas Toyota's latest factories show notable similarities with the concept that Volvo developed in Kalmar in the 1970s, what Volvo now is introducing in Torslanda resembles the concept that Toyota stood for during the 1980s. The Volvo management does not seem to understand that the Kalmar plant in many ways had gone much further in the direction Toyota now is headed.

References

- Agurén, S et al (1976), *Volvo Kalmarverken*, Rationaliseringsrådet SAF-LO, Stockholm.
- (1984), *Volvo Kalmar revisited: Ten years of experience*. Efficiency and participation development council SAF-LO-PTK, Stockholm.
- Berggren, C (1993a), *The Volvo experience. Alternatives to lean production*, Macmillan, London.
- (1993b), *Mästarprestationer eller mardrömsfabriker?*, Royal Institute of Technology, Stockholm.
- (1993c), *Toward normalization?*, Paper presented at the Industrial Relations Research Association workshop on 'Industrial transformation and labor relations in Asia', Boston 3-5.1 1994.
- Gyllenhammar, P G (1973), *Jag tror på Sverige*, Askild&Kärnekull, Stockholm.
- (1977), *People at work*, Addison-Wesley, Reading, Mass.
- (1991), *Även med känsla*, Bonniers, Stockhom.
- Nomura, M (1993), *The end of Toyotism?*, Okayama University, Tsushima, Okayama.
- Sandberg, T (1982), *Work organization and autonomous groups*, Malmö: Liber.
- Shinoda, T (1993), *Japanese capitalism and 'Toyotism' – is it a new model of post-Fordism?*, University of Ritsumeikan, Kyoto.
- Womack, J et al (1990), *The machine that changed the world*, Rawson Associates, New York.

Part II

The performance
of the Uddevalla plant
in a comparative perspective

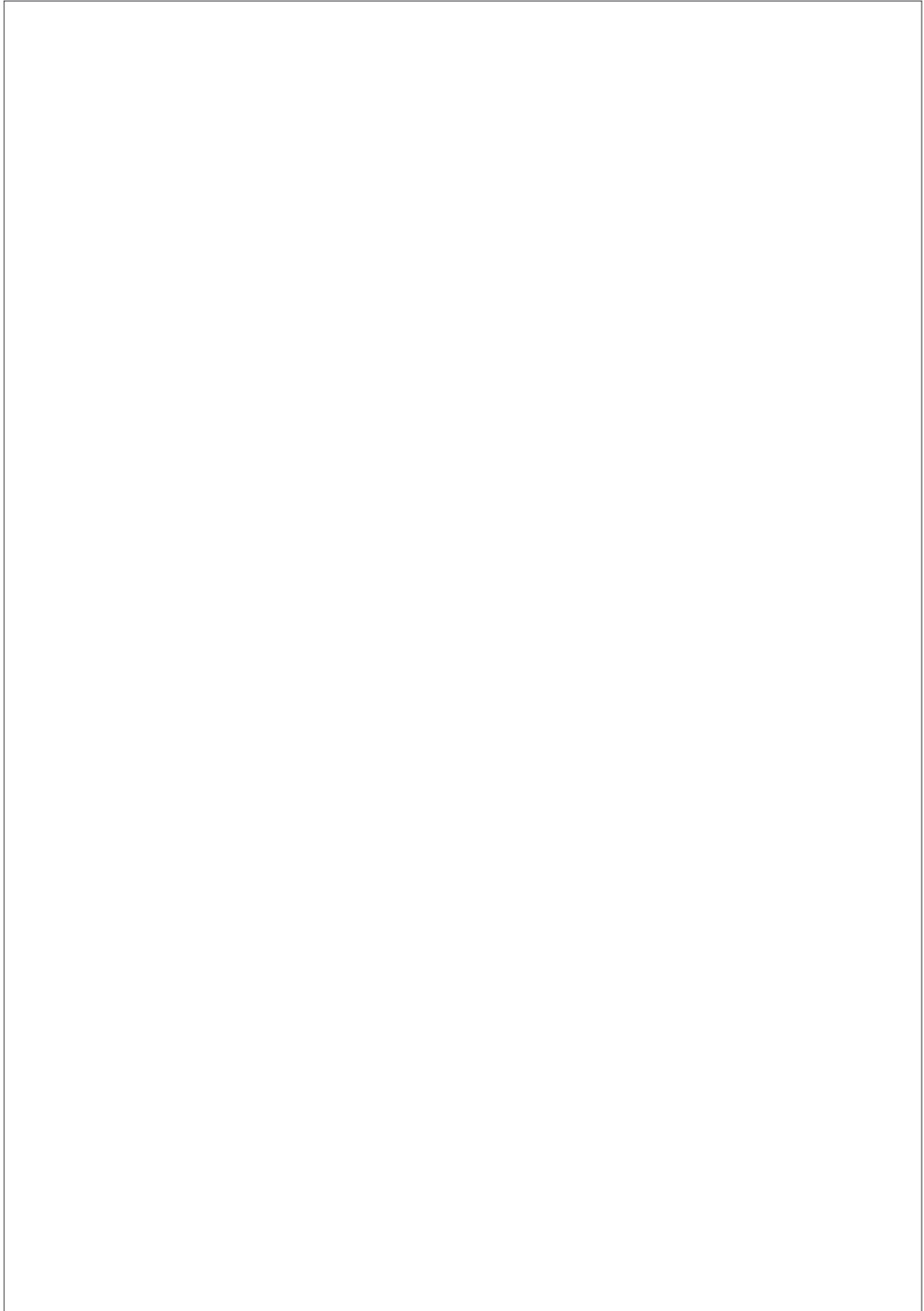

The fate of the branch plants – performance versus power

Christian Berggren

Volvo has become a byword for advanced thinking in work design, in new forms of production, in collaborative implementation, in worker participation and satisfaction ... When practitioners, be they management, trade union or academic have to give shape to possible new futures, alternatives to Taylorism or examples of best practice then it is to the plants such as Vara, Kalmar and later Uddevalla that they turn.

Peter Cressey (1993), *Kalmar and Uddevalla: The demise of Volvo as a European Icon*.

Kalmar and Uddevalla are the best known symbols of the Volvo trajectory in production design and work organization in the 1970s and 1980s. This chapter will evaluate their performance, scrutinize the official justification of the closure decision and discuss factors more fundamental in this context than assembly hours – product policy and organizational power. Finally, the experience of Uddevalla will be analysed in the context of learning. Developments at the plant are confronted with the recurring notion that standardized and highly fragmented job structures are a precondition for organizational learning in labour-intensive production.¹

The Kalmar plant, which began production in 1974, represented the first important step in the search for viable alternatives to the assembly line and its Taylorized jobs. Its most noticeable innovation was the individually controlled carriers, which replaced the mechanically paced conveyor belt. The total assembly was divided into twenty different sections, and within some of these sections, it was possible to dock the carriers into parallel stations, thus increasing the work cycle to 20–30 minutes. With the help of buffers between adjacent sections, workers had some opportunity to vary their work pace independently of the main flow. In addition, the carrier technology made ergonomic changes possible, through so-called tilting of the car bodies. One of the purposes of the plant design and division of the line

into distinct sections was to foster in responsibility and team spirit. Kalmar was a small operation, with a capacity of 30,000 cars per year per shift; but Volvo planned to build another factory of the same type in the United States with the capacity to make 100,000 cars a year. Three years after Kalmar started production, Volvo's profits fell drastically. As a result, plans for the U.S. plant were shelved and the climate within Volvo became much more conservative. By this time, Kalmar had been broken in with disappointing results. Workers appreciated the team-based work organization, the possibility of varying the work pace, and the physical work environment. However, assembly time per vehicle was the same as at the main plant, Torslanda in Gothenburg, and adjustment work was as extensive. As a result of Volvo's problems in the late 1970s, a comprehensive rationalization programme was launched at Kalmar. In 1984, ten years after the factory had opened, Kalmar's performance was much better. Assembly hours per car were 25 per cent lower than at Torslanda (a difference which has since persisted), quality was high, and overhead costs were very competitive.

A short time after this evaluation the planning of the Uddevalla plant started. Unemployment was again very low in Sweden (less than 3 per cent) and automakers had a lot of difficulties in recruiting and keeping workers in traditional industrial jobs. At the same time, the increased demands for flexibility and high quality made firms dependent on a stable and committed workforce. Creating new production systems adapted to human demands was seen as a strategic necessity for coping with personnel problems during the 1990s. In this situation, the influence of the unions in the companies' planning and investment decisions also increased. The result was the bold new design of the Uddevalla plant, a radical continuation of the process started 15 years earlier.

Workers' utopia or neo-craft cul-de-sac?

The plant immediately aroused a lot of international interest and soon became the host of impressed visitors. Some very influential automotive researchers were deeply suspicious, however. In the book *The Machine That Changed The World* Womack, Roos and Jones from Massachusetts Institute of Technology (1990:101) disparaged both Kalmar and Uddevalla as 'neo-craft nostalgia', arguing that '... productivity of the Uddevalla system is almost certain to be uncompetitive even with mass production, much less lean production'. In an interview in *The New York Times* (July 7, 1991) Womack's criticism was even more trenchant, asserting that 'Uddevalla is not in the ballpark ... It's not even in the outer parking lot of the stadium. Frankly it's a dead horse'.

The decision to close the two plants raises an important question. Was

the Volvo trajectory a cul-de-sac, a temporary adjustment to an ‘abnormal’ labour market (no unemployment, strong unions, comprehensive social welfare), easily dispensed of in these Swedish times of capitalist normalization? Were the two innovative assembly plants just noble experiments, doomed to fail in the competition of the 1990s? The answer is no. In terms of productive and commercial performance Uddevalla displayed a remarkable potential and in terms of engineering competence and quality Kalmar was an irrefutable success, certainly one of the European auto plants with the best quality record. This chapter will focus on Uddevalla, the most controversial of the two plants, but I will also summarize Kalmar’s achievements. In October 1992, Uddevalla was thoroughly evaluated against the line assembly plant Torslanda in Gothenburg. By this time, the Uddevalla plant had only been in operation for three years, but nonetheless, matched the Gothenburg plant’s productivity, surpassed its quality and emerged as Volvo’s internal benchmark in terms of market responsiveness and customer orientation. Let me first summarize the achievements of the plant, before they are presented in detail.

1. *Productivity: A 50 per cent improvement 1990–1992.*

After a slow start Uddevalla took off and in 1991 reached the level of the Gothenburg mass-production plant. From the last quarter of 1990 to the last quarter of 1992 Uddevalla cut the assembly time at an average rate of one hour per month.

2. *Quality: A clear edge in customer satisfaction.*

In the early 1990s, both Gothenburg and Uddevalla improved their quality records considerably, but according to American customer evaluations, surveyed by J D Power, Uddevalla was clearly ahead of Gothenburg. In the autumn of 1992, the rate of improvement was particularly rapid at Uddevalla.

3. *High flexibility: 50 per cent lower tool and training costs at the annual model changes.*

At Uddevalla, flexible production design and highly skilled teams rendered the yearly model conversions much easier than at line assembly plants. For the three years 1990-1992 this resulted in very substantial cost savings in both tools and training. The time required to return to normal productivity after an annual model change was half the time needed on the lines at the Gothenburg plant.

4. *Combining customer order assembly and short delivery times.*

In the autumn of 1992, Uddevalla started building all cars for Europe according to customer orders only. As a result, dealers could offer customers individually specified cars within 4 weeks, instead of persuading buyers to accept prespecified ‘plan cars’. The total lead-time was cut from two months in 1991 to one month in 1992, and further reductions

were planned for 1993. The savings in finished product stock equaled the value of the entire assembly time! Moreover, since 'plan cars' must be heavily discounted in flat markets, every custom ordered car also implied a significant commercial savings. Many of these points fly in the face of conventional wisdom, so let me explain them somewhat more carefully.

Rapid productivity improvement

One of the most widespread performance indicators in car production is assembly hours, in spite of the fact that assembly only represents a minor fraction of total manufacturing costs. During its first year of operation final assembly time per car at Uddevalla averaged 70 hours, including materials handling, maintenance and other indirect activities, not including salaried positions. This high level was anticipated, however, since the plant focused on training new teams, expanding its product range and bringing new assembly shops on stream. Late in 1990 Uddevalla started to improve rapidly. The last quarter of that year the plant scored 59 hours/car, and from then on assembly time per car was reduced by one hour every month on average. The second half of October 1992 the figure was down to 36 hours! (It must be noted that this and subsequent figures are not comparable with the assembly time that MIT researcher John Krafcik and his colleagues calculated at various car plants. The aim of the MIT study was to compare data across plants and countries. Thus they only registered a standardized sub-sample of assembly activities at each plant and did not compute total assembly times.)

According to the MIT-study, Uddevalla would never reach the productivity of a line plant. Nevertheless, in mid-1991 Uddevalla's performance equalled Gothenburg's assembly line. Admittedly, at this time the Gothenburg plant was not very productive in European terms, a main reason being the drastic decline in Volvo's sales and volumes. As a result, the plant was operating on a very low capacity level. Inspired by Japanese methods, a new management eliminated the overstaffing and launched a comprehensive productivity programme, that strongly focussed on process quality. As a result, Gothenburg overtook Uddevalla in early 1992, but in the second half of that year, Uddevalla accelerated. In the month prior to the shut-down decision, the two plants competed neck-to-neck, but Uddevalla had a steeper learning curve. Interestingly, within Uddevalla there were no significant differences between assembly teams working in long cycles (1.5 hours) and teams working in very long cycles (3.5 hours). Shorter cycle times were somewhat easier to learn, but the assembly task in these teams required a more elaborate form of group interaction. In fact, one of the most consistently productive

units was a mini-group of two female assemblers who, working as a pair produced one car per day on regular basis.

Uddevalla had abundant potential for further rapid improvement. None of its managers doubted that the plant could reach the target of 25 hours per car in the middle of 1993. In fact, most were absolutely confident that Uddevalla would beat the line plants in straightforward productivity terms. If they were correct in their assumptions, Uddevalla's critics would obviously be proven wrong. I will return to the issue of productivity performance and organizational learning later in this chapter.

A quality edge

Quality is the second general performance measure of Volvo's assembly operations. In 1991, Volvo's three assembly plants in Sweden were roughly equal. Kalmar was the first plant to introduce and train all operators in a rigorous system for quality assurance, from error detection, problem analysis and application of countermeasures, to follow up. Originally, Volvo had expected Uddevalla's highly skilled and motivated teams to attain superior quality more or less automatically. Only in 1992, a new plant management started to approach quality in the same rigorous way as Kalmar. New forms of team-based self-inspection was introduced, for example that workers should always check each other's work when shifting positions within the teams. The result was a marked enhancement of the plant's quality performance. According to surveys carried out by J D Power for the model year of 1992, Uddevalla built cars of the 900-model had 124 complaints per 100 vehicles within ninety days of purchase, whereas Gothenburg cars scored 144. The average for European cars in the United States was 158 for this year. During 1992, Volvo improved its quality ratings markedly. When the figures for the model year of 1993 were released from J D Power, Volvo had advanced more than any other automaker. The 940-model improved from 132 to 87 complaints – with the the two small-scale plants, Uddevalla and Kalmar, improving most rapidly of all.

Superior flexibility in changing models

High flexibility was a third import advantage of Uddevalla's parallel team assembly and broad worker competence. One indication was the low effort needed to introduce annual model changes at the plant. The three model changes between 1990–1992 were introduced at lower costs per car, between 25% and 50%, compared with the Gothenburg plant. Uddevalla needed less investment in tools and training, and returned to normal productivity in only half the time Torslanda did after a model change. Normally, Volvo's

annual changes are quite insignificant. That was the case in 1992. That year the best Uddevalla teams needed to build only 2–3 cars (approximately one day) before resuming 95 per cent of the normal production pace. The least efficient teams needed 5–6 cars, or two days. One of the advantages of the parallel team system was that support staff could concentrate solely on helping those teams that were in most need. On the line at the Gothenburg plant, there is normally one day's gap between the old and new annual models. During that time industrial engineers and subforemen relocate materials, adjust equipment and provide new tools. Assembly workers are informed about the changes, but seldom participate very actively. By contrast, the assembly teams at Uddevalla themselves implemented the changes, they studied the new instructions and rearranged their workplaces. The system of materials provision, the kits, were by themselves an important means to help assemblers learn the new annual model.

The head of the plant's industrial engineering department emphatically stressed:

It's a myth that our parallel and long-cycled assembly requires more tools and longer time for training when changes are introduced. Our cost for training and preparing people for new models has been only half that of the Gothenburg plant. The main reason is the enormous competence and skills of the assembly workers and materials handlers.

Parallel assembly at Uddevalla meant that cars were built in many places simultaneously. Before the plant came on stream, it was generally expected that this would result in considerably higher tool costs. An evaluation of the model changes between 1990–92 showed that the opposite was true. One reason was the plant's deliberate low-tech strategy for the assembly process. Simple, flexible tools were substituted for complex dedicated equipment. As a result, existing tools could be modified instead of replaced when a new model year commenced. At Volvo's other plants, process engineers had always accepted the product designers assembly specifications. At Uddevalla, engineers required designers to standardize and modify technical requirements in order to minimize the need for extra tools. In that way the annual model change became a much more interactive process than it used to be, resulting in considerable cost savings.

A car dealer's dream: customized assembly, short delivery times

In Volvo, as in many other car companies, efforts to improve efficiency and productivity have focussed on the industrial system, the components supply, and above all, the assembly hours. Much less attention has been devoted to

the efficiency in the commercial and distributional systems. The MIT book *The Machine That Changed The World* is a good example of this narrow production focus. The book abounds in assembly hour statistics from various plants, but there is not one statistic which compares lead times from customer order to delivery between different manufacturers. At Uddevalla, there was an early awareness of the importance of fostering close contacts with the market. Volvo's system for plant evaluation, however, concentrated narrowly on parameters such as assembly hours and quality indices. In the company's strongly departmentalized organization, production was strictly separated from product design and marketing. Uddevalla had to focus on improving its assembly performance, and nothing else. In 1991, though, when productivity had reached the Gothenburg standard, it was possible to widen the focus. A large sample of cars was selected for a detailed study of lead times, which revealed that if a customer ordered a particular car, the average time from order to delivery in Sweden was two months, with a range from one to four months. Many factors served to increase the delivery times: the rigid planning system, the functional specialization with high barriers between production and marketing divisions, and the complex product structure with its high option content. At this time, only 20 per cent of Uddevalla's volume was custom-ordered. The overwhelming majority of the cars were assembled according to the company's central scheduling system. For these plan cars total cycle time was even worse – on average they took twelve weeks after production to be sold and delivered. The depressed auto market, where dealers had to work hard to get the cars moving, contributed to the excessive lead times. This situation made it all the more important for Volvo to overhaul its ordering and delivery system.

Uddevalla took the lead and established direct communication with all Swedish dealers. The plant also pioneered direct deliveries from the factory to selected dealers. Soon Volvo's car plants in Gothenburg and Ghent also started to reorganize their relations with dealers and to compress delivery times. Beginning on October 1, 1992, Uddevalla took another and most important step. The plant abandoned the central scheduling system that specified the car mix seven weeks prior to production. Instead Uddevalla started to assemble all cars for the Swedish market on customer orders only. One month later this principle was extended to the whole European market. Uddevalla told dealers in Europe that the plant would not promise any specific delivery times for cars that had been scheduled by the central planning system, on the basis of market forecasts. By contrast, they would guarantee delivery within four weeks of any custom-ordered car. Basically, Volvo Uddevalla now did the same as Toyota rather unsuccessfully had tried to initiate ten years earlier, when its sales subsidiary was merged with the manufacturing arm, and direct links between sales people and factory

scheduling was established. Uddevalla planners had to do an enormous amount of manual rescheduling to adapt materials supply and production planning to the customer orders, but did so happily since the response from European importers was overwhelming.

The customer orientation at Uddevalla built on the strength of its flexible production system. To remain productive, the many parallel teams and materials handlers did not need any specific sequencing of cars with different option contents (for example, every second car a turbo, every third an automatic transmission, every fourth a 16-valve engine, etc.). Rather, the introduction of customer order-planning provided an additional motivational advantage for the teams. Now the teams knew that the cars were not to be stored in a warehouse somewhere, but delivered directly to individual customers. The plant took a pride in taking on difficult requests. Once, for example, the plant received an enquiry from a journalist living in Britain. He was going to Stockholm in one week and wanted a car with highly unusual equipment to be delivered at the time of his arrival. The marketing department in Gothenburg considered the request impossible, but Uddevalla and the local dealer managed to get the car ready in less than one week. By contrast to Gothenburg, such requests were not seen as 'disturbances' but as inspiring challenges by white collar staff as well as assembly workers.

In 1991, when the programme to compress lead times started, 20 per cent of the assembled cars were custom-ordered and the rest were plan cars. In November 1992, on the eve of the shutdown decision, 70 per cent of the cars were specified by individual customers. The corresponding figure at Volvo Gothenburg was 35 per cent. In one year, Uddevalla had reduced the total lead time by half, from 60 to 30 days. The plan was to cut it by half again, to 14 days, in the next few years. The move to custom-order assembly was Uddevalla's single most important economic contribution. By ceasing to build cars scheduled by the central planning system, the plant reduced the time from factory to customer by ten weeks (from twelve to two weeks) and further improvements were in the pipeline. With an estimated capital cost of 100 kronor per car and day, this saving matched the total cost of final assembly (35 hours times 200 kronor an hour)! Moreover, in the depressed market of the early 1990s, Volvo dealers normally had to grant customers a discount of 3000–4000 kronor on every 'plan car'. By contrast, custom-ordered cars could be sold at the full price.

All in all, the change to customer ordered assembly with short delivery times, represented cost savings of a magnitude unparalleled by any programme directed at reducing assembly hours, the favourite object of media interest and managerial effort. The beauty of Uddevalla's production system was its ability to offer customer order assembly and short delivery times without compromising productivity and quality. To quote one of its manag-

ers: 'This plant was poised to become the most efficient plant for customer order assembly in the world!'

Uddevalla's aggressive move to custom-order assembly forced the Gothenburg plant to rethink its traditional ways of relating to the market. Since October 1992, significant progress has been made in Gothenburg, increasing the share of customer ordered cars of the plant's output. In a truly customized system, however, work load will be very uneven. A stream of highly specified and labour intensive cars might be succeeded in unpredictable ways by cars which have a low option content. Such variations is difficult to accept at a conventional plant, lean or not. In order to maintain a steady work flow on the long assembly lines, it is vital to sequence and even out production. Thus, it is very difficult for the Gothenburg plant to accomplish a complete custom-order assembly in the way Uddevalla did, without seriously impeding productivity and jeopardizing its targets for reduction of assembly hours.

The difference between Uddevalla and Gothenburg did not only pertain to the degree, but also to the span of customization. When planners at Torslanda started to customize its production schedules, they were content to compress the time elapsed from the reception of the order to the shipment to the dealer. For car buyers, and for the company's cash flow, however, it is the total cycle time, from customer order to customer delivery that makes a difference. In contrast to Torslanda, Uddevalla set out to measure, monitor and integrate this total process. Most Volvo cars are sold with a lot of 'extras', for example radios, telephones, tow hooks, etc., that are installed by the dealers. That helps them keep workshops busy and provides an additional revenue stream. To customers, though, this division of labour between plants and dealers means high costs, less reliable quality and extra delays. Uddevalla's flexible assembly would have no problem producing fully equipped cars, including all features traditionally handled by dealers. Such an integration would result in substantial advantages: lower installation cost, reduced handling and warehousing, higher and more consistent quality, shorter lead times. For example, it is much more efficient to mount a tow hook, including necessary wire connections, when the car is being assembled, than it is to do it after-wards when several components must first be dismantled. This dismantling entails the risk of damaging other components, and quality procedures in dealer shops are seldom of the same calibre as the factory standards. According to a preliminary study, Uddevalla could install the tow hook in a third of the time taken by the dealer shops, and the reduction of the lead time was equally impressive. Beginning in mid-1993, Uddevalla's market and delivery planners had advanced plans to integrate almost all of this traditional dealer installations in the factory process, and as a result be able to produce cars that could be delivered directly to the customers. At

Torslanda, there were no such plans – for good reasons. Its assembly lines could not cope with additional variation.

A noble experiment that did not fail

In 1989, management had viewed Uddevalla as a strategic investment to meet the demanding labour market of the 1990s. Three years later these considerations were forgotten. Sweden was in deep recession and unemployment on a sharp rise. In the midst of down-sizing, Volvo had no need to recruit new workers and no problems with labour turnover, not even in Gothenburg. Uddevalla's achievements in humanizing assembly work, in constructing new tools and developing new forms of work, did not play any role for the Volvo managers who decided to lay the plant idle. Unfortunately, that testifies to a very short-term perspective in the present Volvo leadership. When the economy picks up again Uddevalla's new design and organization would have been very competitive in terms of personnel costs. At the Gothenburg plant, on the other hand, the current labour stability is deceptive. According to 30 years of experience, labour turnover at this plant will rise as soon as unemployment falls. This will not only increase personnel costs, but also jeopardize the future of the programmes for continuous productivity and quality improvement at the plant. The enhanced performance at Gothenburg remains fragile, since none of the fundamental problems of assembly work have been solved.

In the Swedish debate, Uddevalla's performance has been established beyond doubt. The plant was not a noble experiment that failed. Quite the contrary, it was a fundamentally viable model. During the autumn of 1992, a new plant management and managerial structure resulted in an accelerated pace of improvements. If the plant had been allowed to operate another year, it would have been very difficult to close it.

When the plant began operation, it was greeted with high expectations as well as strong apprehensions. Some of the expectations were not realized, but in most cases, the results were beyond all expectations. In Table 1, expectations/apprehensions are summarized and compared with the real outcomes.

Kalmar – the number 1 plant

All three Swedish plants improved rapidly from 1990 to 1992. Compared with Gothenburg, Uddevalla had a clear edge, but Kalmar was the most competitive. The plant had been in operation since 1974 and had been able to fine-tune its technical system, develop a high level of technical competence and a genuinely participative management. In 1989, a broad programme for

continuous process improvement was launched. When the new 900-model was introduced the following year, there were so many problems that management retreated to a traditional command-and-control mood, declared a state of emergency and centralized all decision-making. Soon Kalmar was back on track, however, and by 1993 the programme had become very effective. There were teams for process improvement at all levels in the organization, including the management committee. The teams themselves were responsible for setting their own targets, design and implement action plans, evaluate the results, and take corrective actions. In two years some teams reduced the number of defects from one per car to 0.02 per car. From early 1991 to early 1993, the plant reduced the average number of defects per car by 50 per cent. The corresponding improvement rate in Gothenburg was 25 per cent. According to J D Power's statistics for the year model of 1993, Kalmar cars of the 940-model reported only 54 complaints per 100 cars. That was close to the Lexus level (the figures are not exactly comparable, since Lexus owners are presumably more demanding and picky). 940-cars from Gothenburg scored 90 complaints per 100 automobiles.

Kalmar's high in-process quality resulted in superior productivity, too. The plant produced both the 940-model and the highly specified 960-model. No separate assembly figures for the two models have been released, but according to informed estimates, Kalmar needed 5 assembly hours less for the 940-model than Gothenburg. Another advantage of Kalmar was the technical competence of its engineers and operators and their ability to cooperate with product engineers from Volvo's design departments in a very productive way. The central Gothenburg department that was responsible for preparing new models for manufacturing, collaborated with all Volvo's assembly plants, Gothenburg, Uddevalla, Kalmar as well as Ghent (Belgium) and Halifax (Canada). According to engineers at this department, Kalmar was the best of these five plants, by all measures. A representative comment is the following quote (from interviews in April 1993):

Kalmar is superior. They are outstanding. Their entire attitude is quite wonderful. Nothing is impossible, only a bit difficult maybe. There is an atmosphere that is hard to describe. They always want to improve and become better. When we tested new complicated components last summer, everybody participated and supported us. Technicians, maintenance people, operators, everybody displayed the same commitment.

Most of the factors listed above were recognized by top management (albeit too late). That only means that the initial question remains, now even more puzzling. Why did Volvo decide to shut such productive operations?

Table 1.
Volvo Uddevalla. Forecasts and results

<i>Expectations / apprehensions</i>	<i>Outcomes</i>
It will never meet production targets. High efficiency requires an assembly line.	On par with the line in Gothenburg in 1991.
20 minutes cycle time is the absolute maximum for high productivity and quality	Whole car assemblers built complete cars in 10 hours.
Impossible to sustain continuous improvement because of the lack of minute standardization.	A dream plant for Kaizen. An enormous response in the assembly teams when given adequate engineering support
Absenteeism much lower than at a conventional plant.	Absenteeism lower than in Gothenburg but the difference not very significant.
Very stable personnel.	High labour turnover the first year. In 1992 only 4 per cent, but then a deep recession.
Superior quality because of high motivation and effective feedback.	Unstable quality in the first years. World class quality also requires rigorous routines and total management commitment.
Expensive to change models since every team must have a complete set of tools.	25 per cent less tooling cost per car compared with Gothenburg.
Expensive to change models since the long cycle times will necessitate excessive training costs.	60 per cent less training cost per car compared with Gothenburg.

The spurious cost savings

Volvo's official answer referred to depressed markets, heavy losses and low capacity utilization. Indeed, the automaker was in deep trouble on its main markets. In only three years, from 1989 to 1992, Volvo's total sales of large cars (the 200, 700/900 and the new 800 series) dropped by 30 per cent, from 280,000 to 200,000. The Swedish market, Volvo's second most important, virtually collapsed. Total automobile registrations plummeted from 344,000

in 1988 to 155,000 in 1992, the worst figure in more than 30 years. 1993 was projected to become even worse. For two years, the result was in the red. In 1992, the Group's operating loss was approximately 300 million dollars of which Volvo Car accounted for more than half. Management became preoccupied with immediate measures to reduce capacity and cut costs. In this situation of disastrous capacity utilization, Uddevalla's and Kalmar's character of being small and incomplete plants (only final assembly, no body or paint shops), was a fatal disadvantage. According to the official figure, presented in 1992, Volvo Car will save 350 million kronor (45 million dollars) annually by consolidating its Swedish operations in Gothenburg. This figure has been seriously disputed, however, and for good reasons. I will look at the data in more detail before proceeding to a more important issue – corporate politics and power.

First, 100 million kronor of the total 350 million is a fictitious capital saving, resulting from accounting transactions. Instead of annual depreciations, the investments at Uddevalla and Kalmar are written off at one stroke as part of the restructuring costs for the fiscal year 1992. This is of course not a real saving, but it is politically important for the new CEO, Sören Gyll, who was appointed in 1992. In this way he was able to demonstrate improvements and claim that he has turned the company around.

Second, Volvo argues that the company will save 250 million kronor in operating costs by closing down the two small plants. I will focus on Uddevalla here (The calculated savings of closing Kalmar, the most productive of all Swedish plants, are even more spurious). One of the entries on the company's list of cost savings is the expected staff rationalization. By consolidating production in Gothenburg, all staff positions at Uddevalla are eliminated. In theory, costs are reduced by 30–35 million kronor. This estimation assumes that there will be no increase in salaried positions in Gothenburg as a result of the added volume. Unfortunately, this presumption is impossible to check after the fact. There may be excess overheads in Gothenburg before the transferral, or new staff positions that are in fact volume-induced may be created under new names or motivated by model changes.

Even more dubious are the ways in which the Gothenburg economists treat the anticipated costs in plant and equipment when the 900 series will be replaced by a new platform in 1997–98. This future investment in dedicated equipment is counted backwards, put on top of Uddevalla's operating costs in 1992 and, hey presto, another 15 million kronor is saved by closing the plant now. The obvious counter-argument is of course that the plant could be operated for another five years, and then closed down in 1997 instead, without incurring any of these costs.

Uddevalla is a pure final assembly plant. This structure was a decisive political disadvantage in the power game preceding the closure decision.

The fact that car bodies had to be shipped 100 kilometers from Gothenburg's paint shop was cited as a very significant cost penalty for Uddevalla. In the first calculations it was estimated to be 25 million kronor per year. But if the total logistics of Uddevalla is analyzed, the costs are very close to those at the Gothenburg plant. The additional expense of shipping car bodies was to a large extent compensated for by less expensive deliveries of other parts, since Uddevalla was much closer than Gothenburg to several Swedish suppliers of volume components, such as bumpers and seats. As soon as the new paint shop in Gothenburg had solved its breaking-in problems and could deliver bodies at an even pace, the cost difference would decrease even further. If Uddevalla was allowed to deliver one third of its volume direct to the dealers, its total logistical cost disadvantage compared with Gothenburg would only be between 4 and 7 million kronor per annum, less than 1 million dollars.

In this way, basically all of the entries on the list of calculated cost savings could be questioned. Closing the production warehouse in Uddevalla, for example, was expected to reduce costs by approximately 10 million kronor yearly. The assumption was that the production warehouse in Gothenburg would remain the same, but this was by no means proven. Further, this theoretical reduction is not compared with the very real reduction in finished product stock Uddevalla could achieve by building fully equipped custom made cars. That omission is symptomatic of the whole exercise. Only the costs and none of the revenues of operating Uddevalla or Kalmar are listed. Uddevalla's capability to assemble specialty vehicles in a very efficient way was not mentioned, and Kalmar's quality advantage was neutralized by the assumption that Gothenburg would be able to produce the same quality.

The Uddevalla participants in the company's study team presented a very different calculation. Accordingly, Volvo would save only 50 million kronor per annum by closing the plant. This exercise did not include any revenues because of the particular advantages of Uddevalla. Irrespective of the exact evaluation of individual items in these exercises it is clear that the operational savings of shutting the plant are insignificant. The plot thickens – why did Volvo make this decision?

An unholy labour-management alliance

Towards the end of the 1980s, when sales had already started to fall, Volvo expanded production capacity in Belgium and commissioned the new plant in Uddevalla. Theoretically the two plants in Ghent and Gothenburg alone have the capacity of producing 300,000 cars, which is 50 percent in excess of current sales. In 1992, the Volvo executive came under increasing pressure from the then company's major shareholder, the French state-owned Renault

corporation. The Renault managers demanded that Volvo implement radical measures to stem the red ink and eliminate excess capacity. The Renault CEO, Louis Schweitzer, publicly criticized Volvo's production structure in general and its small-scale plants in particular. Compared with Volvo's option range, Renault's best selling Clio is a much more standardized car concept, relying on tightly scheduled mass-production plants. Renault managers could see no particular advantage in Uddevalla's flexible capability of building highly individualized cars. The pressure from Renault boosted the position of a strong traditionalist faction within Volvo. Those managers strongly believed in economies of scale and had proposed the closure of the smaller Swedish plants years before. In the internecine struggle for survival between the Swedish plants, the powerful unions in Gothenburg sided decisively with this management faction to save local jobs, at the expense of the branch plants. From 1988, total employment at the Torslanda works had been reduced from 10,000 to 5,500 and its labour organizations were not prepared to take any more. Only a few years earlier the Swedish Metal Workers' Union had been heavily involved in the development of the Uddevalla concept. The plant was seen as a model of labour-management cooperation and a proof that the Metal Workers' demand for a fundamental renewal of manufacturing was not wishful thinking. At two consecutive congresses this was the main policy line, spelt out in several documents advocating a 'Solidaristic work policy' (see 'Rewarding Work', Stockholm 1987). At the time of the show-down within Volvo all this union commitment came to naught. The Gothenburg unions were not interested in defending any innovative and humanized jobs, if they were not available to its own members in Gothenburg. The union consultant that was involved reported to the Gothenburg union and persuaded other local unions within the Volvo Group that Kalmar and Uddevalla had to be laid idle. At the decisive meeting, the labour representatives on Volvo's board supported the management decision to close Uddevalla and Kalmar!

Volvo's president, P. G. Gyllenhammar, was conspicuously absent at the press conference announcing the decision. There were many indications that he opposed it. Historically he has played an important role as an advocate of 'humanistic manufacturing'. His overall impact on Volvo was highly ambiguous, however. While promoting work reforms and decentralization of authority to the shop-floor his own management style became increasingly elitist and autocratic, thereby alienating the most able senior executives. As a result, Volvo's top management team was weak in terms of industry experience and product expertise; there was a conspicuous absence of 'car guys' in the leading echelons. Gyllenhammar's penchant for grand deals, acquisitions, mergers and far-flung diversification (to energy, drugs and food businesses), diverted managerial attention away from the core business and

created illusions that Volvo could survive without continuously up-grading process and product. Despite his lack of detailed knowledge of the auto business, Gyllenhammar repeatedly interfered with the sensitive product development, adding extra delay to an already inefficient process. In 1992, his position had been seriously undermined because of a recent strategic failure, the aborted merger with a Swedish state-owned food company, Procordia. This gave the new CEO, Sören Gyll, a strong position. To Gyll, Volvo's production structure was a matter of a very simple logic not warranting close examination; one big consolidated plant must be better than one big plant plus two small plants. When Gyll visited Uddevalla, shortly before the closing was announced, he was genuinely impressed by the plant's productivity improvement, as well as its responsiveness to customer demands and dealer requests. But his conclusion was: 'Thank you, you have done a damn good job. Now Gothenburg will have to do the same.' That comment summarizes Uddevalla's predicament. First the plant had to prove its performance and match Gothenburg beyond any doubt. Secondly, when Uddevalla took the lead and developed a number of innovative features, management took for granted that Gothenburg could do the same.

The crucial problem: new plant, old cars

Volvo's fundamental problem was not oversupply of capacity, but under-supply of new models. The 850 model, introduced in Europe in 1991 and in the US one year later, is a high-performance family car that offers a number of new safety features. The problem was that Volvo needed ten years for the development process. After the introduction of the sedan, Volvo had to spend another two years to get the station wagon ready for the market. When General Motors launched its Saturn operation, this venture combined a green-field production site, an innovative manufacturing system, and most importantly, a brand new product line. By contrast, Uddevalla had to start with an eight year old product with no relief in sight for another eight years! (The 800 cars were built in Belgium). This mismatch sealed the fate of the plant.

**Uddevalla and NUMMI:
individual versus organizational learning?**

After this overview of Uddevalla's achievements and the reasons for the closure, let us now analyse its capacity for learning in more detail. Paul Adler and Robert Cole have argued that Uddevalla was not in 'striking difference' of the productivity of Toyota's Californian joint-venture with General Motors, NUMMI (New United Motor Manufacturing Inc.). This alleged performance gap is attributed to the Swedish plant's emphasis on

individual, as opposed to organizational, learning. Workers at Uddevalla, Adler/Cole contend, lacked both the motives and the mechanisms for focusing and capturing 'the kinds of microscopic kaizen opportunities that drive NUMMI performance' (Adler and Cole 1993: 89). Now, if we want to analyse organizational learning, it is essential to distinguish between absolute performance and rate of improvement. Adler and Cole are quite correct when they report that the NUMMI plant consumes much less assembly hours to build a car than Uddevalla, or any other Volvo plant. The problem is the next step, their attempt to establish a direct link between this performance gap and the capabilities of organizational learning at the two plants. As emphasized by Williams et. al. (1992), it is very difficult to compare productivity data between plants belonging to different companies, producing different products, using different component suppliers, etc.. The problem is not to establish the number of assembly hours required, the difficult task is to interpret the differences. In the case of NUMMI and Uddevalla, the performance gap is influenced by a number of factors outside the control of the final assembly process.

First, there is an important difference in product characteristics and product manufacturability. NUMMI workers would certainly appear much less productive if they had to assemble Volvo cars.

Second, the quality of the components supplied are by no means the same. This is not only true for external deliveries, but also for components supplied by previous processes within the company. For example, according to internal Volvo studies carried out in 1990, the precision of Volvo's and Toyota's body components differed in a highly significant way (Karlsson, 1991). This, of course, affected productivity in final assembly in a substantial way.

Third, as Williams et. al. have demonstrated, capacity utilization must be included in any serious comparison of plant productivity. This factor is consistently overlooked by Womack et.al., and the same holds true for Adler and Cole. Since Uddevalla only utilized 50 per cent of its one-shift capacity in 1991-92, whereas NUMMI operated much closer to optimal efficiency, Volvo's plant is again at a disadvantage.

Fourth, the two plants are differently positioned on their respective learning curves. NUMMI adopted a mature, fine-tuned concept, developed for decades in Japan. Uddevalla on the other hand, had just established its learning curve for a qualitatively novel concept, and needed much more experience for synchronizing assembly design, materials control, worker training, management organization, information systems and so forth.

For all these reasons, I will concentrate my discussion on Uddevalla's rate of improvement, rather than its absolute productivity. Figure 1 illustrates productivity development at the plant from January to November 1992, as measured by worker hours per car. A look at this graph makes it difficult to

maintain that Uddevalla did not have a significant capacity for systematic, organizational learning. Moreover, the accelerated productivity progress in the autumn of 1992, was combined with a 20 per cent improvement in quality and with an almost complete conversion to custom-order assembly. In fact, the plant had never made as broad progress as it did during this period. The reason for this acceleration is very important and highlights a serious flaw in Adler & Cole's analysis. They emphasize the importance of organizational learning, but analyse the organization of the two plants in a very simplistic way. Thus, under the heading 'organizational design' there is only a description of the assembly teams at Uddevalla. For students of management and administration, it should be obvious that plant management and administrative hierarchies have some impact on productivity, and cannot be identified with shop-floor structures.

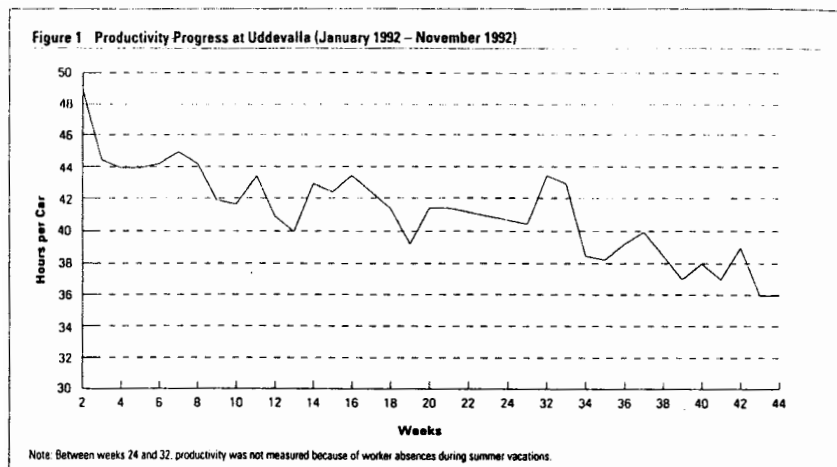

Figure 1

By focusing squarely on the shop floor level, Adler and Cole miss an important and paradoxical aspect of the Uddevalla story. The plant's advanced structure of assembly teams co-existed for a long time with a basically traditional management apparatus, located in an office building, the detached and secluded character of which was underscored by its architectural design. During the first years, the plant developed in spite of this anomaly, but in early 1992 there were clear signs of stagnation. The plant could not develop only on the strength of its team systems, a congenial plant organization and managerial structure was urgently needed. In mid-1992, after a difficult period of soul-searching, a different and very process-oriented organization was put into place, headed by a new plant manager. He had

previously been extremely successful in reorganizing the pilot plants belonging to Volvo's development and product engineering departments. In Uddevalla's new structure there was only two hierarchical levels, shop and plant management.

As before, the assembly and materials shops (on average comprising 70 workers) were organized in teams with rotating, hourly team leaders. They communicated directly with the shop managers, who in turn made up the bulk of the plant's new management committee. This participation of first-line managers in Uddevalla's central governing body reflected the very strong emphasis on process and process development (including organizational learning!) in the new organizational design. For the new plant manager, the flattening of the hierarchy was only the first step. Next, he planned to empty the office building completely, and relocate all managers and administrative officers to facilities directly adjacent to the production process.

'Some of the functional heads did not believe me', he admitted when interviewed about this plans, 'but I intended to move first, and then the others would have no choice but to follow suit.'

A third aspect of this focus on the process was a series of initiatives to involve salaried employees in direct production activities in order to build an intimate knowledge of manufacturing problem across the plant. To gain first hand experience, the new managers of the assembly shops started to learn how to assemble, not complete cars (that was in most cases too daunting a task), but at least fairly complex sub-assemblies. The remaining industrial engineers, who had been relocated from the office to the assembly and materials shops, were expected to spend half of their time building cars in the assembly teams. To bridge the still existing gap between white and blue collar workers, the head of manufacturing assigned other managerial staff, such as accountants and systems analysts, to assist the teams for a shorter period (normally one week). Initially, this program encountered vehement opposition, but in the end the reactions were very positive.

These initiatives were no cultural exercises but served well-defined purposes, one of the most important being to develop, adopt and diffuse best practice methods plant-wide. Aggressive performance demands provided the impetus, the presence and participation of the support staff (engineers, etc.), the opportunity to elaborate and spread best-practice procedures swiftly. As a part of this drive there was a very successful introduction of a plant-wide Kaizen programme in the autumn of 1992. The advanced team structure turned out to be ideally suited for sustaining continuous improvement activities. 'Previously', team members recalled during interviews in 1993, 'we had only felt the pressure from management to reach our targets. Now, we really got the support, and did a lot of things, often small improvements, we had never bothered to do before.'

Adler and Cole quite correctly emphasize that both concepts, both NUMMI and Uddevalla, are capable of learning and evolution. Nonetheless, they tend to interpret their impressions from the 1991 visit to Sweden in a very static way, as the essence of the Uddevalla concept.

'At Uddevalla', they write, 'work teams were left to their own devices. In the very early days of Uddevalla, managers gave workers the procedure documents from the Torslanda plant. But these procedures were not very well designed ... as a result, the Uddevalla workers quickly discarded them, and, along with them, the very idea of detailed methods and standards ... this management philosophy sounds more like abandonment than empowerment.' (Adler and Cole 1993:90). It is true that there was an interregnum at Uddevalla, when the traditional standards did not work and the new methods had not yet been developed. This interregnum was not an inherent feature of the Uddevalla concept, however. In fact, at the time when Adler and Cole visited the plant (mid-1991), this period was coming to a close, new pro-cedure documents had almost been completed and introduction in the assembly teams started.

The problem of finding effective means for diffusing methods and practices from high-performance teams to lesser performing units, that is, organizational learning, had been a management preoccupation since the start of the plant. Thus, Adler and Cole are wrong when they argue that a 'a third assumption built into the Uddevalla approach... is that an increase in individual learning automatically leads to an increase in organizational learning. This is a fundamental fallacy' (1993:92). Uddevalla had no problem in acknowledging the need for organizational learning, that was self-evident. The challenge was to organize it in effective and congenial ways. In 1991 and early 1992, the managerial answer was to strengthen the hierarchy and expand the role of the technical expertise. The new process-driven organization represented a very different solution, combining radical decentralization, participative management and strong performance orientation. The Kaizen programme was one approach to develop and diffuse best-practices. To further increase the process of knowledge transfer, the plant manager envisioned a comprehensive system of personnel exchange, within and between assembly shops, and eventually between the assembly department and the materials handling. According to managers interviewed as part of my evaluation study, it was only in 1992, three years after its inauguration, that Uddevalla had acquired an overall organizational form that fitted the team structure and production design. As the plant's former personnel head, a shop manager in the new organization, pointed out in an interview in April, 1993:

We had to learn so many things from scratch, starting with a process of un-learning, getting rid of previous conceptions and behavior. Only in

September 1992 we found an organization suited to our production concept. We also introduced a new programme for leadership development, which was essential for all shop managers, and the new management board. The first session of the programme took place in November, on the same day as the close-down decision was announced.

For all those interested in the development of competitive humanistic manufacturing, the shut-down of Uddevalla is a sad and disheartening event, but the evaluation of the plant's performance is a consolation. This 'experiment' was not only a bold step in creating humane work, but a potential success in a wide range of performance measures. Rapidly improving productivity and quality was combined with superior flexibility, low cost tooling, unparalleled customer orientation and a unique responsiveness to market demands. Volvo has abdicated from its pioneering position, but the invaluable experience is there for anyone interested in making use of it.

Note

1. Some of the arguments have been presented elsewhere (see Berggren, 1993 a; Berggren and Rehder, 1993). These contributions were based on a preliminary evaluation, whereas this chapter draws on the comprehensive assessment of Uddevalla and Kalmar presented in September 1993 (Berggren, 1993b).

References

- Adler, Paul (1992), 'The "Learning Bureaucracy"'. New United Motor Manufacturing, Inc.' In Barry Staw and Larry Cummings (eds.), *Research in Organizational Behavior*, JAI Press, Greenwich, CT.
- (1993), 'Time-and-Motion Regained'. *Harvard Business Review*, January–February.
- Adler, Paul and Robert Cole (1993). 'A Tale of Two Plants'. *Sloan Management Review*, Spring 1993.
- Anonymous (1989), 'Volvo's radical new assembly plant: "The death of the assembly line"?' *Business Week* August 28.
- Anonymous (1992), 'En dumhet att lägga ned Volvo Uddevalla', *Arbetsmiljö* No. 13, p 5.
- Berggren, Christian (1992), *Alternatives to Lean Production. Work Organization in the Swedish Auto Industry*. Cornell ILR Press. Ithaca
- (1993a), Ende einer Traumfabrik, *Die Mitbestimmung*, No. 9
- (1993b), *Mästar prestationer eller mardrömsfabriker? En utvärdering av Volvos småskaliga monteringsfabriker i Uddevalla och Kalmar. (Excellence or disaster? An evaluation of Volvo's assembly plants in Uddevalla and Kalmar.)*, Royal Institute of Technology, Dept. of Work Science.
- Berggren, Christian and Robert Rehder (1993), 'Uddevalla and Saturn. The Quest for Competitive and Humanistic Organization.', Forthcoming in *The International Executive*.
- Chandler, Alfred (1990), *Scale and Scope. The Dynamics of Industrial Capitalism.*, The Belknap Press of Harvard University Press, Cambridge, Mass.
- Ekström, Brita-Lena (1993), 'Kolsvart år för bilbranschen', *Dagens Nyheter*, January 5.
- Ellegård, Kajsa, Tomas Engström and Lennart Nilsson (1991), *Reforming Industrial Work – Principles and Realities in the Planning of Volvo's Car Assembly Plant in Uddevalla.*, The Swedish Work Environment Fund, Stockholm.
- Engström, Tomas, Bertil Johansson and Lars Medbo, (1992), 'Materialflödesmönster och effektivitet vid serieproduktion – förutsättningar för utveckling av det svenska monteringsarbetet.', *Arbete människa miljö* nr 4, pp 197–208.
- Gyllenhammar, Pehr G (1973), *Jag tror på Sverige. (I believe in Sweden)*., Askild & Kärnekull, Örebro.
- Larsson, Gerhard (1992), 'Volvos överlevnad', *Dagens Industri*, October 9.
- (1992), 'Torslanda-fabriken upp i Europa-toppen', *Dagens Industri*, December 4.
- Mosén, Gunilla (1993), 'Miraklet i Uddevalla. Strax före beslutet nådde fabriken rekordresultat.', *Bohuslänningen*, January 19.
- New York Times* (1991), 'Edges Fray on Volvo's Brave New Humanistic World', July 7.
- Swedish Metal Workers' Union (1987), *Rewarding work.*, Stockholm.
- Womack, James P., Daniel T. Jones and Daniel Roos (1990), *The Machine that Changed the World.*, Rawson Associates/MacMillan, New York.

Assembly skills, process engineering and engineering design

An example from the Volvo Uddevalla plant

Henrik Blomgren and Bo Karlson

Introduction

This article discusses the skills possessed by car assembly personnel. More specifically, it concentrates on skills which are valuable as input for design engineers during the product development process.

We will argue that the skill of the assembly personnel in Uddevalla is valuable for the design engineers. This difference, inherent in the Uddevalla concept, provides a potential to improve the ease of assembly of the product, a potential which seems to be absent in a traditional assembly concept, like the one in the Torslanda plant.¹

1. An example: the fuel pipe of model 740²

An example of the kind of feed-back that the assemblers in the group based assembly concept in Uddevalla were able to provide Engineering design, is a modification of the fuel system that was introduced on the 1992 model of three of the 740-versions.

During production in the summer of 1991, the Uddevalla assemblers discovered a problem, namely, that one of the fuel pipes after being assembled would touch the plastic fuel tank, with the risk of subsequently rubbing a hole in it. When the matter was investigated by the design engineers, it turned out that neither the assemblers, nor the process engineers at the Torslanda plant were aware of this danger.

Both in Uddevalla and Torslanda, a few components were preassembled on the fuel tank before the whole unit was assembled in the car. Among these components was a short fuel pipe, which was later to be connected to a longer pipe which led the fuel from the tank to the engine. The longer pipe was assembled on the body of the car. The problem occurred when these two pipes were connected to each other. The coupling had to be securely

tightened in order to prevent leakage and the torque caused the short pipe to bend until it came to touch the surface of the tank. In order to avoid direct contact, the assemblers had to manually bend the pipe when the coupling had been tightened. This did not only mean that an additional operation had to be performed, but it also involved a risk for future cracks developing in the pipe.

One of Uddevalla's process engineers analysed the problem and worked out a temporary solution.³ The solution involved putting a rubber bushing around the pipe in order to prevent it from touching the tank. He sent the suggestion to the department for engineering change planning in Gothenburg.⁴ The problem was analysed, and among other things, the design engineers in Gothenburg contacted the assemblers in Torslanda. As was mentioned above, the answer they received was that they had not found a solution to the problem. Indeed, neither the process engineers, nor the assemblers had even discovered the problem.

After some persuasion, the process engineer convinced the design engineers from Gothenburg to visit the Uddevalla plant and investigate the problem on location. The problem was finally accepted and the proposed solution was immediately introduced on the remaining cars to be produced as 1991 models, that is, on both the vehicles assembled in Uddevalla and in Torslanda. For the 1992 model, the design of the coupling between the fuel pipes was modified and the problem was permanently solved.

Why was this problem discovered in Uddevalla but not in Torslanda? Due to the way the assembly work was organised and the division of individual tasks, it was considerably more likely to be discovered in Uddevalla than in Torslanda. In Uddevalla, one single person assembled the preassembled fuel tank in the car, assembled the fuel pipe to the body, and connected and tightened the coupling between the two pipes. This assembler immediately noticed what happened to the pipe on the fuel tank when the coupling was tightened. In Torslanda, the assembly process was divided into three separate tasks, performed by three different assemblers. One person preassembled the pipe on the tank. A second person assembled the fuel pipe to the body of the car; while a third person assembled the tank in the car and tightened the coupling between the two pipes. These operations were carried out at different stations of the assembly line and the third person did not notice what happened when the pipes were tightened. Indeed, he/she was not even instructed or encouraged to check the result of tasks carried out at other stations.⁵

It should be made clear that the intention here is not to argue that this problem might never have been discovered by an assembler at the Torslanda plant.⁶ The main point is instead that it was discovered in Uddevalla and not in Torslanda (or in any other plant). Since we will focus on the potential of

the Uddevalla system, this example provides a platform for a deeper discussion on the links between different assembly concepts and the product development process.

2. The need for design for assembly

The concepts of 'Design for assembly' (DFA) and 'Design for manufacturing' (DFM) have been widely discussed during the past years.⁷ Scholars as well as practitioners, seem to agree, that it is important and sometimes even crucial, that products are designed in a way that make them easy and inexpensive to assemble.

Fundamentally, much of the discussion about how to design products which are easy to assemble is framed as a question of managing interfaces, most commonly between the functions where the product is designed and the functions where it is manufactured and assembled. These interfaces are usually assumed to coincide with organisational boundaries between functional units, in our case engineering design (Gothenburg), process engineering (at Gothenburg, Uddevalla and Torslanda), process engineering (Uddevalla and Torslanda), and assembly (Uddevalla and Torslanda).

Now, let us return to the question raised earlier about why it is important to design a product, in this case a car, which is easy to assemble. According to Williams & Haslam (1992), as little as 15 per cent or less of the labour input in a car is accounted for by the three final manufacturing steps: welding, painting, and final assembly. Consequently, even less is accounted for by final assembly. Why, then is it interesting to put efforts into designing a car which is easy to assemble?

Clark & Fujimoto (1991), have shown that 'manufacturing productivity' correlates to both 'development productivity' and to short development lead times. In other words, a company which is strong in manufacturing and assembly also tends to develop cars cheaply and rapidly. Studies at Volvo Car (Nermo, 1990; Karlson, 1992), and elsewhere (Aniander & Blomgren, 1989; Karlson, 1989, 1993:b), have demonstrated that late engineering changes can be very costly, that is, for example if the car can be designed correctly from the beginning, both time and effort will be saved. To return to the example, if the potential problem with the fuel pipe had been discovered during the design stage, it would have been cheaper to correct and it would have created less of a disturbance for the parties involved.

3. Engineering design at Volvo Car

The most common way, at Volvo Car and in general, to develop a product which is easy to assemble, is to find ways to feed back knowledge about the

assembly process to the design engineers during the product development process. This knowledge is traditionally provided by process engineering and sometimes, actually rarely according to our experience, from assembly personnel directly. However, the example shows that there is, in the Uddevalla system, a potential to provide the design engineers with better feed-back directly from the assemblers.

The normal feed-back channel when an assembler discovers a way to improve the product design is to request an engineering change. As was illustrated in the fuel pipe example, this process is formalized, which means that the assembler, most commonly through his superior, sends the request to the plant's department for process engineering. The request is then analysed and transmitted to a department in Gothenburg (engineering change planning) where the request is administered. Through this function, the engineering design department, the process engineers located in Gothenburg, styling and other manufacturing plants etc., become involved in the process of change. The request is checked from a number of perspectives, not least by other plants where the same vehicle is produced. An engineering change has to be accepted by all the parties involved, before it is implemented (see figure 1).

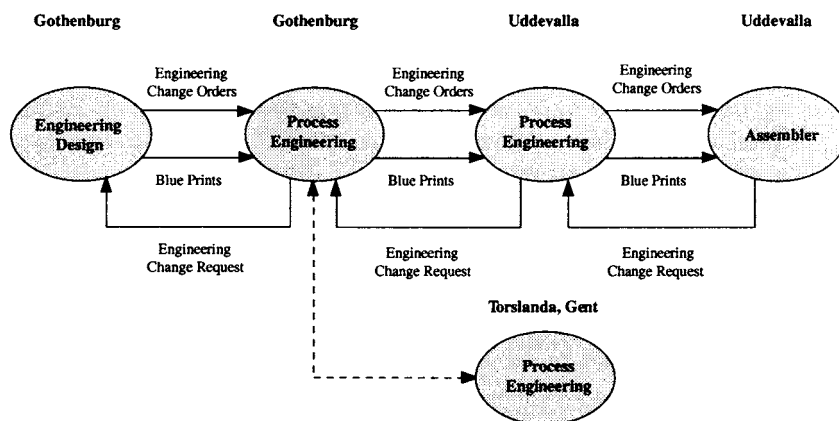

Figure 1. Formal communication channels at Volvo car

This mode of coordination is mainly used 'after the fact', for example, to correct errors, to improve the product design, or to improve the assembly process. Of course, many activities are also carried out during the process of developing a new product. Normally however, the assemblers do not take part at these early stages.

During the product development process at Volvo Car, special groups are created to facilitate the coordination of the various functional specialists involved in developing the different systems of the car.⁸ These multi-functional groups are usually managed by the head of the engineering design department responsible for the system in question. The group meets regularly during the development process and usually consists of personnel from engineering design, styling, procurement, process engineering, and assembly. The assembly plants are usually represented by one of the process engineers located in Gothenburg, not by an assembler or a process engineer from one of the plants. Before a new component or system can be released, it has to be approved by the departments involved.

Every new car and yearly model of an older car is produced in at least one try-out-run in the plant where it is going to be assembled. In Uddevalla, one experienced assembler from each assembly group is selected to participate in a 'pre-try-out-run' of the new model, after which they actively participate in working out the assembly instructions to be used by their colleagues when full scale production begins. At the Torslanda plant, a similar role is played by half a dozen experienced assemblers who represent the whole line. The difference is that the Uddevalla assemblers have more experience in working with the complete vehicle than their colleagues in Torslanda.

During the try-out-run, the assemblers are expected to point out those components which are difficult, or indeed, impossible to assemble. This is however, really the first time that they are given the opportunity to provide constructive feed-back on the product design.

The conflicting demands made from all the specialised functions involved in designing a car are probably especially accentuated when two different assembly concepts are used side by side in the same company, like in the Uddevalla and Torslanda plants. Most certainly, the demands on the design put forward by the different assembly plants differ from each other. What is efficient in Uddevalla might not be efficient in Torslanda. The issue is further complicated by the difference in relative importance between the plants. Since the Uddevalla plant was much smaller than the Torslanda plant, one might expect that the demands put forward by the personnel at Torslanda would carry more weight. To fully utilize a particular assembly concept, the car should be designed with that in mind. In Volvo's case, this would have been a crucial challenge in order to fully utilize the Uddevalla concept.

4. Assembly work and skills: differences between Uddevalla and Torslanda

It might seem obvious that the type of work experience a person possesses, mirrors the task he or she is performing.⁹ Different tasks give different ex-

periences and hence different skills. This, however, highlights a problem. With different experiences, based on performing different tasks, different perceptions of which problems are important and how these should be solved are formed. In other words, different perspectives are developed.¹⁰ A design engineer for example, views the world as composed of design problems while, the assembler views it as assembly problems. Karlson (1993:a), discusses among other things, differences in skills, status, and focus of the work between a design engineer and a process engineer at Volvo Car. We might even go as far as to say that they have developed different languages. This is the fundamental reason why it is important for design engineers to learn from the skills of the assemblers.

When saying that it is important that the design engineers cooperate with the assembly personnel, it is implicitly assumed that the right to identify and formulate the problems, at least in part, is moved from the designers to the assemblers. This is of course, not a trivial problem and if this privilege was moved, assuming that it would be possible, conflicts most certainly would arise.

The simple fact that different types of work, results in different types of experiences poses an interesting question. The assembly work at the Uddevalla plant is unique in the sense that, the individual assemblers work with whole vehicles, or at least with large parts of the vehicles. As the fuel pipe example shows, the assemblers in Uddevalla possess skills which their colleagues in Gothenburg lack. However, it probably would be assuming too much to say that they possess all the skills that the 'part vehicle assemblers' possess.

The following 'theoretical' example illustrates that assemblers who perform different tasks can provide different feed-back to engineering design. It is 'theoretical' in the sense that, it is designed in order to illustrate the differences in skills between the assemblers in Uddevalla and the assemblers in Torslanda. Of course, this is not to say that it is unrealistic.

Let us imagine two assemblers, one in Torslanda and one in Uddevalla. Both of whom assembles a specific component in the car, for example, a door or the dashboard. The Torslanda assembler repeats his or her specific task, approximately 100 times every day, since this is the only task he or she performs. The colleague in Uddevalla performs the task only six times every day because this task is only a small part of assembling the whole vehicle. It is probably very disturbing for the Torslanda assembler if, let us say, six different types of screws are needed to assemble the component, since this involves changing screwdriver or bit hundreds of times every day. The assembler in Uddevalla repeats the same task so seldom that he or she probably is more inclined to accept that half a dozen different screws are needed for that particular component. At the same time, an assembler

in Uddevalla is able to notice how many different types of screws are used in the whole vehicle. This is impossible for an assembler at the line in Torslanda. In order to get this information, every single assembly station has to be analysed.

To sum up, the example shows that the information that can be provided to the design engineers from the assemblers in the two plants, is likely to be different. In Torslanda, the assembler focuses on specific details of the vehicle whereas, the Uddevalla assembler focuses on the vehicle as a whole.

5. Conclusions

There is a difference between the assembly concepts in Uddevalla and Torslanda, which creates a difference in the skills that the assemblers in the two plants possess. More specifically, the fuel pipe example shows that the Uddevalla assemblers discovered a problem that their colleagues in Torslanda did not, and they were able to provide engineering design with information to correct it. Thus, both the ease of assembly and the function of the car were improved.

Our example indicates that some of the tasks traditionally performed by process engineers were performed by the assemblers in the Uddevalla plant. For example they actively worked with finding ways to improve the assembly process. This task is mainly performed by process engineers in Torslanda, which partly explains why this problem was discovered in Uddevalla but not in Torslanda. The focus of this article was on the skills possessed by assemblers. It seems clear however, that the two assembly concepts create a need for process engineers with two different sets of skills.

The fuel pipe example, indicates that the information that assemblers can provide to engineering design is important. In this case, the information was provided 'after the fact', that is, when regular assembly was running in Uddevalla. An interesting topic is whether it also means that information from the assemblers is valuable to engineering design during the product development process and if this varies between different assembly concepts. We believe that this is the case. We also believe that this potential, inherent in the Uddevalla concept, never was fully realized.

A longer version of this article is published in a series of papers at the Department of Industrial Economics & Management, Royal Institute of Technology, Stockholm October, 1993.

Notes

- 1 . The article does not describe, neither Volvo Car, nor the Uddevalla plant in detail. Volvo and the Swedish automotive industry have been described in detail in Berggren (1990). The development of the Uddevalla plant is thoroughly discussed in Ellegård (1989).
- 2 . Model 740, the cheaper of the two cars in the 700 family, was introduced in 1984. The 700 family was gradually replaced by the more expensive 900 family and model 1992 was the last 740 model produced. In 1991, 47,800 740s were produced of which 3,000 were assembled in Uddevalla, 1,000 in Torslanda (Gothenburg), and 41,400 in Gent (Belgium). The rest were assembled in Halifax (Canada), Indonesia, and Malaysia. In the same year, the total amount of cars assembled in Uddevalla was 19,100, in Torslanda 73,900, and in Gent 69,500. (Source: Official statistics provided by Volvo's Information department.)
- 3 . There are two kinds of process engineers at Volvo Car, one group located at the head-quarters in Gothenburg and one group located at each of the assembly plants. These groups are organisationally as well as physically separated. The process engineers in Gothenburg are responsible for making sure that new components and systems are easy to manufacture and assemble. They cooperate extensively with the design engineers. The process engineers at the plants, usually a relatively small number, are responsible for manufacturing and assembly equipment, production planning and methods, and to some extent to make sure that the components and systems can be easily and cheaply manufactured and assembled.
- 4 . This is an administrative function which, among other things, handles the administrative work involved in making design changes.
- 5 . The fuel pipe example deals with Uddevalla and Torslanda. However, since the majority of the 740s produced in 1991 were assembled in Gent, it should be pointed out that this specific problem was not discovered in Gent either. Indeed, when the process engineers in Gent were asked to comment on the suggestion from Uddevalla, they gave the same answer as the process engineers at Torslanda. Consequently, the same argument can be made for the plant in Gent, even though this has not been specifically investigated.
- 6 . This is actually an example of a philosophical issue, discussed for example by the philosopher Karl Popper.
- 7 . See for example, Womack, Jones & Roos (1990), Clark & Fujimoto (1991), and Susman (1992). It is also worth noting that the discussion is not new. An example of a much older discussion of the same topic is found in Hesselman (1948). The author, a very successful Swedish engineer, writes about the improvement of the Diesel engine during the first decades of this century. On many occasions in the book, he points out the importance of designing the product so that it is easy and cheap to manufacture.

- 8 . So called 'Process groups' or 'Beredningsgrupper' in using Volvo terminology.
- 9 . This is thoroughly discussed by Göranson (1992).
- 10 . The concept of perspectives is thoroughly discussed in Danielsson (1983).

References

- Aniander, Magnus and Henrik Blomgren (1989), *Minskad ändringsvolym – Atlas Copco MCT*, M. Sc. Thesis, Department of Industrial Economics & Management, Royal Institute of Technology, Stockholm
- Berggren, Christian (1990), *Det nya bilarbetet, Konkurrensen mellan olika produktionskoncept i svensk bilindustri 1970–1990*, Arkiv avhandlingsserie, Lund
- Clark, Kim B. and Takahiro Fujimoto (1991), *Product Development Performance: Strategy, Organization, and Management in the World Auto Industry*, Harvard Business School Press, Boston
- Danielsson, Albert (1983), *Företagsekonomi – en översikt*, Studentlitteratur, Lund
- Ellegård, Kajsa (1989), *Akrobatik i tidens väv*, Department of Human and Economic Geography, School of Economics and Legal Science, University of Gothenburg, Gothenburg
- Göranson, Bo (1992), *The Practical Intellect: Computers and Skills*, Springer-Verlag, London
- Hesselman, Jonas (1948), *Teknik och Tanke*, Sohlmans, Stockholm
- Karlson, Bo (1993 a), 'Teoretikern möter praktikern: Yrkeskunnande hos konstruktörer och beredare', *Dialoger*, nr. 27–28, August
- (1993 b), *Ritningsändringar – orsaker, konsekvenser och åtgärder*, Association of Swedish Engineering Industries, Faktarapport Konstruktion nr. 2, August
- (1992), *Rätt eller Fel? En studie av konstruktionsarbete på Volvo PV*, Department of Industrial Economics & Management, Royal Institute of Technology, Stockholm
- (1989), 'Consequences of Errors During the Process of Product Design and Development: Three Case Studies from the Swedish Engineering Industry', Proceedings from *NORD-NET 89*, Nordic Congress on Quality and Project Management, Imatra
- Nermo, Anders (1990), *Orsaker till sena ritningsändringar under produktframtagning, Fallstudie utförd på Volvo PV*, Department of Industrial Economics & Management, Royal Institute of Technology, Stockholm
- Susman, Gerald I. (1992), *Integrating Design and Manufacturing for Competitive Advantage*, Oxford University Press, Oxford
- Williams, Karel and Colin Haslam (1992), 'Against Lean Production', *Economy and Society*, August
- Womack, James P., Daniel T. Jones and Daniel Roos, (1990) *The Machine that Changed the World*, Rawson Ass., New York

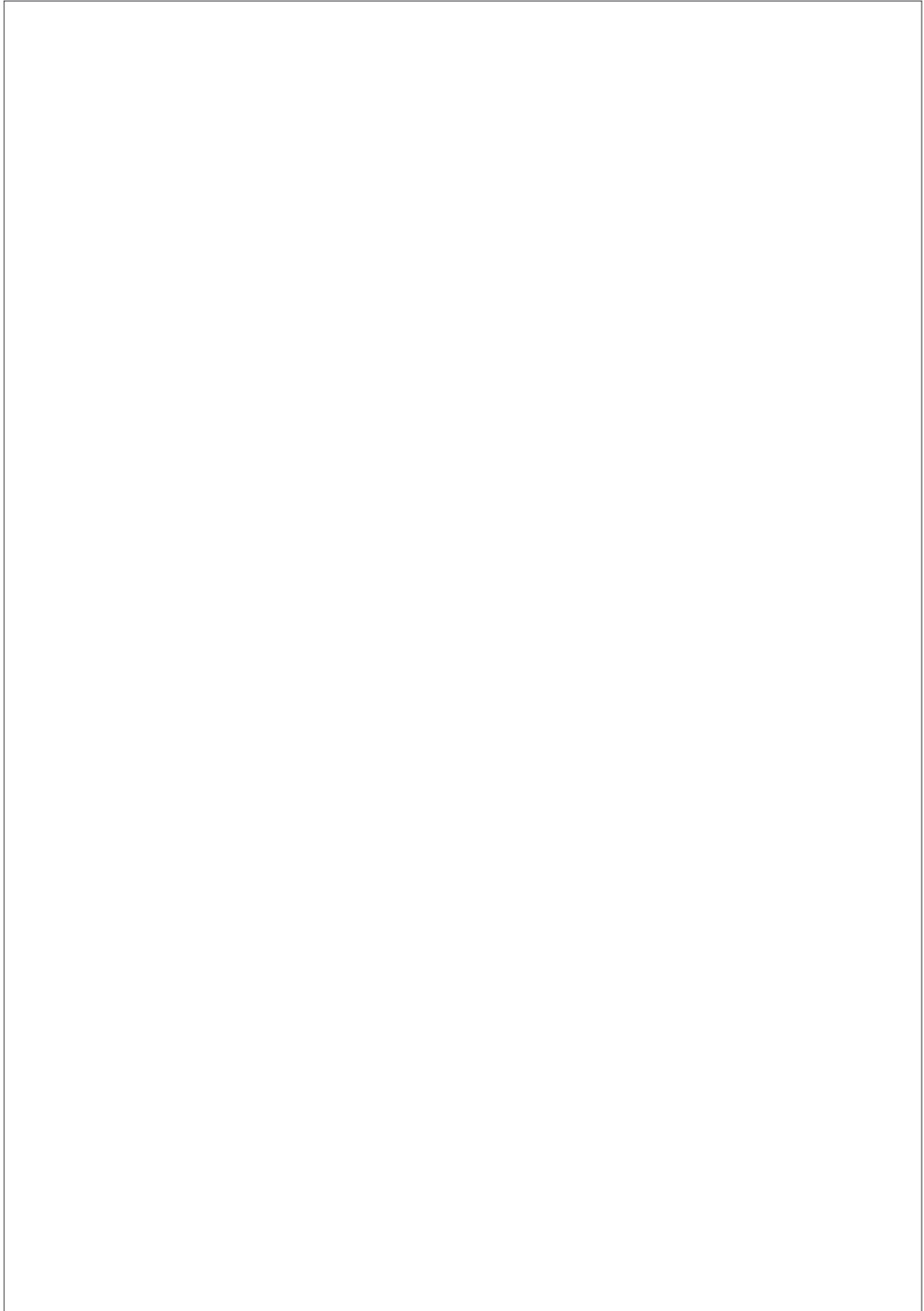

Building for new production concepts

Colin Clipson, Jesper Steen, Anders Törnqvist & Peter Ullmark

The Kalmar and Uddevalla buildings have been used consciously and effectively as symbols of Volvo's new production concepts. Pictures showing the distinct hexagon form of Kalmar and the clover-leaf pavilions in Uddevalla have been spread over the world to illustrate Volvo's ambitions. Now the pictures have been used again to convey the sad message that those pioneer industrial plants have been closed down.

What can we learn from these plants? Did the buildings as such contribute to the realization of new production concepts? What is the relationship between functional and symbolic values? How important are buildings in industrial production?

The language of buildings

Corporate buildings always tell us something about the company. Intentionally or not, they reflect how the employer regards his employees and the work they do. Distinct architectural forms and durable materials also testify to the aesthetic and cultural ambitions of the client. Anonymous, budget-priced sheds make a corresponding statement in that respect. Usually architectural quality and intentional corporate symbolism are reserved for headquarters and other important office buildings. Expressing a positive and clear company philosophy in buildings for industrial production is not very common. And perhaps not very easy either.

When Gunter and Margaret Blase approached the young and prominent British architect Nicholas Grimshaw to design a factory for their family business, Icus GmbH, they described their company as a solar system; the centre of the company's sphere of operation should be the client (the sun), while company departments (planets) should revolve directly around the clients. Department managers (moons) may be close to the department as the situation demands, and the managing director (comet) passes by everyone,

maintaining a close relationship with all. Grimshaw and Partners designed a skilfully crafted, refined product; a clear, square span of 33.75 meters in both directions with the roof suspended from vertical braced tubular masts. This flexible, interchangeable factory/office space does not give any clues to the expressed company philosophy. The task of translating the private culture of the enterprise, the public culture of the workplace and reconciling them with a responsibility to the rest of the synthetic and natural world is not an easy one. Perhaps the architect in reality had few options other than emphasizing the need for flexibility above all.

Were the Kalmar and Uddevalla factories too special?

In the Volvo case, the unusual forms of the Kalmar and the Uddevalla factories were specifically chosen to demonstrate that working methods in these buildings were unique. One reason for the unions to support the layout of the Uddevalla plant was reportedly that it made it impossible to reintroduce the mechanical assembly line. Everybody involved in the two projects seemed to agree that the new buildings were important for the realization of the production concepts.

Even without the complications of strong demands for flexibility, the best design for an industrial building is not obvious. Functional requirements can be met in several ways, there are choices regarding the proper symbolic expression of the building. There are sometimes difficult contradictory demands to handle. When investing in a new production plant, there is the need on one hand to emphasize the benefits that a new, different and efficient design will give. This is necessary to justify the expenditure of time, money and energy that the change will require. On the other hand there must be in many cases a possibility to see the continuity between the old and the new in order to build consensus and team spirit. Everyone involved should have a chance to find support in the new design for his or her particular values and ambitions.

The current planning and design process, dominated by a technical rationality, has problems in handling these contradictions. The technical rationality, according to Schön (1983), separates planning from use, management from execution of work tasks, thinking from doing and theory from practice. A tacit assumption is that it is in fact possible to design systems that will work exactly as the designers, planners and systems engineers, have intended. But small attention is usually given to how future users will conceive the system and to the possibilities to use it in ways other than those planned for. Inevitable starting-up and running-in problems are witness to this. In some cases a lack of fit between goals and performance also gives the system unforeseen adaptability.

In this perspective, flexibility could be used by the employees to find their own solutions and continue to develop the production system. Flexibility of the total production system could be a conscious corporate strategy, not only a way to handle uncertainty caused by technical advances and the vagaries of the market place. Buildings with a usually long-life and great degree of freedom as technical systems are a good illustration of how more robust artefacts can be designed. Some lessons could perhaps be learned from building design that could be applied to the general problems of designing organizations and large production systems.

The Kalmar and Uddevalla cases give unique possibilities to discuss this classic dilemma of efficiency in the short term versus adaptability in the long term. To what extent did the special building design of these plants successfully express, promote and establish the new production concepts? How did the buildings make 'good work' possible? In Uddevalla there was an effort to avoid rigid technical systems with heavy mechanical equipment, which would hamper future development. But was this effort matched by the final building design? Is there a risk that the design was too specialized, too tied functionally and symbolically to a particular production system to survive a changing corporate environment? Is a new type of design process needed?

Innovative form and production change in the Kalmar factory

The Kalmar factory was built in 1974 after a dramatic development process. The recently appointed President Pehr G Gyllenhammar rejected the first plans. In just a few weeks a radically new alternative was developed by the 'Ultra' group.

According to this new, distinct vision, the factory was divided into small workshops with teams of 15–20 people taking care of 4–5 assembly stations along the line. Each team had their own foreman and their own entrance, lockerrooms and coffee lounges. The teams should function as small enterprises, competing with each other to improve productivity and quality. Automated carriers, controlled by a central computer system, permitted this kind of work organization as well as a more flexible layout.

This opened up new ways of organizing the building. The traditional rectangular hall was neither necessary nor appropriate. The demand for natural lighting along the assembly-lines, together with the large volume of assembly parts to be supplied, gave rise to the hexagonal form of the buildings. The hexagon affords greater area and circumference in relation to the distance to the centre, compared to a square or a rectangle. Two assembly levels wrapped around the central storage area, serviced by high reaching



Figure 1. The Volvo Kalmar factory

fork-lift trucks, produced a concentrated and efficient layout. As a form found in beehives and other natural phenomena, the hexagon strongly conveys an impression of busy work and efficient use of materials.

The assembly-team areas along the outer walls are both well-lit and human in scale. By means of the angled walls, with the office and service areas at the pivotal corner, the architect has succeeded in skilfully solving the conflicting demands for both separation and contact between different work teams. (Fig 2) The service units projecting from the main face of the building contain the staff entrances, foremen's offices, locker rooms and coffee lounges for each assembly team. They embody important features of the work organization.

The strong symbolic effect is obvious when looking at the often published aerial photos. But from a close range the building looks much like an ordinary industrial building. The building volumes as such are bluntly planted on the vast, flat ground. A small fringe of greenery at the building perimeter is not quite enough to give a human scale to the important sector where building meets site. Taking his cue from Habermas' distinction between purposeful rational action and symbolic interaction, the architectural critic Kenneth Frampton wrote in his analysis of the Volvo plants (1976):

The disproportion of emphasis accorded to these two forms of rationalisation in advanced industrial society finds its direct reflection in the built environment as a whole and while at Kalmar the team work-shop func-

tions adequately for free discourse within the limited ground provided by the technostructure, the somewhat restricted personnel or coffee break rooms on the perimeter of the building, far from serving as avenue for symbolic interaction are clearly only intended to function, like the saunas in the wash-rooms, to restore the will to work. It is surely no accident that these rooms are inadequately represented in architectural terms, both inside and out, and that their windows open not to pleasure gardens but to the industrial amnesiac landscape of the megalopolitan strip, that no man's land of boring commutation by automobile that even here Europe all too often serves to suspend the worker in time and space between the reality of industrial production and the compensatory pleasures of the suburban home.

According to Gerhard Goehle, the architect who planned and designed the factory together with the late Owe V. Svärd, there was originally no plan for a physical extension. Expansion was to take place by means of doubling the work shifts. In 1987, however, a steadily increasing number of parts to be assembled forced an extension by a fourth hexagon. It has also been difficult to keep team-areas within the length of each edge in the hexagon and the clear correspondence between work organization and physical form has been muddled.

As in all multi-faceted symmetrical buildings, orientation is something of a problem. The different team areas gain their individual identity from the parts being assembled – wheels, seats, dashboards. It should also be mentioned that some ground floor assembly-team areas for the preassembly of chassis parts are less well defined and have no contact with daylight. People working at Kalmar have witnessed that they often feel 'just like a little cog in an anonymous machinery'. As Kenneth Frampton (1976) pointed out, the panoptic aspects of the production shed have been replaced by a computerized production system as a far more efficient control mechanism. Just as the small angular deviations of the exterior walls must ultimately add up to the exact hexagonal form, the flexible work cycle and the varying production buffers must also in the end produce a prescribed number of faultlessly assembled cars.

Saturn – an American example of sociotechnical production

In the United States, the Saturn company (now producing a highly successful, high quality automobile), stands out as one example of an enterprise influenced from its very beginning by the Swedish sociotechnical model. In the 1980s, the dramatic business decline of General Motors forced its board and shareholders to plan a new and separate manufacturing and assembly organization, with a new approach to the planning of work organization,

a new car design, a new company name, and a location far away from the traditional core of automotive production: Detroit.

In many ways the Saturn operation and complex is an example of American pragmatism and know-how at its best. Early research and planning of the new enterprise closely followed the most successful production concepts from both Europe and Japan, as well as North America. Benchmarking studies identified key companies and their production strategies: Toyota, Honda, Volvo, Mercedes, Ford, Nissan and so on. Working within the confines of a stifling bureaucracy and tradition, it is surprising that the Saturn concept of teams and semi-autonomous business groups pulled as far away from the parent company as it did. Not as far away as Uddevalla from Torslanda in Gothenburg, but nevertheless, a definite break with the tradition was made.

Early benchmarking studies by Saturn clearly document the influence of Volvo on Saturn's development of self-directed teams, team centred work layouts, training, and team and group facilities. The plant itself is architecturally bland but configured with what Kenneth Frampton (1976) has called 'compensatory spaces and amenities': restaurants with access to the outdoors, a fitness centre, family centre. Set in a green-field rural site, the Springhill plant houses its diverse functions in a series of low profile blue, grey and terracotta sheds, well landscaped and almost out of sight to passing highway motorists; the absolute antithesis of the Ypsilanti or Sterling Heights assembly plants or the factories of the Rouge River in Detroit. Evidently there has been a clear ambition to express the various socio-technical features of the production plant, training centres as well as compensatory spaces, and articulate its relations with the physical and social environment in a sensitive way. In these respects the Saturn complex seems to represent a development when compared with the compact and closed Kalmar factory, bluntly placed on a flat and tarmac-covered industrial site.

International star architect designed the Uddevalla plant

With the Uddevalla assembly plant, Volvo took a decisive step further in developing assembly methods. Compared with Kalmar the teams are smaller and more independent of each other and consequently, there has been less need to integrate the workshops into a single building.

Volvo's decision to let American architect Romaldo Giurgola design the new Uddevalla factory had symbolic significance. Giurgola had designed the luxurious new headquarters for the Volvo group in Gothenburg a few years earlier. Volvo's CEO, Pehr Gyllenhammar apparently wanted assembly workers to enjoy an environment of comparable quality.

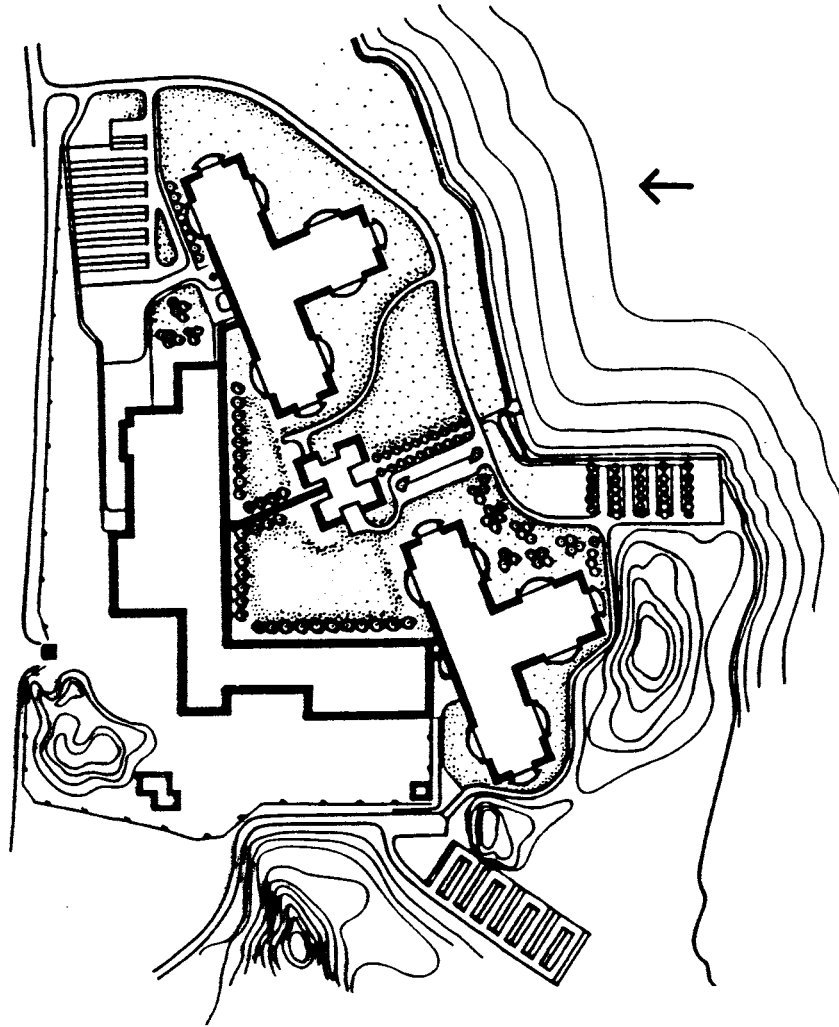

Figure 2. Master Plan of the Uddevalla Factory

In spite of architectural qualities still rare in industry, the result was open to critical discussion. The layout of the buildings clearly and elegantly displayed the new work organization with car building teams in separate production workshops. (Fig 2) The workshops provided a pleasant work environment but over time have proved to be somewhat too small. Because

of the strong visual form, there seemed to be few possibilities for change and extension. Closer scrutiny revealed interesting but dubious architectural statements.

The symmetrical administrative building had a prominent central position, suggesting an Italian villa in the midst of surrounding agricultural buildings of larger and less elaborate volumes. The building could be seen as a potential meeting place for several actors involved in future automobile production, including customers, marketing experts and production employees, but at the time this strong expression of hierarchy seemed overstated. Production was in fact mainly controlled from Gothenburg. The interior of the administrative building was much less pretentious than the exterior, almost egalitarian, with small, uniform office cubicles for all white-collar personnel, including the local manager. Of course, there was still real distance, physically and socially, between the local administration and the production. A computerized production system made both distance and control possible.

Physical and organizational distance existed also between the assembly workshops and the materials centre in an existing, large L-shaped building, acting as a dark blue backdrop for the low workshops buildings. In the materials centre preassembly and kitting of parts for each car took place, a less demanding and more monotonous work than assembling at least one fourth of the car. Through the computer systems the assembly teams coordinated material flow, therefore making social contact between the two types of work-teams neither necessary nor facilitated.

In a recent evaluation of the Kalmar and Uddevalla plants by Berggren (1993), these critical observations have received striking confirmation. Berggren describes the radical organization changes initiated in September 1992 to further develop the potential of the new production system. Middle management was reduced and engineers and top level managers worked directly with the teams out in the workshops, themselves trying their hand at assembly work for short periods. A final step, that of emptying the administration building completely and moving the management to the materials centre unfortunately was not made, because of the closing-down decision, but would have been the logical conclusion of a very promising development. The responsible manager, Peder Elison, remarked: 'At first there was no big discussion, probably because some people thought I was not serious. But as soon as we had established an office in the materials centre I would have been the first to move out. And the others would have followed. I don't understand how one could build a plant like this. Aesthetics dominated completely over function.'

The formalistic layout of the Volvo Uddevalla plant led to further inequalities. Many of the 'combines', apse-like protuberances, containing the office and recreation areas of the work teams, enjoyed a sea view, but because

of the symmetrical plan some teams looked out on parking lots and cliff walls. Landscaping did not improve the qualities of the site. In this harsh coastal climate the need is greater for protective mouldings and barriers than for flat lawns and straight lines of trees connecting the shore with the office entrance. No outdoor recreational spaces adjacent to the workshops were provided.

However, in view of later events a more important question is whether the formalistic, symmetrical plan could have made future changes and adaptations more difficult, functionally and symbolically.

In search of the flexible factory

At present we work in a world where two forms of manufacturing are rivals – ‘where elements of Henry Ford production and Peter Faberge craftsmanship coexist’, as a writer in *The Economist* expressed it. Automation is driven further at the same time as dependence increases on the skills and personal responsibility of autonomous work-teams. Manufacturing facilities must provide work environments that fulfil both human needs, the need for technical change and development of the work organization. The large, all-purpose production shed has serious problems from an environmental point of view, problems that are ominous in a situation where production is becoming increasingly dependant on workers’ skill, commitment and versatility. The tailor-made factory, formed around a specific production concept is not an alternative when fluctuating market demands and stiff competition make flexibility, automation and new forms of work organization imperative.

It is clear that the turbulent economies and social climates of today (and tomorrow) can best be addressed through flexible organizational behaviors, supported by those tools and production facilities that are themselves adaptive to change and turbulent conditions. Kalmar and Uddevalla were designed to provide adaptive workplace conditions for the new ways of working developed at Volvo for more than twenty years. Over that period of time Volvo made steady, incremental departures from its traditional ways of assembling at Torslanda. Over an even longer period of time, Japanese companies were gradually/incrementally perfecting the just-in-time and lean production approach to manufacturing.

The spatial cultures of Kalmar and Uddevalla represent the two milestones in Volvo’s development of its flexible process of automobile production. In principle, both facilities provide the process, tools, materials handling and inventory systems to make other kinds of consumer products. In the case of Uddevalla, the vast sheds of the materials workshop and its computer system, the geographically separated product assembly workshops, each

with 80–100 skilled workers, provide small group assembly potentials that could be developed.

It may be that in its own way, Uddevalla is more adaptive to the demands of changing market forces than the parent company and its strategic planners and market researchers. Of the two facilities, perhaps Uddevalla offers more possibilities for production alternatives because of its more distributed, radiating plan, compared with Kalmar's closed hexagons. On the other hand, Uddevalla's site and 'customized' configuration places limitations on reuse as a traditional assembly plant. Physical and social distances have also proved to be a disadvantage of the Uddevalla layout. It could be possible, however, to extend the potentials of production flexibility, not only to varied product lines, but also to occupancy by multiple owners and small companies or incubators. This is not the case with Kalmar, or some of the single umbrella or shed designs of the conventional production facility, despite the process line flexibility these may offer in their uninterrupted floor space.

In its relatively short life span, Uddevalla has demonstrated a new way of working, with the radical and primary objective of building the whole car. Earlier experimentation with team built subassemblies at Kalmar made the later development comprehensible and feasible. Yet one may ask, did the Volvo company go far enough in its own strategic thinking about the global marketplace and competition that it would face in the 1990s? Slow to react to the new product needs of the marketplace and slow to adapt to volatile business conditions, Volvo now finds itself reverting to a more traditional form of production. Why? A loss of corporate nerve? Powerful outside influence and events? A fear of having gone too far in its pioneering new ways of manufacturing?

Just how flexible and how broad in function the factory of the future must be, has been outlined by Chase and Garvin (1989) in their article *The Service Factory*. Flexible factories offer flexible and changing services and are adaptive to new customers' needs. These factories offer customers timely feedback on the manufacturing of new products; they produce prototypes rapidly, and involve customers in evaluating new products. Factories of the new kind often act as demonstration devices that promote new and more effective ways of making products, pulling potential customers into the factory and making them an important part of the process. This type of production facility can act as a laboratory for new ideas suggested by end users. Such a facility links up with the after market service and life of the product produced to make sure that changing needs are addressed.

3M Medical Electronics Systems Manufacturing Division is a current example of this type of factory. The 3M factory provides a full scale simulation complex and classrooms in the plant where surgical teams from hospitals around the country are invited to simulate and devise new types

of equipment for new procedures. 3M staff and customers codesign new products with medical professionals who take these new products back to the hospitals for trial. Staff and users watch and critique the codesigning from adjacent classrooms. 3M is a leader in adapting its manufacturing to meet its users' needs.

The service factory of the future involves all employees in generating high quality products. As Peter Drucker has pointed out, knowledge work in the factory of the future will allow workers to interact in all stages of product development from the design concept to the servicing the product in use.

Did Kalmar and Uddevalla, as the most progressive components of the Volvo culture have this potential? Perhaps. But not without more progressive product strategies and market know-how. Do such production cultures exist, or are they merely aspirations? According to Chase and Garvin (1989), many companies are on the way to realizing these potentials, namely Hewlett Packard, Allen Bradley and Caterpillar. It may well be that the most progressive cultures for such development are not to be found in the auto-mobile industry at all. In a study of over 200 factories by the IBM Consulting Group, researchers rated factories according to the best available international standards for such criteria as product quality, logistics and manufacturing, lean production and state of the art tools and facilities. Those scoring over 80% on the resulting scale were defined as world class. The best performing industries were those of electronics, information technologies and food manufacturing. The worst performers were those manufacturing automobiles and aerospace components.

There is little doubt that automobile industries around the world are at a critical stage in their evolution, of which the choices between modes of production, as well as the role of machines and the role of people are central issues. Uddevalla is closed at the precise moment when the Japanese manufacturers are seriously reconsidering the culture of their way of working, and the negative effects this work culture is having on the attitudes of Japan's younger generation.

Urban metaphors in factory design inspired by service industry buildings

In consequence with the trend toward more knowledge-based and customized production, it is no surprise that the first attempts to optimize social and technical needs were made in buildings for the service industries. Herman Hertzberger's Centraal Beheer in the Hague, Holland, built in 1974, houses the thousand employees of an insurance business. A top lit central street runs through stacks of pyramidal decks, each floor connected by bridges. Top down lighting, open decks and staircases, combined with lush interior

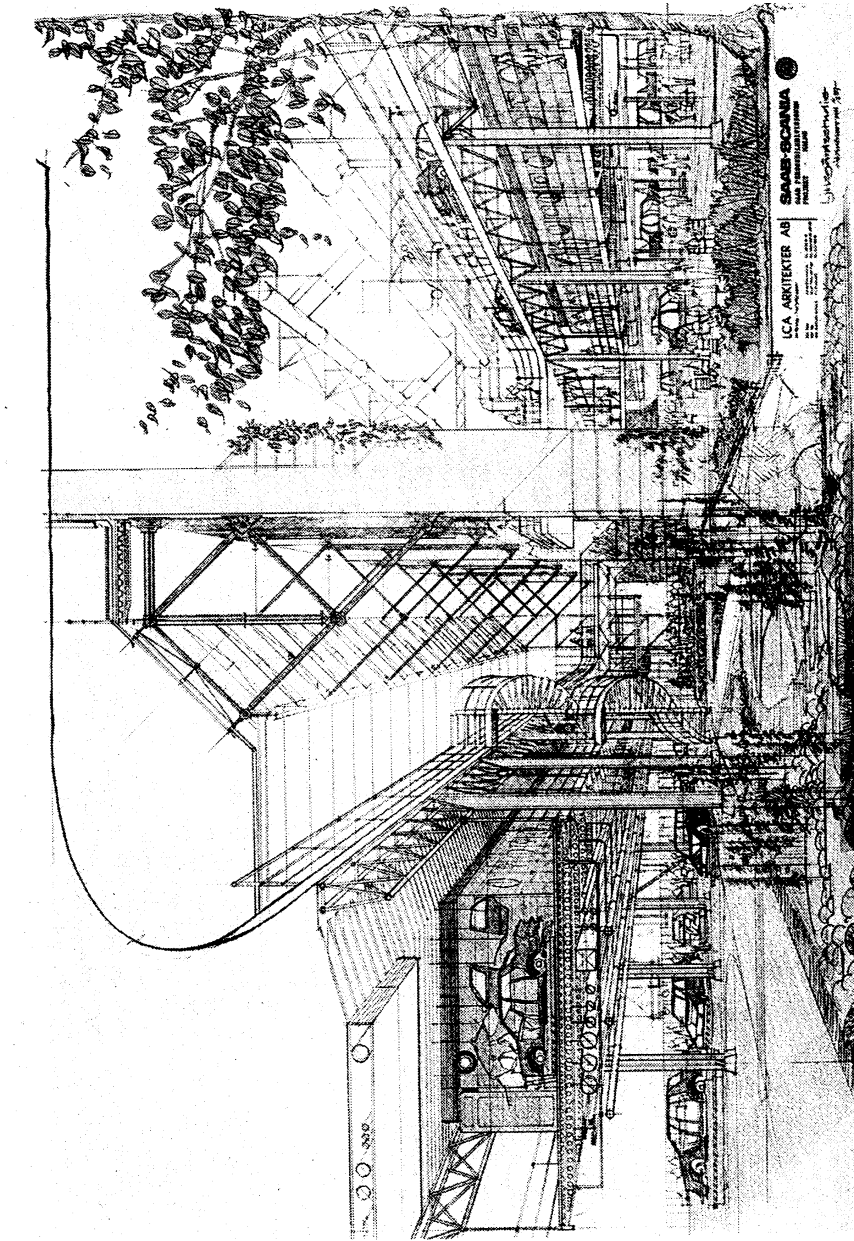

Figure 3. Perspective drawing of SAAB-Scania assembly plant in Malmö

vegetation of plants and trees, creates an indoor city with open air quality in the labyrinth of space. Perhaps its strongest break with the traditions of office and particularly the open plan office, was its sense of freedom to choose and move. The blend of work and social space were more reminiscent of an urban neighborhood than of a dedicated workspace.

Designed by Niels Torp in 1988, (though masterminded by the visionary SAS CEO Jan Carlzon) the SAS headquarters is one of the most wellknown examples of the workplace as urban form with its descending street lined with not only seven office floors, but cafés, cinema, shops, bank and swimming pool, in short, all the amenities of city life. Finally, in the recently built London Ark at the Hammersmith flyover in London, by Ralph Erskine, a British architect, (domiciled in Sweden), the town metaphor is pronounced again. Rising layers of offices and meeting spaces wrap around a lofty, spectacular atrium with restaurants, meeting lounges and bridges.

The urban metaphors could also be found in a new assembly plant, built in Malmö, by the other Swedish automaker, SAAB Scania. Not long after the Volvo Uddevalla factory was built in 1988, SAAB made a similar move and took over parts of an abandoned shipyard site in central Malmö. A huge building used for welding iron plates into sections of ships was converted into a modern car assembly plant. Like the Uddevalla plant it too was closed down after an even shorter period of operation. But it is interesting to compare the two plants from other viewpoints as well.

The interior central street, 250 metres long, 20 metres wide and 12 metres high, is the indisputable centre of the SAAB building. (Fig 3) As such it is surprisingly successful, in receiving generous natural light from several directions. Inspired by modern office buildings, notably the SAS airline headquarters in Stockholm, this street nevertheless has a distinct industrial flavour through the heavy roof constructions and thick bundles of technical installations freely penetrating the open space.

Through this central street an overview of the total plant is possible. The main entrance is used by everyone. Walking among hundreds of people choosing routes on different levels to reach their work area, it is possible to get an understanding of how their tasks all contribute to the common goal, that of producing a certain number of quality cars. The recreation spaces are not definitely assigned to a certain production area as in the Volvo Uddevalla factory. One can choose different routes to several areas.

The SAAB Malmö and the Volvo Uddevalla factories can be seen to illustrate different principles, which can be used to overcome the lack of meeting places in the traditional factory building. The labels to describe them could be called 'The Main Street' and 'The Family Flat'. In Uddevalla, Volvo chose 'The Family Flat' solution, where a team of car builders formed a socially tightly knit unit with their own distinct spaces for work and rest. This gave

identity and strength within the 'family' but also a risk of strong pressure to conform within the group and aloofness towards other groups. One got the impression that in Uddevalla, the assembly workers were the ones who actually built the car. The material handlers performed a less qualified and more monotonous service function. Those who started working there might not have gotten the natural contact with the assembly work and a chance later to try their hand at other tasks.

SAAB did not go as far as Volvo in letting the workers build the whole car. But the work cycle became considerably longer than the customary 2–3 minutes. Car builders and material handlers were part of a larger team and switched tasks to provide variety and broaden skills. The need for identity and contact was not met through a close-knit 'family' as in Volvo, but through the more varied social life of the factory street. But in spite of the large 'urban' scale, the public character of the SAAB street was limited. The foremen's offices were obtrusively juxtaposed with the recreation spaces, contact with the exterior natural and urban environment was obscured.

Is it really necessary to choose between the SAAB and Volvo solutions? Might it not be possible to have both the larger integrated groups and the challenge of building the whole car? Another physical configuration of the Volvo plant was discussed at an earlier stage. The production workshops were then placed as 'bubbles' around the Materials Centre. Perhaps that idea could have been developed further so as to integrate assembly work and materials handling. It would seem that evaluations of alternatives and possibilities of this kind need more developed concepts and tools of analysis.

Analysis of spatial cultures

A retrospective view might suggest that in the transition and course of industrial events, automobile production facilities have had to deal with both the maturation of mass production and the emergence of new forms of customization of products and flexible manufacturing. Much of this development has been in the hands and minds of production designers and technical innovators. Exploration of more progressive building forms has primarily originated in other industries – electronics, computers and communications.

Little research has been done on the dynamics of spatial cultures in workplaces. However, the work that has been done, by Hillier & Hanson (1984), Peponis (1985), and others, suggest that the design of space (e.g. for the factory) has strategic effects on the culture of workplaces. Some types of behavior are made possible, others impossible. Below the details of architectural styles and decorations there are spatial patterns established and controlled by the brief that the client gives the designer. It is aimed at

preserving existing patterns of power distribution and behavior (Markus 1993). Research to date suggests that there are basic concepts used in space syntax analysis which may lead to a more general understanding of the social properties of layout and in fact offer a more reliable way of comparing one layout design with another. As yet there are really no quantitative techniques for evaluating and comparing the social effects of different spatial layouts. In contrast a great deal of work exists on the technical layout of machinery and the effects of such layouts on assembly cycle times, materials handling and other production engineering issues. Perhaps this methodological imbalance as much as anything else, thwarts the attempts of the designer of interior space in factories to balance social with technical needs.

Concepts for a new design process

We have seen that in spite of strong architectural expression, which communicate both corporate ambition and new forms of work organization, both the Kalmar and Uddevalla factories suffer from weaknesses as building designs.

Physical demarcations, expressing autonomy for work teams, also help to structure the overall space and improve readability and understanding of the building as whole. But demarcations on the other hand can be excessive if they obfuscate coherencies and weaken the plant's social integration. In spite of the relatively small size of the Kalmar factory, its regular and symmetrical form, the dominant materials storage in the central part of the building and the separate entrances for the work teams, orientation and overview in the building are difficult.

In Uddevalla, the lack of overall coherency, despite a superficial architectural symmetry and elegance, is even more prominent and seems to have kept social integration of different personnel groups at a minimum.

Other deficiencies common to both plants concern the poor adaptation to the site and difficulties to extend and change the factory buildings while keeping the distinctive visual form of the original layout. In retrospect, it is easy to find fault with the basic architectural concepts. One could search for other design solutions that would reconcile conflicting requirements better. However, extreme time constraints and insufficient awareness of the necessary phases of the design process seem to be the primary reasons for the difficulties.

First it should be recognized that time constraints as such are not always inimical to creative design. On the contrary, as knowledge of the different aspects of a design problem increases, new and radically different concepts may develop late in the decision process, even if the financial and organizational constraints have tightened (Steen & Ullmark, 1992). The Kalmar

'Ultra' concept is an example of this. In spite of the short time, it seems that effective project management and a cooperative spirit between the parties involved ascertained that the basic requirements concerning the physical work environment were met, both in Kalmar and Uddevalla.

However, there seems to have been insufficient time and motivation for an important phase in the design process, where primary concepts and detailed design work are consolidated into a final product. (Lundqvist & Ulmark, 1993) In an introductory conceptual phase, primary design concepts, sometimes expressed in powerful metaphors, help to build consensus and guide future work. In a second constituent phase, the detailed testing and resolution of conflicting requirements are worked out. Three outcomes of this phase are theoretically possible. If the interests behind the first primary concepts are strong, such as when using a skilful and influential architect or production engineer, these concepts prevail and other important requirements are modified or abandoned to fit in. In a second type of outcome, strong partial interests can deform the primary concepts to produce a bland compromise.

Examples of the third, successful type of outcome can often be found among old buildings, which through first-rate professional work and sufficient time for careful design, have managed to stay remarkably beautiful, durable and useful over a long period of time. For example, the Luma light bulb factory in Stockholm, designed by Arthur von Schmalensee and Eskil Sundahl in 1929–30, is a case in question. We interpret the success to be due to thorough functional analysis on one hand, which has given the building character and identity, and an endeavor for simplicity and elegance on the other hand. All important requirements have been met, while an extensive brief has passed through a process of consolidation. The form has been cultivated and clarified to a simple and distinct structure, which can be extended and used for other purposes also.

The repetitive, iterative character of the process must be emphasized. Each design passes through the conceptual, constituent and consolidatory phases several times. It is easy to neglect any of these three phases, each representing an important lesson to be learned. Architects often like to think that their primary concepts are new and unique instead of borrowed and assimilated from a vast repertoire of historical examples. In the second phase the involvement of a broad array of various interests and competencies is important. Technical experts, employees, community interests – must all be given a say. The complexity of this calls for a structured process, similar to the urban planning process, in which interaction takes place at different, well-chosen points in time, where the decision problems are sufficiently complex to stimulate creativity but not so entangled as to be unmanageable (Törnqvist, 1992).

This interaction should be seen not only as a negotiation process with well-known alternative outcomes, but as a learning process, where creative and new solutions are possible (Clipson & Kornbluh, 1993) Recently new insights have been gained concerning how this enabling and learning process of interaction could be reinforced. Shared practical and sensory experiences of the concrete design object is important in order to facilitate understanding through a common language. As Ehn (1988, 1992) and Granath (1991) have shown, even simple cardboard models of possible artefact designs are helpful to promote a common understanding.

The role of metaphors

Symbols express values, which make associations with history or with an industrial activity, for example, the adornment of the smoke chimney was seen as a sign of power. Symbols could be likened to words and simple phrases. To create richer language games a formal syntax and more complex metaphors are needed. A Greek temple or a Roman basilica are characterized not only by certain details but also by a syntax, which determines how to proportion and combine these details.

Metaphors are motifs and form-generating ideas capable of creating a clear Gestalt out of a complex aggregate, borrowed from nature or social situations – such as the factory as prison (Foucault, 1975), school or castle. The design of a complex building is often inspired by a combination of metaphors, for example when the Volvo Uddevalla plant brings reminiscences of both the former ship-building plant and an Italian manorial farm. Metaphors are more concrete and suggestive than verbal guidelines, but less precise than drawings. They fulfil the contradictory roles of embodying the radically new and allowing room for old continuities and incremental future adaptations, both of which are important conditions for change in large organizations.

Metaphors play an important part in all three phases of the design process. Primary concepts are often metaphors, facilitating interaction between various interests in the constituent phase. But in the third phase, a critical view of established metaphors is necessary and the generating of new ones should be encouraged. The extreme closedness and technical efficiency of the ‘beehive’ hexagon at Kalmar should have given rise to doubt concerning its openness and ability to accommodate future production changes. The mixture of ship-yard sheds and Italian farm buildings, while visually effective may not be a robust or appropriate combination of metaphors. Genuine conflicts between strong opposing interests can not be hidden for long behind harmonious and symmetrical exteriors but should be expressed appropriately. Metaphors more related to the local surroundings, to the genius loci at both Kalmar and Uddevalla, probably would have been better.

Today the visually distinctive Volvo buildings now stand as graphic signs of a dynamic but unfortunately short period of technological, organizational and architectural development.

Conclusion

Much like the General Motors Saturn plant, the Volvo factories at Kalmar and Uddevalla have made their more progressive tendencies less irksome to the parent organization. The godchild as satellite producer may never rival the parent in size or product share without running the risk of more corporate control and limiting initiative. Uddevalla and Kalmar, despite their pioneering examples and productive value have fallen out of favour of the traditional parent, and therefore have been banished. A distinctive architectural design probably helped to promote and establish the pioneer spirit that made the plants successful in the short run. The designers also made use of the possibilities to create an excellent physical work environment with small-scale, well organized work team areas, amply provided with daylight and social spaces. But a planning process with too little attention to a collaborative choice of suitable design metaphors led to weaknesses in more subtle and long-term qualities. Although Uddevalla in particular seems to have adaptive possibilities for other production, one is tempted to think that the conspicuous form and strong symbolism of both the Kalmar and Uddevalla buildings contributed to the ostracism they suffered.

References

- Berggren, C. (1993), *Mästar prestationer eller mardrömsfabriker? En utvärdering av Volvos småskaliga monteringsfabriker i Uddevalla och Kalmar*. (First class performances or nightmare factories? An evaluation of Volvo's small scale assembly plants at Uddevalla and Kalmar), Working paper, Sept 1993, Department of Work Science, Royal Institute of Technology, Stockholm.
- Chase R. B. and Garvin D. A. (1989), 'The Service Factory', in *Harvard Business Review*, July/August.
- Clipson, C. and Kornbluh, H. (1993), 'Designing and Learning: Toward a Redefinition of Participatory Workplace Design Process', in Törnqvist & Ullmark (ed.), *Appropriate Architecture, Workplace Design in Post-Industrial Society, Industrial Planning and Architecture*, Chalmers University of Technology, Gothenburg, and Industrial Planning, The Royal Institute of Technology, Stockholm.
- Clipson, C., Törnqvist, A. and Ullmark, P. (1993), 'New Paradigms for Production Environment – Examples from the Automobile Industry', in Törnqvist & Ullmark (ed.), *Appropriate Architecture, Workplace Design in Post-Industrial Society, Industrial Planning and Architecture*, Chalmers University of Technology, Gothenburg, and Industrial Planning, The Royal Institute of Technology, Stockholm.
- Ehn, P. (1988), *Work Oriented Design of Computer Artefacts*, Almqvist & Wiksell, Stockholm.
- (1992), 'Setting the Stage for Design as Action, Artefacts for Participatory Design in Theory and Practice', in Kazemian, R. (ed.), *Proceedings of the International Conference on Theories and Methods of Design, 13–15 May 1992, Gothenburg, Sweden*, Royal Institute of Technology, Stockholm, Chalmers University of Technology, Gothenburg.
- Foucault, M. (1975), *Discipline and Punish, The Birth of the Prison*, London.
- Frampton, K. (1976), 'The Volvo Case', *Lotus International*.
- Granath, J-Å. (1991), *Architecture, Technology and Human Factors, Design in a Socio-technical Context*, (Diss), Industrial Architecture and Planning, Chalmers University of Technology, Gothenburg.
- Hillier, W., and Hanson, J. (1984), *The Social Logic of Space*, Cambridge.
- Kazemian, R. (ed.), (1992), *Proceedings of the International Conference on Theories and Methods of Design, Göteborg, Sweden, 13–15 May, 1992*, The Royal Institute of Technology, Chalmers University of Technology.
- Lundeqvist, J. and Ullmark, P. (1993), 'Conceptual, Constituent and Consolidatory Phases – New Concepts for the Design of Industrial Buildings', in Törnqvist & Ullmark, (ed.), *Appropriate Architecture, Workplace Design in Post-Industrial Society, Industrial Planning and Architecture*, Chalmers University of Technology, Gothenburg, and Industrial Planning, The Royal Institute of Technology, Stockholm.
- Markus, T. A. (1993), Buildings and Social Relations, in Törnqvist & Ullmark, (ed.), *Appropriate Architecture, Workplace Design in Post-Industrial Society, Industrial Planning and Architecture*, Chalmers University of Technology,

- Gothenburg, and Industrial Planning, The Royal Institute of Technology, Stockholm.
- Peponis, J. (1985), 'The Spatial Culture of Factories', in *Human Relations*, Vol 36, No 4, 1985.
- Schön, D. (1983), *The Reflective Practitioner, How Professionals Think in Action*, Basic Books, New York.
- Steen, J. and Ullmark, P. (1992), 'Planning for Good Working Conditions', in Kazemian, R. (ed.), *Proceedings of the International Conference on Theories and Methods of Design, 13–15 May 1992, Gothenburg, Sweden*, Royal Institute of Technology, Stockholm, Chalmers University of Technology, Gothenburg.
- Törnqvist, A. (1989), 'Volvo in Kalmar, A First Step Forward', in Törnqvist & Ullmark, (ed.), (1989), *When People Matter, Nordic Industrial Architecture and Engineering Design*, Swedish Council for Building Research, D14:1989, Stockholm.
- (1989), 'Volvo in Uddevalla, Building the Whole Car', in Törnqvist & Ullmark, (ed.), *When People Matter, Nordic Industrial Architecture and Engineering Design*, Swedish Council for Building Research, D14:1989, Stockholm.
- (1992), 'The Influence of Legal Rules on Creative Interaction', in Kazemian, R. (ed), *Proceedings of the International Conference on Theories and Methods of Design, 13–15 May 1992, Gothenburg, Sweden*, Royal Institute of Technology, Stockholm, Chalmers University of Technology, Gothenburg.
- Törnqvist, A. and Ullmark, P. (ed.), (1989), *When People Matter, Nordic Industrial Architecture and Engineering Design*, Swedish Council for Building Research, D14:1989, Stockholm.
- (1993), *Appropriate Architecture, Workplace Design in Post-Industrial Society*, Chalmers University of Technology, Gothenburg, The Royal Institute of Technology, Stockholm.

Designed for learning: a tale of two auto plants

Paul S. Adler and Robert E. Cole

A consensus is emerging that the hallmark of tomorrow's most effective organizations will be their capacity to learn. To survive in the competitive turbulence that is engulfing a growing number of industries, firms will need to pinpoint innovative practices rapidly, to communicate them to their employees and suppliers, and to stimulate further innovation.

However, there are two very different views on the organizational design most effective to support learning, particularly in more labor-intensive production of relatively standardized products.¹ Proponents of the Japanese-inspired 'lean production model', such as the MIT researchers who contributed to *The Machine That Changed The World*, argue that organizational learning will be maximized in a system based on specialized work tasks supplemented by modest doses of job rotation and great discipline in the definition and implementation of detailed work procedures.² By contrast, European managers, union officials, and academics are engaged in a lively discussion on the possibility of a German-Scandinavian alternative.³ Proponents of this 'human-centered model' argue that organizational adaptability and learning is best served by greatly lengthened work cycles and a return to craft-like work forms that give teams substantial latitude in how they perform their tasks and authority over what have traditionally been higher-level management decisions.

Toyota is often credited with pioneering the key elements of the lean production model. In the United States, the best documented of Toyota's plants is the Toyota General Motors (GM) joint venture, the New United Motor Manufacturing, Inc. (NUMMI) plant in California. Volvo's Uddevalla plant exemplifies the human-centered alternative. It is one of Volvo's most innovative plants, radically extending the long cycle and team autonomy concepts that shaped the famous Kalmar plant.⁴

In November 1992, Volvo announced that it would close the Uddevalla and Kalmar plants, but these plant closings should not close the debate over

the significance of their innovations. The two plants are not being shut down due to poor performance. In fact, Kalmar operated at productivity and quality levels higher than those at Volvo's main Torslanda plant, and Uddevalla was already matching Torslanda in productivity. However, Volvo was operating at very low capacity utilization levels, and managers believed that shutting down the two smaller plants was an effective way to reduce total overhead. Although Volvo's innovations in work organization will continue in some of its truck and component plants, the closing of these two plants will end a remarkable twenty-five year period in which Volvo's efforts to humanize and democratize work inspired managers, union officials, and academics around the world. The concept of self-managing teams so popular in the United States today owes much to these two plants, as does the design of G.M.'s Saturn plant. Whether the advocates of work reorganization within Volvo will be able to refocus their efforts on reforming Volvo's other facilities remains to be seen. Whatever the case, there is much to be learned from the Kalmar and Uddevalla experience.

Between us, we have studied firsthand a number of Toyota's Japanese plants, the NUMMI facility, and several Volvo facilities, including Uddevalla. In this article, we assess the relative merits of NUMMI and Uddevalla as organizations designed to support learning. In brief, we argue that although elements of the Uddevalla approach do indeed promise a higher potential for *individual* learning, NUMMI is the more effective model for encouraging *organizational* learning. The NUMMI model thus assures a higher growth rate for productivity and manufacturing quality. Proponents of the Uddevalla model argue that the NUMMI model's purported technical strengths will be overshadowed by its lack of opportunities for personal development and that its regimentation will undercut worker motivation. We believe that this critique is misconceived and that the intense discipline created by NUMMI's job design creates not only world class performance but also a highly motivating work environment.

First, we describe some of the key aspects of the two plants' organizational designs. Then we compare their performance results and identify some technical factors that may contribute to these results. Finally, we closely examine the social factors and critique some popular misapprehensions about the sources of motivation and of organizational learning.

Comparing two organizational designs

NUMMI and Uddevalla are similar in several important respects. They are both truly committed to treating employees as their most important assets and to providing opportunities for employee growth. For both plants, governance is accomplished by a relatively strong partnership between union

and management. They are also similar in the relatively strong partnership between union and management. Finally, they are both organized around production teams.

But the similarities give way to important differences when we examine the internal organization more closely. The NUMMI and Uddevalla production teams are very different. At NUMMI, teams are composed of four or five workers under a team leader, and both team members and team leaders are hourly workers. Each team member performs a work cycle of about sixty seconds. In the final assembly department, the teams are linked in series, in the traditional 'Fordist' assembly line pattern. Toyota's just-in-time inventory system ensures that this interdependence is very taut. Teams take on responsibilities not normally the province of line workers in U.S. auto plants, in particular for quality assurance, preventive maintenance, and internal job rotation schedules. They also define work methods and standards, but must satisfy managers and engineers that these methods and standards are optimal and that they are implemented identically across workers and shifts. Although such worker involvement in defining methods violates Frederick Taylor's principles of 'scientific management', the resulting job designs are very Tayloristic in their narrow scope and gesture-by-gesture regimentation.

At Uddevalla, the break with Taylorism and Fordism was deliberate and radical. The plant's model evolved at a time when Volvo was experiencing a production capacity bottleneck in a protected market with no efficient Japanese competitors for its niche. In the mid-1980s, Volvo was selling everything it could make, and lack of productive capacity was the problem. The major constraint in breaking the capacity bottleneck was the tight Swedish labor market. The design of the Uddevalla plant was labor-market driven, not product-market driven. As one of the key managers involved in the plant design expressed it, 'The problem we had was how could we make the plant attractive for Swedish workers to want to work in it.'

In the newly designed plant, each of eight production teams took full responsibility for assembling the vehicle from the subsystems up – a work cycle of about two hours. The plant abolished the assembly line, as the eight teams worked in parallel. The teams were larger, ten people as opposed to four or five at NUMMI. Because the work cycle was so long, Uddevalla teams paid much less attention than NUMMI's teams to the detailed, gesture-by-gesture standardization and instead focused on the more aggregated balance of tasks within the whole assembly cycle. Not only did Uddevalla teams decide job rotation schedules, they also selected their own hires and decided on their own overtime schedules. At NUMMI, union representatives and managers jointly select team leaders based on objective tests, whereas at Uddevalla, teams selected their own leaders and often rotated the role.

Both organizations put great stock in worker training. NUMMI has invested considerable time and effort in training workers in the principles and techniques of its production system, but it offers no pay premium for the accumulation of new skills. At Uddevalla, team members' pay increased with the accumulation of proved expertise.

Comparing performance results

NUMMI took over the old GM plant in Fremont and hired about 85% of its workforce from the ranks of laid-off GM-Fremont workers. Pilot production began in December 1984, and by 1986, NUMMI was almost as productive as its sister Toyota plant in Takaoka and more productive than any other GM plant. Total hourly and salaried hours per vehicle averaged 20.8 at NUMMI in 1986, as opposed to 18.0 in Takaoka, 40.7 in the relatively comparable GM-Framingham plant, and 43.1 at the old GM-Fremont plant in 1978. Inventory levels averaged two days, which was significantly below U.S. auto industry averages, but still above the two hour level prevailing in Takaoka, primarily due to difficulties in running true just-in-time inventory with suppliers from Japan and the U.S. Midwest.⁵

More recent data indicate that this extraordinary performance was not merely a honeymoon phenomenon. According to a J.D. Power and Associates study of the number of problems per 100 vehicles experienced by customers within 90 days of purchase, NUMMI scored 116 in 1989, compared to an industry average of 148 for all cars sold in the United States. The number of problems went up in 1990 with the introduction of Geo Prizm and new domestic suppliers but then decreased to 93 in 1991 and to 83 in 1992 (when the industry average was 125 for all cars sold in the United States and the average for Asian nameplates was 105; for U.S. nameplates, 136; and for Europeans, 158).⁶

What of NUMMI's quality of worklife? Here, too, the indicators are very impressive:

- Absenteeism has held steady at about 3 percent.
- Participation in the suggestion program had increased to over 90 percent by 1991, and workers made over 10,000 suggestions that year, an average of about 5 suggestions per worker. The implementation rate for these suggestions was over 80 percent, which reflects as much or more on NUMMI's policy of encouraging involvement as on the quality of the suggestions themselves.
- Internal surveys of worker attitudes showed that the overall proportion of people describing themselves as satisfied or very satisfied with their job at NUMMI had increased from 76 percent in 1987 to 85 percent in 1989 and to 90 percent in 1991

How does this compare with the Uddevalla plant? Unfortunately, the data here are sketchy:

- According to a *New York Times* article, it took fifty hours to assemble a vehicle at Uddevalla as opposed to an average of twenty-two hours for Japanese plants in the United States.⁷ When we visited the plant in the summer of 1991, the plant manager claimed that these data were old and that the plant had already reached the productivity of the Torslanda plant, which this *Times* article estimated at forty hours per vehicle. Even adjusting for the larger size of the vehicles produced at Uddevalla, the productivity differential would be substantial. (Unfortunately, we have no comparable quality data on Uddevalla's output).
- Although absenteeism was half that of Volvo's main plant at Torslanda, it was still very high: sick leave absences averaged about 12 percent in 1990 and long-term disability about 10 percent for a total of about 22 percent – compared to 3 percent absenteeism at NUMMI. Uddevalla workers benefited from much more generous sick leave provisions, and it is possible that NUMMI's strictness on absenteeism does not allow workers sufficient flexibility to balance work- and non-worklife. It is nevertheless clear that Uddevalla's worklife did not provide sufficient intrinsic satisfaction to overcome the long-standing Swedish tradition of high absenteeism rates.
- Turnover was high during Uddevalla's startup because some workers without industrial work experience did not accommodate to the pressures of the very demanding work in auto assembly. However, turnover had settled at about 6 percent by 1991. This figure is comparable to NUMMI's, but turnover, like absenteeism, is influenced by many factors outside the plant's control.
- More telling, perhaps, was a 1992 survey of worker satisfaction across Volvo's plants, which revealed that Uddevalla scored in a similar range to the very traditional Torslanda plant. This was a big disappointment to management, which could only argue that it was the reflection of the workers' high expectations. This argument has some merit, but such a score also suggests that craft-style production may have been idealized by Uddevalla's designers and oversold as a cure to the ills of modern labor.

Perhaps we too have succumbed to this idealized view, because we think that Uddevalla, not NUMMI, would be the more desirable place to work. Uddevalla offered a much less regimented environment, more task variety, more autonomy, and a lot more team self-management. However, there is little doubt as to which production system is capable of delivering the greatest efficiency and quality: it is NUMMI.⁸ In fact, one Volvo executive we

interviewed stated flatly that Uddevalla would not have been built under today's circumstances, and it would be hard to find others at Volvo who would disagree. The context that produced Uddevalla has changed. The labor bottleneck has disappeared and efficient Japanese competitors are hurting Volvo in its export markets.

The question remains: Is the technical and economic superiority of the NUMMI system achieved at the expense of workers' well-being?

Interpreting the results: Some methodological difficulties

Critics of the lean production system argue that it does not provide a viable model for production organization. Two variants of the criticism have been articulated:

One line of criticism argues that, in the lean system, workers are forced to work under excessive stress.⁹ As a result, their motivation to ensure world-class quality and their participation in the *kaizen* (continuous improvement) process will eventually taper off, and the potential benefits of standardized, narrow jobs will be outweighed by the costs of worker disaffection. An alternative hypothesis assumes that workers will continue to participate in *kaizen* efforts frequently enough to ensure its productive superiority, but they do so out of fear of losing their jobs. Thus their bodies and minds are under excessive stress, and many workers will quit their jobs exhausted after a few years, leaving society to pay the costs of this premature depreciation of our human resources.

Some observers have presented *prima facie* evidence for one or other of these scenarios and jump to the conclusion that NUMMI's production system is just a new way of further intensifying work effort, a form of 'ultra Taylorism'.¹⁰ Kamata's description of his experience as a temporary worker in Toyota City in the early 1970s and Fucini's description of the Mazda Flat Rock plant, for example, are cited as evidence supporting this characterization.¹¹ Parker and Slaughter have compiled an impressive dossier on the stress experienced by workers in some 'team concept' plants.¹²

But it is not easy to draw strong conclusions from the anecdotal evidence available. Public debate and scholarly research both confront a number of big methodological challenges in sorting out the relative merits of the alternative systems. First, many conceptions of the stressful, ergonomically unsound Japanese factory are based on old descriptions and images. In a recent systematic comparison of the Japanese and American auto industries, Richard Wokutch concluded that in spite of several significant weaknesses, safety and health conditions and practices in *large* Japanese auto firms were superior in many important respects to those in comparable American firms.¹³

Second, not all Japanese plants and transplants are identical. We should not assume that a practice found at one can be extrapolated to all. We should not assume that 'good practices' at NUMMI are necessarily representative of all transplants or for that matter that they are even representative of all Toyota plants. A good case can be made that the Japanese have been forced to modify the harsher aspects of their production system to make them more compatible with the expectations of Western workers. In this article, we focus on the NUMMI version of the Japanese production model.

Third, problems observed at a plant at a given point in time may not be inherent in the underlying model. For example, Uddevalla experienced a high rate of turnover during its startup, but this was for reasons that are largely unrelated to the central debate. A fair assessment should assume that both approaches are capable of learning and evolution.

Fourth, it is important to avoid the frequent polemic device of shifting the point of comparison. From the workers' perspective, production systems at Japanese transplants like NUMMI are far from ideal, but the ideal is a rather remote comparison point, and we need to use realistic comparison points to make reasonable assessments.

Finally, if the debate is over the merits of alternative production system designs, we should filter out as much as possible other, unrelated aspects of management. Some Japanese transplants, for example, have been criticized for discriminatory employment practices and for the difficult relations between U.S. managers and Japanese shadow managers.¹⁴ These management problems are often real and serious, but an alternative explanation is that these problems are symptomatic of Japanese firms' inexperience in international operations.¹⁵ Some of these practices do indeed appear racist, but it is certainly racist to assume that they are inherent features of Japanese management.

Interpreting the results: Technical aspects

To what then is NUMMI's productive superiority due? In particular, should this superiority be attributed to excessive stress imposed on workers? Our research suggests that the primary factor is NUMMI's effort to constantly improve the details of the production process. Such constant improvement is the key to productivity and quality in a product as standardized as an automobile. This constant improvement effort creates a certain level of stress, but as the worker attitude surveys show, the level is not so high as to degenerate into strain and distress.

Workers at both NUMMI and Uddevalla were encouraged to seek out improvements. And to help them, both groups received feedback on their task performance over their respective work cycles. But Toyota's stand-

ardized work system makes this feedback far more effective in sustaining improvement. At NUMMI, the work cycle is about sixty seconds long, and the performance of that cycle is very standardized. Therefore, it is easy to identify problems, define improvement opportunities, and implement improved processes.

Uddevalla workers, too, had detailed information on their work cycle performance, but as this cycle was some two hours long, they had no way to track their task performance at a more detailed level. This problem was exacerbated by the craft model of work organization that encouraged Uddevalla workers to believe that they should have considerable latitude in how they performed each cycle.

Some proponents of the Uddevalla design principles argue that it offers a way around the line-balancing problems that limit the efficiency of traditional sequential assembly lines.¹⁶ But NUMMI effectively resolves those problems through a combination of modest doses of worker flexibility (far less extensive than Uddevalla's) and aggressive efforts to reduce set-up times. The standardization of detailed work methods facilitate efforts to reduce set-up times. Moreover, as the variety of models produced in a given plant increases, it becomes increasingly difficult for workers to recall the right procedure for each job, and shorter cycle times with well-defined methods help assure quality. As a result, NUMMI's assembly-line can handle a relatively broad range of product types with minimal disruption.

Could the semiautonomous work teams at Uddevalla have come to see shorter work cycles and formalized methods as a better way and adopted it autonomously? Although Uddevalla had a bonus system that encouraged work teams to improve performance continually, the teams had neither the focus on the kinds of microscopic *kaizen* opportunities that drive NUMMI performance (because of Uddevalla's long work cycle) nor the tools to capture these opportunities (because they lacked standardized work processes). To the contrary, in fall 1991, we were informed that there were no detailed documentation available to workers describing how to perform each work task and specifying how long it should take. One of the Uddevalla workers we interviewed argued, 'You don't really need all that detail because you can feel it when the task isn't going right, you can feel the sticking points yourself.' But workers at Uddevalla had no mechanism for identifying, testing, or diffusing the improvements that individual workers might make to eliminate these sticking points. The engineering staff from different work areas met to share new ideas. But without a well-documented, standardized process, it is hard to imagine how these people could have spotted improvement opportunities or shared them across the teams. You cannot sustain continual improvement in the production of products as standardized as automobiles without clear and detailed methods and standards.

Interpreting the results: Human aspects

The key points of contention in the debate over the human aspects of the competing models are work design and the broader plant governance process. Let us compare NUMMI and Uddevalla on these two key dimensions.

NUMMI's work organization follows what we have called the 'democratic Taylorism' model.¹⁷ As Frederick Taylor and modern industrial engineering practice recommend, jobs are specialized and work processes are standardized to the extent justified by the repetitiveness of the production task. But unlike traditional 'despotic Taylorism,' NUMMI's prescribed methods and standards are not designed to squeeze more work out of employees that management assumes are recalcitrant and irresponsible. Instead, these methods and standards are determined by work teams themselves: workers are taught how to time their own jobs with a stop watch, compare alternative procedures to determine the most efficient one, document the standard procedure to ensure that everyone can understand and implement it, and identify and propose improvements in that procedure. At any given time, the task of standardized work analysis might be delegated to a team leader or a team member, but everyone understands the analysis process and can participate in it.

At Uddevalla, work teams were left to their own devices. In the very early days of Uddevalla, managers gave workers the procedure documents from the Torslanda plant. But these procedures were not very well designed, as Torslanda is a traditional plant where workers play no role in defining procedures. As a result, the Uddevalla workers quickly discarded them, and along with them, the very idea of defining detailed methods and standards. In auto assembly operations, where competitiveness hinges so greatly on efficiency and manufacturing quality, this management philosophy sounds to us more like abandonment than empowerment.

There is one aspect of work design where we believe Uddevalla had the edge over NUMMI: Uddevalla's 'pay for knowledge' system provided substantial incentives for workers to build a deeper and broader knowledge. The United Auto Workers (UAW) contract at NUMMI does not allow such individualized pay systems. But here NUMMI is behind the practices of Japanese assembly plants, which have an elaborate system of skill grades as well as individual merit evaluations.¹⁸ These evaluations (*satei*) have been characterized by critics as an essentially manipulative tool of management control.¹⁹ Indeed, in the absence of a strong union, such manipulative use seems likely, and there is indeed evidence of such use in Japan. But if management wants workers to contribute innovative ideas – to act as knowledge workers – then reward systems will need to be redesigned to look more like those used for knowledge workers, such as the skill-and-merit systems typically used to reward engineers.²⁰ Clearly, if these systems are to be suc-

cessful, they will need to be implemented with the careful attention to equity that managers usually show in dealing with knowledge workers.

The second key dimension of comparison is at the plant governance level. Uddevalla had a democratic form of plant governance in which the union played a strong role in shaping the plant's design and operating policies.²¹ NUMMI, too, has relatively democratic plant governance. The union actively participates in a broad range of policy decisions that were previously closely guarded management prerogatives. Union and management representatives jointly investigate all problems; management has committed to advance consultation with the union on layoffs, schedule changes, and major investments; and management and the union jointly review any unusual or mitigating circumstances before employees are discharged or suspended. When workers objected to favoritism in the selection of team leaders, the union negotiated a selection process with an explicit set of criteria and a joint union-management selection committee.

Critics of NUMMI's system argue that the absence of firm, explicit contract language and the extent of informal, cooperative problem solving at NUMMI are symptomatic of a degeneration into 'company unionism.' We argue, to the contrary, that any democratization of plant governance inevitably must draw the union into greater partnership, and the Local leadership's effectiveness in representing worker interests in this new setting depends on management's commitment to cooperation as well as on the Local leaders' skills, the level of internal Local democracy, and the resources and guidance provided by the International. NUMMI's record in these areas is certainly not flawless, but nevertheless justifies strong optimism.²²

But the critics' concerns can then be restated: Can the NUMMI model, with the corresponding UAW influence and involvement, be sustained? And can it diffuse to other parts of U.S. industry? The critics can advance two arguments for their skepticism. First, the pattern of industrial relations we observe in Japanese industry might suggest that 'company unionism' is the more 'natural' counterpart to the Japanese-style production system. Second, the current industrial relations climate in the United States and the prevailing hostility to unions and to union-management cooperation put severe pressure on cooperation at NUMMI and create barriers to the diffusion of this cooperative model.

Our hopes for the future of the NUMMI model are based on the evidence suggesting that firms or regions that can sustain the more democratic variant of the lean model are well positioned to outcompete those that cannot. While the evidence for both sides of this debate is sketchy, we believe that it supports the argument that in the absence of strong, independent unions, the Japanese-style production system risks sliding into a despotic and less productive mode:

- The institutionalization of strong worker ‘voice’ seems to contribute significantly to NUMMI’s world-class performance.²³
- By contrast, in Toyota plants in Japan, worker voice is more muted and more often subordinated to corporate interests.²⁴ This situation contributes to the maintenance of difficult working conditions reflected in poor ergonomics, excessive overtime, and stressful pressures, especially in small subcontract firms. These difficult working conditions relative to other industries make it difficult to recruit new workers, thus undermining the viability of the Japanese variant of the Toyota production system.²⁵
- Strong worker voice is difficult to sustain in the absence of independent unions. In the United States, those nonunion plants that do afford workers a real voice often appear to do so as part of a union-avoidance strategy. Where these ‘progressive’ personnel policies are due instead to the genuine humanism of the plant manager, the resulting employee relations system is fragile since workers can easily conclude that their influence is only accepted at the discretion of management and within the limits circumscribed by management.

To summarize this section, then, if we ask whether NUMMI provides as much scope as Uddevalla for the development of workers’ human potential, our answer remains, unfortunately, no. But does it create an oppressive, alienating, stultifying work environment? The answer must be, emphatically, no.

If Uddevalla’s productivity and quality potential were close to NUMMI’s, then its human advantages would tip the scale in Uddevalla’s favor. A small gap in productivity and quality could be overcome easily by judicious public policy support. The available evidence suggests, however, that: (1) Uddevalla was not within striking difference of NUMMI’s productivity and quality, and (2) NUMMI’s quality of worklife, although not ideal, is in the ‘acceptable’ range as far as workers are concerned. We conclude that Uddevalla, if it had survived, would have had to evolve in dramatically new directions in order to qualify as a viable option.

Challenging some underlying assumptions

The goal of Uddevalla’s work organization was to create a ‘new profession of car-builder’ based on ‘a model drawn from the system of craftsmen and guilds, with apprentices, journeymen and masters’.²⁶ The assumption underlying this approach is that a work organization based on narrow tasks and detailed standards is intrinsically dehumanizing. We believe that the NUMMI case shows this assumption to be wrong. NUMMI’s approach to standardized work shows that Tayloristic efforts to define the technically optimal ‘one best way’ are not necessarily weapons used by management to

extract maximal effort from a recalcitrant workforce. In fact, there are three ways that the knowledge required to make improvements can be used: (1) by management, coercively forcing ever-higher levels of work intensity; (2) by workers, covertly using that knowledge to reduce their own work effort (back to the 'soldiering' observed by Taylor!); and (3) by the joint efforts of workers, managers, and engineers to fuel a continuous improvement of efficiency and quality without intensifying work beyond workers' capacities. We believe that the NUMMI case demonstrates that the third option is possible. Practices in Japanese plants and in other 'lean' transplants probably vary considerably in this respect, but NUMMI shows that continuous improvement does not have to be based on an escalating appropriation of workers' know-how.

The contrast between Uddevalla and NUMMI also leads us to challenge a second widely held assumption: that world-class performance can be based only on very high intrinsic work satisfaction. It would be wonderful if we lived in a world where every job could be an opportunity for Maslovian self-actualization. But when products are fairly standard and mass-produced, and when automation is still not cheap enough to eliminate labour-intensive methods of production, then efficiency requires narrowly specialized job assignments and formalized standard methods – a form of work organization that precludes the very high intrinsic work satisfaction that would, for example, stimulate workers to come in without pay on a day off to tackle a production problem. Is this equation merely the result of 'corporate greed' as some critics contend? We think not: any community that needs such standardized goods will object to paying the exorbitant costs associated with an inefficient and poor quality production organization.

As we have argued, the quality of worklife in such industries can be much improved by democratizing the work design process and business governance processes. Clearly these changes leave work in the category of 'instrumental necessity' rather than 'self-actualization opportunity.' NUMMI shows us, however, that even when work has a basically instrumental function for workers, it can be organized to sustain both a moderately high level of worker motivation and world-class performance.²⁷

A third assumption built into the Uddevalla approach and one that underlies much of Western industry is that an increase in individual learning automatically leads to an increase in organizational learning. This is a fundamental fallacy. The Japanese model does not take organizational learning as a given; managers consciously work to create policies and practices which facilitate it.²⁸

Uddevalla designed an extremely impressive range of personal learning opportunities for its employees. Workers spent the first sixteen months developing basic skills, then progressively learned all of the jobs on their

teams until they could build the entire car themselves. Then they went on to develop teacher competence, team spokesperson competence, and skills in other managerial and engineering areas. But this emphasis on individual learning had no counterpart in organizational learning. Team autonomy and decision decentralization were Uddevalla's central design objectives. As a consequence, little thought was given to how work groups might learn from one another to facilitate continuous improvement. Indeed, in an interview we conducted, the plant design project leader described how the planning team ignored the need for cross-group organizational learning: 'We didn't put much thought into how to learn from other groups. Our focus was on building jobs bigger – to lengthen and widen the job; that was what we were aiming for.'

In contrast, the Japanese production model explicitly focuses on strategies for organizational learning. Standardization of work methods is a precondition for achieving this end – you cannot identify the sources of problems in a process you have not standardized. Standardization captures best practice and facilitates the diffusion of improvement ideas throughout the organization – you cannot diffuse what you have not standardized. And standardization stimulates improvement – every worker is now something of an industrial engineer. At NUMMI, the skill development strategies for individual workers are managed as a component of this process, rather than as a way of maximizing personal opportunities. As a result, training focuses on developing *deeper* knowledge, not only of the relatively narrow jobs but also of the logic of the production system, statistical process control, and problem-solving processes. Understanding a *broader* range of jobs – the focus of Uddevalla's skill development approach – is recognized as an important stimulus to *kaizen* efforts, but this broadening of skills builds on, rather than replaces, the standardized work process and the deepening of skills. Our study of NUMMI suggests that management may not be sufficiently attentive to the importance of planned skill broadening, but the sister Japanese plants systematically rotate workers through related departments over a period of years.

Conclusion

We have argued that NUMMI's combination of technical-economic and quality-of-worklife strengths makes its production system the most appropriate type for relatively repetitive, labor-intensive activities like auto assembly. It is worth asking whether this system will be undermined by the progressive automation of these activities, by changing worker expectations, and by the shift toward volatile markets, lower volumes, and greater product variety. Was Uddevalla simply ahead of its time?

At first sight, the recent innovations at Nissan's new Kyushu plant seem to support such speculation. In response to labor market conditions – a tight Japanese labor market, the difficulty of attracting workers to auto assembly, and the long-term projections of labor shortages – Nissan has eliminated the conveyor belt, has installed significantly more automation, and is using many of the ergonomic job designs that characterized Uddevalla.²⁹ Indeed, Japanese auto executives were among the most frequent visitors to Uddevalla.

But these new plant designs do not suggest that the Japanese are switching to an Uddevalla model. First, ergonomic work task designs are a distinguishing feature not of the Swedish model but of enlightened management faced with tight labor markets. Second, the work cycle has remained short and very standardized. Third, with lower volumes and greater product variety, the natural learning curve effect is even less reliable, and these plants will therefore pursue even more aggressive standardized work efforts to ensure efficiency and quality.

The more appropriate lesson to draw is that both the lean production system and the Uddevalla alternative have extensive room to evolve and develop. If Uddevalla had survived, it would have had to evolve in dramatically new ways to be competitive in productivity and quality. Whether it would have done so quickly enough and whether it would have retained its distinctive worker-oriented features is unclear.

In the case of the lean production system, we expect that it will evolve to be more employee-oriented. In Japanese plants, managers will need to adjust to the long-term prospects of labor shortage and to changes in workers' expectations as Japanese seek to enjoy more of the rewards of their extraordinary hard work. In Japanese production system plants outside Japan, the speed of this shift toward more employee orientation will depend on local factors. But the combination of standardized work and more democratic management has proven potent at NUMMI in its ability to sustain both continuous improvement and worker morale. It might well represent the model for the next generation of labor-intensive, mass-production activities.

Our thanks to J.D. Power and Associates for permission to reproduce copyrighted data. Their unauthorized reproduction is prohibited.

Reprinted from *Sloan Management Review*, spring 1993, pp 85–94, by permission of publisher. Copyright 1993 by the Sloan Management Review Ass. All rights reserved.

Postscript: Uddevalla and the Japanese one more time

Christian Berggren begins his defense of Uddevalla¹ and critique of the Japanese approach by dismissing productivity comparisons with some methodological disclaimers showing the difficulty of comparing different plants. To be sure, productivity comparisons are always difficult; we will return to the methodological issues below. It is clear, however, that the productivity advantage of the Japanese over European and American car producers in the late 1980s and early 1990s was of such a magnitude, as to allow them to take market share almost at will, were it not for protectionist barriers or self-imposed restraints to avoid protectionist barriers. This market test is decisive.

There is, however, something more to be said regarding the available research data. First, notwithstanding his methodological hesitations, Berggren does himself offer some data in an effort to refute the claim by James Womack that: 'Uddevalla is not in the ballpark'.² Unfortunately, these data do little to reassure us that Uddevalla was even close to the productivity or quality standards set by Japanese producers. Berggren tells us that in September of 1992, Uddevalla was taking 36 hours to assemble a car and that its mid-1993 target of 25 hours seemed within reach. These results can be compared meaningfully, if only approximately, against the performance of other producers. Berggren protests that the IMVP data only covers a subset of assembly activities, but with the generous assistance of John Paul MacDuffie, we have been able to make the appropriate adjustments to both the IMVP averages and Berggren's Uddevalla data.

The IMVP data needs to be adjusted to exclude salaried personnel, which were not included by Berggren, and welding and paint operations, which were not performed at Uddevalla. In the absence of further detailed information, we have adjusted the IMVP data by allocating indirect labor hours to final assembly in proportion to the share of final assembly in the overall plant operations. The net result is that the IMVP averages must be reduced by a factor of 54 percent figure.³

The Uddevalla data must in turn be adjusted for the presence of exhaust and door subassembly operations (which were excluded from the IMVP data), for the Volvo 940's relatively large size, and for its high option content. These adjustments were based on our estimates of Volvo production and on the worldwide IMVP sample averages. Together they reduce Uddevalla's hours per car by 3.6. Following the IMVP methodology, we have further adjusted the Uddevalla data for total absenteeism, reducing their estimated hours per vehicle by a further 20 percent.⁴ The net result is that the adjusted Uddevalla hours per vehicle in September of 1992 was 25.9, and the target for 1993 was 17.1. These can be compared against a Japanese luxury producer's average of 16.9 hours deflated by 0.54, or 9.1 hours, and against

the correspondingly deflated European luxury segment's average of 30.8 hours and the European volume producer's average of 19.2.⁵ One should note that the IMVP data are for 1989, and the performance of the Japanese and European competitors has certainly improved since then. While the comparison with the Japanese luxury segment may be a little unfair, since in 1989 it did not include cars as sophisticated as the Volvo 940, comparison with the European luxury segment is probably overly generous. The European luxury segment, after all, included Daimler-Benz and Jaguar, while Uddevalla's product, in terms of product complexity, brought it closer to the volume rather than the luxury segment.

A similar distributing gap appears in the quality results. Berggren reports that the J.D. Power rating for Uddevalla's products was 124 problems per 100 vehicles in 1992. This can be compared to a score of 46 for the Lexus LS400 (the top-ranked car), and 82 for the NUMMI Corolla (along with the Toyota Corolla, the top ranked small car). In summary, we do not see a basis for believing that when Uddevalla was shut down, it was close to approaching the Japanese standard. (The Lexus LS400 further improved its score in 1994 to just 32 problems per 100 cars.)

Much of Berggren's argument hinges on the dramatic improvements in productivity and quality that were achieved at Uddevalla since its opening and especially in the year preceding its closure. Our own evaluation supports this conclusion. The issue, however, is whether this impressive improvement was a temporary development or a prelude to sustained high rates of growth in productivity and quality, based on rapid organizational learning. Berggren assumes the latter; although we are not so sure. Any new plant, even under traditional management, undergoes rapid organizational learning and productivity improvement in its initial stages, as workers and managers learn their jobs and routines and learn to work with one another. Uddevalla represented a new way of building cars and was surrounded by publicity. These circumstances were certain to have further accelerated these learning processes. Moreover, prior to the closure decision, plant personnel knew that they had only a short time to prove themselves. Thus, an enormous amount of 'crisis learning' took place as managers and workers alike, sought to identify and remove bottlenecks to productivity improvement. In talking with a number of these people, we were impressed with their determination and commitment to make Uddevalla work.

Strong initial start-up and crisis learning, however, do not insure that the organizational learning necessary for sustained productivity and quality improvement in day-to-day normal operations is in place. In a crisis, people break normal routines to learn and diffuse best practices. But in most organizations on a day-to-day basis, it is the normal work routine which structures and modulates the learning process. We can not assume

that Uddevalla could have sustained its rate of organizational learning and associated productivity and quality improvements in a mature operation. Indeed, it is just as plausible to argue that they would regress, since people typically return to their 'normal' routines when crises subside. Many of the learning activities in the design and start-up phase of Uddevalla were organized as independent projects staffed by personnel and external consultants engaged on a temporary basis. As Ellegård and associates acknowledge, hard-won knowledge can easily be subsequently lost to the organization in this situation.⁶ Therefore, we need to examine whether the mechanisms had been put in place to insure continued high rates of growth in productivity and quality.

Our doubts in this regard are based primarily on two issues that we believe were not sufficiently addressed by Christian Berggren. First, we continue to believe that standardized work is a precondition for sustained efficiency and quality improvement. One can not systematically improve, what one has not standardized and measured. Standardization is about disseminating best practices across units and levels. The Japanese contribution has been to think about standardization in this novel fashion and to decentralize the process of standardization and make it the workers' responsibility.

In Swedish and in American industry, the term and indeed the very idea of standardization are stigmatized, as a result of the way it was used under traditional Taylorism. For example, if one looks at the treatment of standardization by a set of scholars closely involved in the Uddevalla development, one sees it presented in a most negative light.⁷ Berggren addresses our concerns about the absence of standardized work by claiming that new procedures documents had been completed and that their introduction in the assembly teams started in late 1991. This would seem to be a salutary change, but it prompts a number of questions. What were the worker's role in developing these documents and how would the workers be involved in implementing, maintaining, and improving these standards? What practices were put in place to identify and diffuse the most effective practices across the most relevant units? Unfortunately, Berggren is silent on such critical points, but they are at the heart of successful continuous improvement.

This leads us to another related concern. A major theme throughout the postwar history of the Swedish work reorganization movement has been a stress on the importance of autonomous work teams.⁸ In the case of the automotive industry, this interest grows in large part from the desire to turn short cycle work into long cycle work, as a remedy for the alienating effects of traditional auto assembly work. These driving forces in turn have naturally led researchers and those managers influenced by them to focus on individual and small group learning rather than organizational-wide learning.

These themes appear prominently in the work of a group of scholars

closely associated with the Uddevalla experiment. Their focus is on ‘natural group work’ which they see associated with long-cycle times.⁹ They stress the ‘holistic learning principle’ (helhetsinriktad lärandeprincip) but upon closer examination, the focus is clearly on learning within one’s particular natural group and insuring that this group has a broad view of the production process. Their strategy for Uddevalla was first to create long-cycle parallel final assembly and to develop the rest of the production system (e.g., component procurement, subassemblies of kitted systems, and storage facilities), to support this approach.

While occasional references are made to learning across groups and levels, this is not the primary focus. Rather, the emphasis is on the learning that goes on within autonomous work groups (autonom arbetsgrupp), as a solution to long-standing problems of worker motivation.

There is an emerging consensus, however, that many of the most fundamental roadblocks to improved productivity and quality are problems that require the cooperation of different groups within the production system. The conception of the autonomous work group, with its focus on the technical and administrative freedom of the group, does not adequately support the kind of organizational learning we believe to be essential for sustained productivity and quality improvement.¹⁰ As Berggren correctly notes, manufacturability is a key issue impacting final assembly time; yet manufacturability is achieved not just by engineers doing a better job but by intense structured iterative feedback between the different functional units in the organization. In looking at Berggren’s original treatment of Uddevalla, however, we see no indication that he, or those at Uddevalla, recognize that this is an important concern to be addressed. Instead, we see the usual focus on developing a long-cycle parallel production system with its implicit emphasis on expanding individual and small group learning.¹¹

As Berggren and Sandberg note, the interesting question is whether these problems we have identified are intrinsic to the Uddevalla approach or were external elements that were rapidly being jettisoned as Uddevalla came to grips with real world pressures. Would Uddevalla managers and workers have come to accept the need to adopt standardized work as a basis for improvement activities? Would they have come to downplay the role of autonomous work groups so that fuller and broader cooperative and learning could take place? And could these accommodations have been made without drastically revising the basic concepts of a parallel production flow that underlay the whole experiment? We do not know the answers to these questions though we have some strong doubts. Despite his claims to the contrary, we do not believe Christian Berggren knows that answers to these questions either. What we do know, and what we can all agree upon, is that it was a tragedy that the plant was closed and these questions will remain unanswered.

Notes to Designed for learning

1. By contrast, there is now a rather strong consensus on the organizational designs required to support learning in more automated settings and where product designs or services change very frequently. On automated settings, see: P.S. Adler, ed., *Technology and the Future of Work*, New York: Oxford University Press, 1992. On settings where designs or services frequently change, see: S. Davis and W. Davidson, *2020 Vision*, New York: Simon & Schuster, 1991.
2. J.P. Womack, D.T. Jones, and D. Roos, *The Machine That Changed the World*, New York: Rawson, 1990.
3. See F. Naschold, *Evaluation Report Commissioned by the Board of the LOM Programme*, Berlin: Science Center, 1992, pp. 2–3; and C. Berggren, *Alternatives to Lean Production*, Ithaca, New York: ILR Press, 1992.
4. See R.R. Rehder, 'Building Cars As If People Mattered', *Columbia Journal of World Business*, Summer 1992, pp. 57–70; and C. Berggren 1992.
5. J. Krafcik, 'Learning from NUMMI', Cambridge, Massachusetts: MIT Sloan School of Management, International Motor Vehicle Program, Working Paper, 1986.
6. *Power Report*, June 1992. Revised data for earlier years provided by J.D. Power and Associates.
7. 'Edgar Fray on Volvo's Brave New Humanistic World', *New York Times*, 7 July 1991, p. F5.
8. One caveat to this conclusion should be mentioned: the productivity and quality performance data are strongly influenced by the manufacturability of the respective vehicle designs. Toyota products' manufacturability has been ranked the best in the industry, whereas Volvo has been ranked fifteenth. See: J. Krafcik, 'The Effect of Design Manufacturability on Productivity and Quality: An Update of the IMVP Assembly Plant Study', Cambridge, Massachusetts: MIT Sloan School of Management, International Motor Vehicle Program, Working Paper, 1990.
9. See M. Parker and J. Slaughter, *Choosing Sides: Unions and the Team Concept*, Boston, Massachusetts: South End Press, 1988.
10. K. Dohse, U. Jurgens, and T. Malsch, 'From Fordism to Toytism? The Social Organization of the Labor Process in the Japanese Automobile Industry', *Politics and Society* 14 1985:115–146.
11. S. Kamata, *Japan in the Passing Lane*, New York: Random House, 1993; and J. Fucini and S. Fucini, *Working for the Japanese*, New York: Free Press, 1990.
12. Parker and Slaughter, 1988.
13. R. Wokutch, *Worker Protection, Japanese Style: Occupational Safety and Health in the Auto Industry*, Ithaca, New York: ILR Press, 1992, p. 225.

14. See, for example, Fucini and Fucini (1990); and R. Cole, 'Nihon kigyo yo, kokujin koyo no judaisei o shire' (Be aware of the importance of black employment in Japanese firms), *Chou Koron*, 10 October 1989.
15. R. Cole, 'Racial Factors in Site Location and Employment Patterns of Japanese Auto Firms in America', *California Management Review*, Fall 1988, pp. 9–22.
16. K. Ellegard, T. Engstrom and L. Nilsson, *Reforming Industrial Work: Principles and Reality*, Stockholm: Swedish Work Environment Fund, 1991.
17. P.S: Adler, 'The Learning Bureacracy: New United Motors Manufacturing Inc.', in *Research in Organizational Behavior*, eds. B.M. Staw and L.L. Cummings, Greenwich, Connecticut: JAI Press, 1992.
18. K. Koike, 'Learning and Incentive Systems in Japanese Industry', Paper presented to the conference 'Japan in a Global Economy: A European Perspective', held at Stockholm School of Economics, 5–6 September 1991.
19. K. Endo, 'Satei (Personal Assessment) and Inter-Worker Competition in Japanese Firms', *Industrial Relations*, in press.
20. Koike (1991).
21. C. Brown and M. Reich, 'When Does Cooperation Work? A Look at NUMMI and GM-Van Nuys', *California Management Review*, Summer 1989, pp. 26–37.
22. Adler (1992).
23. R.B. Freeman and J.L. Medoff, *What Do Unions Do?*, New York: Basic Books, 1984.
24. R. Cole, *Work Mobility and Participation*, Berkeley: University of California Press, 1979.
25. 'More Japanese Workers Demanding Shorter Hours and Less Hectic Work', *New York Times*, 3 March 1992, p. A6.
26. Ellegard et al. (1991), p. 25.
27. See P.S. Adler, 'Time-and-Motion Regained', *Harvard Business Review*, January–February 1993, pp. 97–108.
28. R. Cole, 'Different Quality Paradigms and Their Implications for Organizational Learning', Paper presented to the conference 'Japan in a Global Economy: A European Perspective', held at Stockholm School of Economics, 5–6 September 1991.
29. 'Factory Fantasia', *Automotive News*, 13 July 1992, pp. 3, 31; and 'Japan Lures Auto Workers with 'Dream' Factories', *New York Times*, 20 July 1992, pp. A1, D2.

Notes to Postscript

1. See Part II, page 100.
2. *New York Times*, 'Edges Fray on Volvo's Brave New Humanistic World,' July 2, 1991.
3. This is an average for the total worldwide luxury and volume producer samples. Regions differ by only plus or minus 3 percent.
4. This absenteeism adjustment is made by IMVP so that comparisons reflect the number of people actually involved in building cars on an average day, not the total number of people on the payroll. This makes allowance for factors beyond the control of plant management that might explain absenteeism, such as national social welfare policies regarding health-related absences. This adjustment may be overly generous to Uddevalla, since one of the goals of its holistic work design was to make work so attractive and interesting that absences would be greatly reduced.
5. See J. Womack et. al., *The Machine That Changed the World*. New York: Harper, 1990:89, Figure 4.3 for the IMVP averages for volume producers and page 89, Figure 4.5 for the luxury car segment data.
6. K. Ellegård et. al., 'The Development of Unique Production and Work Structuring Principles Through a Creative Search and Learning Process: The Volvo Uddevalla Final Assembly Plant', Brussels: EUROTECNET Technical Assistance Office, The Commission of the European Communities, Task Force Human Resources, Education Training and Youth, 1992:14.
7. K. Ellegård et. al., *Reflektiv Produktion*, Gothenburg: AB Volvo, Media, 1992:76.
8. R. Cole, *Strategies for Learning*, Berkeley: University of California Press, 1989.
9. K. Ellegård et. al., *Reflektiv Produktion*, Gothenburg: AB Volvo, Media, 1992: 82.
10. K. Ellågard et. al., *Reflektiv Produktion*, Gothenburg: AB Volvo, Media, 1992: 138.
11. C. Berggren, *Alternatives to Lean Production*, Ithaca: ILR Press, 1992: 146-166.

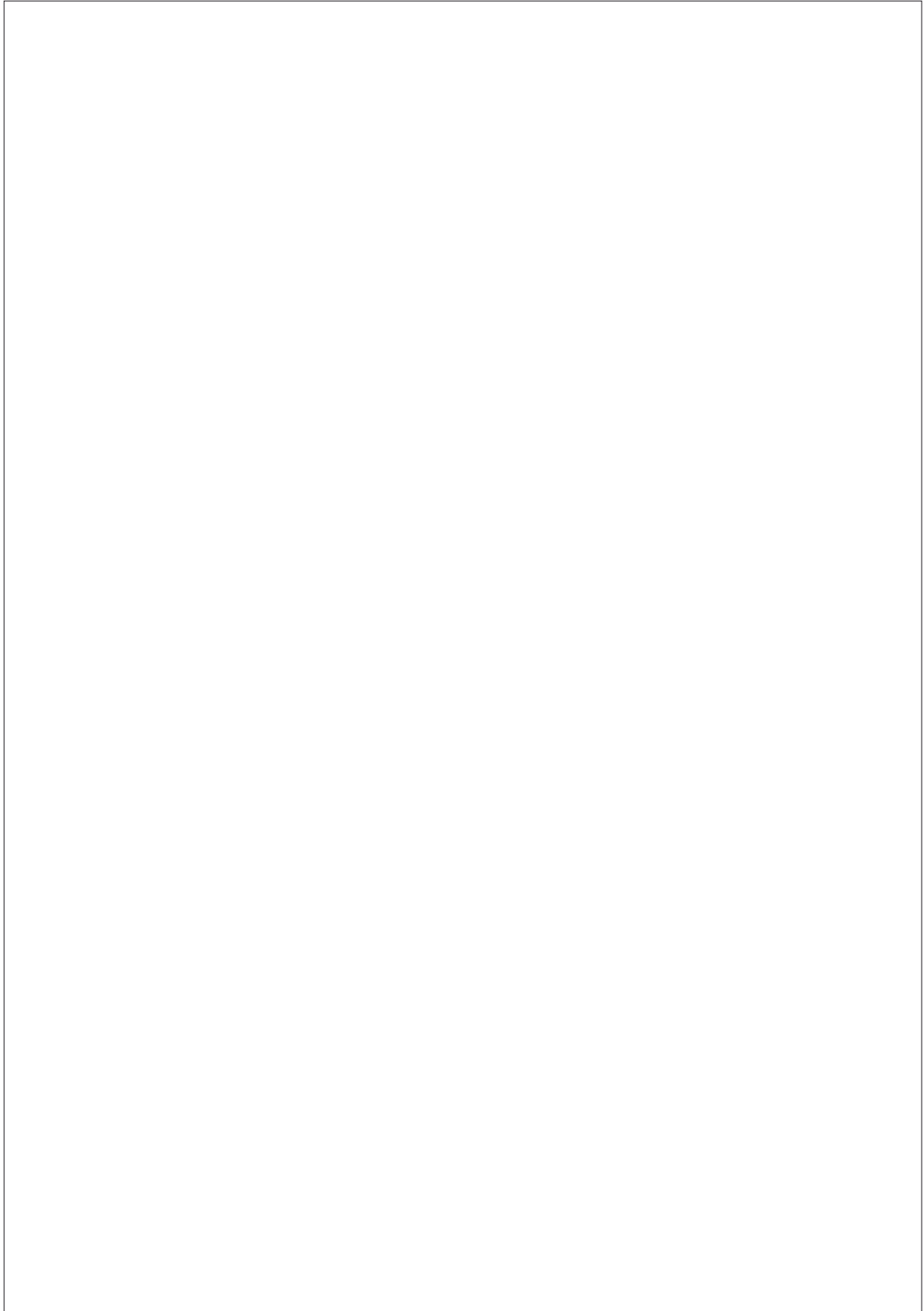

Limits to innovation in work organization?

An international comparison:
Volvo Uddevalla and GM Saturn

Bob Hancké and Saul Rubinstein

In May 1993, in a small former shipyard town on the west coast of Sweden, Volvo closed its Uddevalla plant. The plant had become famous in its four years of existence because it radically abandoned the assembly line. Cars were made by highly skilled workers who, in autonomous teams of 8 to 10, built an entire car. One month later on the other side of the Atlantic, in Spring Hill, a small town in the state of Tennessee, the Saturn Corporation added its third crew in order to utilize its full production capacity. Saturn is GM's newest attempt to regain lost share in the small car market: in this attempt, the local parties are trying to reinvent management.

There are many differences between the two companies beside the stories of apparent failure and success that open the article. The national systems of industrial relations they are embedded in, the motives and antecedents to each, day-to-day operations and work organization, the market segment they produce for, and finally their size and respective places in their parent organization are very different.

Yet the differences between Saturn and Uddevalla obscure an important set of issues for both organizations that have to do with the relationship between each and its parent corporate and union environment. (For reasons of style, we will, despite Uddevalla's demise, use the present tense for both throughout this paper.) First of all, they are relatively small operations in large corporations. Uddevalla is a final assembly plant in Sweden's most important industrial enterprise, Volvo, while Saturn is a wholly owned corporation of General Motors. Second, both Uddevalla and Saturn are operating laboratories in the search for innovative alternatives to the traditional organization of production. And third, unions were, in both cases, critical to the conceptual, planning and design phases, and as a result, the experience of both organizations sheds new light on the issues of labor's role in management.

Not the differences, but the similarity is at the basis of the comparison in this paper. Our basic point is that the degree of congruence between, on the one hand, the organizations and their vision of workers and management and, on the other, the wider corporate and union environment and structure, is a crucial variable in the assessment of the innovative organization's future (or, as in the case of Uddevalla, of its past): both the plant in Uddevalla and Saturn make a lot of sense economically, yet that alone does not guarantee their success within the overall organizational context in which they are embedded. This paper is a search for the other factors: how far can technological and organizational innovations go in such insular settings, and what role do institutions, in particular the wider corporate and industrial relations structure, play in these processes of innovation?

In this paper, we will use a synthesized version of the developments in Uddevalla, where the entire race has been run, as a way of suggesting questions about other innovative efforts in organizing production and work relations, specifically those at Saturn. The paper consists of three parts. The first part will lay out the terms of the debate on firm governance in manufacturing. In the second section, we will give a reinterpretation of the Uddevalla experience, followed by a discussion of the innovations at Saturn. The third and final section concludes by presenting a set of questions which we think follow from the analysis in this paper.

1. The social organization of car manufacturing

Ever since Henry Ford coupled the assembly line with exclusive management control on the shopfloor, and thereby increased productivity (and thus wages), car factories all over the world have moved to adopt both these technical and social systems. 'Fordism' also gave us a particular mode of work organization and firm governance that divided car-building (and in its path many other industries as well) into two distinct sets of activities, separated by an impenetrable wall. Managers, according to that model, conceived of investment, products, process and tasks, while workers executed tasks and, at most, bargained over wage levels through their unions. (Dankbaar 1992; Jürgens et al. 1989; Katz 1985).

Especially after World War II, therefore, firm governance in mass car production has followed a relatively simple, straightforward and universal path in Europe, the US and to a lesser extent Japan: management, 'the verb', was also really a task for management, 'the people', not because of technology or some inherent natural division of labor, but as a result of the way the knowledge to produce a car was divided between workers and managers. Management, on the shop-floor embodied in the person of the industrial engineer, designed the tasks to balance the line – that is, they di-

vided assembly up in small tasks in such a way that neither line nor workers would stand idle when the conveyor belt made its way through the factory and supervisors directed the workforce in order to efficiently coordinate those disparate tasks. Workers followed those orders, and that was where their responsibility stopped. World-wide, this was the predominant social organization of car manufacturing.

It was not until Japanese cars appeared on Western markets, first in the low-end segment and recently also in the luxury car segment, that the idea of alternatives to the Fordist division of authority was taken seriously for the first time. Whatever the particular form the argument took, they all built on different notions of the relationship between workers and managers (and of their responsibilities) than had prevailed in postwar mass-production. Instead of dividing the construction of a car into two different worlds – one of strategy, centered around conception and symbolized by control over investment – and the other of execution – with assembly tasks and wage-bargaining at its core – the Japanese tried to fuse the two by systematically integrating workers in production and design decisions. And instead of accentuating the social distance between workers and managers, the Japanese did just the opposite (Womack et al. 1990). Growing international competition has thrown into question the nature of authority structures under mass production regimes. Workers – and in many cases unions as well – have suddenly come to be perceived as strategic assets in global competition, and those countries where they have been – as in German and Japanese industry – are suddenly regarded as models, if not to emulate, then at least to borrow from freely (Dertouzos et al. 1989; Turner 1991; Streeck 1992).

Yet for the most part, the empowerment of workers has, even in this new system – definite limits and, despite the tighter integration of workers' knowledge into each step of the design and production process, management still manages without too much interference from workers or unions. In fact, judging from most accounts of industrial reorganization, these authority structures remain intact, with the traditional lines of demarcation in the workplace easily accommodating changes in workplace organization such as teams or quality programs that push part of the responsibility down to the shopfloor. Workers' participation has, in this new world, become an instrumental goal, and therefore limited to what is economically efficient.

We take issue with precisely this argument. Our primary aim in this contribution is to point out that serious alternatives to that traditional division of authority exist. Uddevalla and Saturn provide such alternatives far beyond what is limited by a purely economic rationale, since they deal with power-sharing in decision-making and are part of a broader social agenda. Furthermore, the two cases we discuss here point out that such alternatives to the conventional social organization of car manufacturing exist under both

line and stationary manual assembly, and that it is viable for both relatively inexpensive, standardized smaller and up-scale customized larger cars. We depart from the dominant views, however, in our point that the existence and survival of such alternative efficient modes of organization cannot be accounted for solely in economic terms; in order to understand their evolution, politics has to be taken into account explicitly (Kochan et al. 1986; Sabel 1982; Piore & Sabel 1984).

Both organizations embody – or at least have the potential to embody – a sharp break with the logic of management prerogatives and union domains that has dominated all Western political economies for most of this century, but especially since World War II. In Uddevalla, that break is a logical consequence of a production system that turns the conventional logic of assembly-lines on its head by reintegrating small tasks in long cycles. In Saturn, it is a result of the involvement of the union in both organizational governance and the day-to-day management of operations. The salience of the comparative treatment in this paper resides exactly in the way both organizations differ from their corporate and union environments. We will discuss that point in the next section and then move on to a detailed analysis of the two cases.

2. Breaking with tradition: Saturn and Uddevalla

The path-breaking approach to industrial relations makes both organizations exceptions in their own corporations. Saturn breaks with many accepted practices in manufacturing management inside GM. Volvo Uddevalla took the Swedish micro-model of production by autonomous teams to its logical conclusion. But whereas Saturn marks a clear break from traditional industrial relations practices in the US, and is exceptional because of that, the plant in Uddevalla is much less of a radical departure from those institutionalized facets of firm governance in Sweden and North-Western Europe more generally, in part because of the already extensive co-determination rights the unions have had in Volvo for many years. The relevance of the Swedish plant for this debate on firm governance is that it has taken us as far as we have ever been on the road toward work without supervision, where task conception and execution are again linked (many of the other chapters in this book cover this point in much more detail).

In Uddevalla, management as it has become known under the old Fordist structures, has all but disappeared. Self-managed teams deal with all or most of the former plant management functions: pacing, coordination, sequencing, parts supply, quality control, etc. Management head count is – hardly a surprise – very low: 16 managers for a workforce of roughly 900. Direct supervision is even lower: one shop manager supervises more than 100 work-

ers. Saturn is, as we will detail in the next section, the only car plant/firm that comes even close to this with a indirect/direct workers ratio of 1:50. Most plants operate at considerably tighter supervision levels of around 1:20. This compares very favorably with other car plants. Most GM operations, for example, have, on average, a supervisor-to-production-employee-ratio of 1:25;¹ NUMMI (the GM-Toyota joint venture) operates at 1:18² and the Japanese US transplants operate at approximately 1:20.

Worker autonomy is also very high in Uddevalla, job content is rich and the structure of the assembly task itself invites workers to permanently challenge and rethink what they are doing and come up with better ways, suited to their individual needs. Coordination of assembly too has, to a large extent, been decentralized to the teams. Management, in short, primarily brings expertise to the process, and given the workers' knowledge of their tasks, even that is highly dependent upon (and probably non-existent without) tight collaboration between workers and engineers.

Saturn challenges the conventional management logic too, but from an entirely different angle than Uddevalla. Whereas in Uddevalla the nature of the production technology is such as to throw into question the need for separate management functions, in Saturn the challenge is rooted in an attempt to reorganize and redistribute authority on the shopfloor. While the details will follow later, a preview will make this point clear in its general form. Throughout the Saturn Corporation, all elements of firm decision-making involve a consensus process between workers, represented by their local union, and management. This includes among others strategic business planning around product, process and quality, scheduling, suppliers, retailing – in short all functions that have traditionally been considered the exclusive domain of management. Further, the union has also taken on responsibility for co-managing operations by filling half of the line middle management positions with their own members. In Saturn, the labor union is defending workers' interests while jointly governing and co-managing the business.

In the following sections, we will detail these points for both Uddevalla and Saturn. We will direct our attention to the role of the labor unions, because (a) while we care deeply about the positive contributions democratic labor institutions can make in our industrial organizations, we are concerned about the current state of organized labor in most Western political economies, and (b) because we believe that the unions hold the key to understanding the innovations in both unconventional organizations. We will conclude the two discussions, of Uddevalla first and then of Saturn, with a short section that reiterates the basic elements of the cases in terms of our central idea about the 'politics of congruence'.

2.1 Volvo Uddevalla: Beauty is its own reward

The plant in Uddevalla is special because it is a ‘Copernican revolution in car assembly’ (Berggren 1990). Rather than having many workers who, in task cycles of one to two minutes, assemble a minute part of a car, the Volvo 940 that is produced in Uddevalla, is built one at a time by a small team of highly trained craftsmen, who have a knowledge of parts and their operation roughly comparable to a skilled car mechanic. Since the cars are built one at a time in small docks where they do not move during assembly, ultimate customization (and hence a price premium) is easily obtained.

Important to know is that the plant was a highly viable economic operation: productivity was very good and on a steep learning curve, capital costs, as expressed in basic investments and tool changes, were very low, quality and customization (and therefore the price of the Uddevalla cars) was very high, and the ‘social record’ of the plant, as expressed in, for instance, strains, stress and illnesses, was among the best in the world.³ Moreover, every car made in Uddevalla was a sold car. By the time the closure was announced, the plant built predominantly cars on order from the dealerships they had set up contacts with.

Despite the generally positive record, the plant closed in May 1993. What happened? Part of the explanation, we will argue, is indeed what others in this volume suggest: Volvo’s tremendous cash-flow problems and the belt-tightening operation by Renault, combined with the sudden turnaround by Volvo corporate management with regards to their smaller innovative plants in Kalmar and Uddevalla. Volvo management thought that the rationalization which was necessitated by the squeeze on the European car market, could best be found in a concentration of productive capacity in the larger plants in Sweden and Belgium.⁴

Yet, while this explanation provides us with the structural background parameters, it does not allow us to appreciate the full story. Our treatment of the Uddevalla closure starts where the other stories come to an end, and tries to explain why the counterfactual ‘What if the unions had put up a fight to keep Uddevalla open?’ never occurred. Given the power of the unions in the Volvo firm as a whole, it is very likely that this would have created such a different configuration that Volvo would have been forced to re-evaluate its decision and simply look for other ways out of the crisis. In this counterfactual world the story might have been very different and Uddevalla’s closure may not have been as over determined as it is now. A different outcome was therefore possible and the key is to understand why that did not happen. Part of the answer is obviously to be found in the events surrounding the closure decision that others in this volume are considerably better-placed than we are to deal with; part, however, is also hidden in the role of the union in the Uddevalla project group in the mid-1980s.

Metall project members, both from the Gothenburg union district and from the Stockholm central leadership, played an important role in the discussions that led toward Uddevalla. Initially their demands were rather conventional but, once they found their momentum, the union people in the project group pushed the project considerably into new areas.

However, while Metall people played such an important role, other issues, at that point seemingly marginal to the project, were left untouched in the development process. The most important one of these, if judged by the final outcome, was the influence of the project group on corporate decisions. Throughout, there was no discussion of what cars to build in Uddevalla – originally the low-end 240 as well as the high-end 940 were to be built there; then that changed and, eventually only the most expensive model was built in Uddevalla. Similarly, there were no contacts with project groups that were working on a new Volvo car, the currently marketed 850, and existing models were never re-engineered to match the learning and production process at the Uddevalla plant. Also, from a reconstruction of the development process, it appears that strategic linkages between the Uddevalla union reps and the Volvo corporate board union reps (but this seems to be true to some extent for management as well), were virtually non-existent. All of this suggests that the Uddevalla project group – and the unionists in it – acted in an autonomous manner, detached from their parent organizations.⁵

Why did the union leave these and other strategic issues untouched? From interviews with the people involved, two sets of answers emerge, and both help us understand at least in part what happened. The first one is the ‘official Metall story’. According to this view of things, any involvement with other issues was simply not deemed necessary at that time. The group concentrated on how to make a car, because, once in operation, it believed, production would be intrinsically so flexible that any changes in the demand mix would be easy to meet. The other issues were, in this view, not a problem and if strategic issues became important, the co-determination law framework would provide the union with the resources it needed. The issues were never discussed, in other words, because they were no issues.

But unions do not always do what they say they do. That is the starting point of the second argument, which digs somewhat deeper, puts the first plausible but limited point in larger perspective, and complements it: internal union politics blocked the active participation of the local Uddevalla people into these other, non-traditional areas. In order to understand this, a short review into the structure of Swedish unions is necessary.

Swedish unions operate at three levels of the economy simultaneously: the national economy, the industrial branch and the individual firm/plant. (In the case of large corporations such as Volvo, there is a fourth level, the corporate,

inter-plant level.) Territorially, the unions have so-called 'groups', regional union bodies (districts), that consist of the plant/firm-level unions within one region, the so-called 'workplace clubs'. (Kjellberg 1983 and 1992)

Inside the Gothenburg Metall union district – the regional union body that organizes the workers in the main Torslanda plant (ca. 10,000 workers) and the small Uddevalla plant (ca. 1,000 workers) – there have always been two large camps with regards to Uddevalla. One side supported the project because they were convinced about the necessity for the union to play an active role in shaping companies and work in Sweden. The other group, mainly consisting of more traditional unionists, were very good at the conventional type of union work, and therefore did not appreciate nor like the Uddevalla-type ventures into new fields, or understood what the union role would be in this new production and management system. This latter group was embodied in the Torslanda local president, who attempted to restrain the local union people involved in the Uddevalla project group several times, wanted to impose the 20 minute ceiling on the task cycle as the official union line, was unable to envision a car factory without lines, and denied the union people the authority to discuss other, wider-ranging strategic issues.

The reasons why the local union people were, in the end, able to push through their program, is a fine illustration of the role of surprises and contingencies in the development of Uddevalla. Whereas the Torslanda Metall president was easily among the most important and powerful people in the union not only in Gothenburg but in all of Sweden, one of the Metall people in the project group was his 'political party counterpart', the chair of the SAP clubs in the Volvo concern (the Social-Democratic Party). He could and did use this position as an independent power basis in the struggle over the direction of Uddevalla and managed to prevail at least in terms of setting the signposts for the union's participation in the project.⁶

As long as Volvo's company results were good – and they were very good in the mid-1980s – the 'defeat' over Uddevalla was acceptable to even the hardest-nosed opponents of the project, in union as well as management circles. But when the situation soured, the old animosities resurfaced. The moment the general over capacity crisis in the European automobile industry hit Volvo, however, the initial coziness was over and the real problems emerged. In 1988, a rift between different management factions had already become clear. Official unemployment in Sweden is currently some 9%-factoring in those workers who are currently in training programs, more or less the average of unemployment in Europe and a straightforward disaster in a country that has known unemployment rates of 2–3% for most of the last thirty years.

Yet the trouble runs deeper than a management cycle. It starts with the

Renault-Volvo alliance in the mid-1980s. In the summer of 1992, a French consultant wrote, in a report to his government (Renault is, as of the day of this writing, still a Régie) that the deal with Volvo was bad for Renault and that Uddevalla was an especially troubling cost factor in the alliance.⁷ Volvo also posted, in the same period that this report was made public, its second year of big losses, and the company's situation kept getting worse: by the second half of 1992, Volvo was losing something of the order of 10,000 Swedish Kronor (at that time around \$2,500) on every car it sold. In the alliance with Volvo, Renault footed that bill.⁸

Renault thus forces Volvo to shrink. For a number of reasons, the Volvo plants outside Sweden are immune to calls for capacity reduction. The plant in Born, NL is a joint venture between Volvo, Mitsubishi and the Dutch state, and the Ghent plant in Belgium is not only the corporation's flagship in terms of productivity and quality, but also too important in strategic terms, located in the heart of the EEC.⁹ Sweden is therefore the place where it will all happen. And here the old tension between the Uddevalla and the Torslanda local reappears. Neither of the two wants to lose their own members. Yet the Torslanda union is by far the biggest local in Volvo, and this position gives it the power to prevail over the smaller locals in the Volvo concern, especially over Uddevalla, which is technically in the same union district as Torslanda. A defensive coalition of Metall unionists in the Torslanda local, unhappy with Uddevalla anyway, who want to safeguard jobs in the plant in Gothenburg, and 'traditionalists' in management, who did not see the need for Uddevalla, emerged. The decision was made, and even a series of provocative opinion pieces from industrial sociologists and other experts in one of Sweden's leading newspapers, *Dagens Nyheter*, in the spring of 1993 on the plant closing was unable to change Volvo's mind. 'Dissident' consultants, who offered their services to the union in case an alternative plan was drawn, were politely told that their services were not appreciated because the Volvo union agreed with the decision, and it was not up to the central union to meddle in local affairs anyway.¹⁰ The national union, the local, and management simply refused to discuss the issue in public, arguing that it was an internal Volvo affair.

Volvo's crisis thus resuscitated long-standing divisions within both management and labor unions, and sealed Uddevalla's fate. What mattered was not the plant's performance – which management later admitted was not the primary reason for the closure – but the way it was never able to muster the political support it needed. And the reason it could never muster the support is in large part connected to its exceptional nature; that is one of the central causes for the tension between the locals in Torslanda and in Uddevalla. Both locals have vastly different ideas of what unions in the 1990s ought to look like, which explains why Uddevalla never had a broad political basis

inside the union (in Volvo, not among the staff in Stockholm). Once the circumstances had pitted one local against another, the stronger one won.

2.2 Saturn: GM's New Prodigy

Today, only a few years after its initial launching, General Motor's new Saturn Corporation is a remarkable success in the marketplace. The car is highly innovative in design and technology: Saturn uses a space frame, poly-mer panels, water based paint, an aluminum lost foam cast engine and trans-mission, and moving platforms carry and adjust the height of the vehicles during assembly. Most remarkable, perhaps, is the record on quality. Two years after the first car came off the line, Saturn received higher ratings from consumers than any other U.S. domestic car line in initial vehicle quality, in satisfaction after one year of ownership, and in service.¹¹ The hiring of a third crew in June 1993 allowed the plant to fully utilize its capacity. It also brought total employment to 8000, of which 6000 are members of the bargaining unit. While GM continues to close plants, an expansion of Saturn is being planned.

The United Auto Workers national union played a crucial role in the development of Saturn. Without the active participation of the UAW at the national level in the planning and design stages, Saturn in its present form could not have been created by GM on its own. In 1983, responding to a loss in market share, General Motors management and the UAW national union formed a joint labor-management committee to study the feasibility of building a small car in the United States of America under new production and employment relationships. After an international evaluation of world class manufacturing practices, the committee identified a set of principles for organizing Saturn:

- Treat all employees as fixed assets and invest heavily in their training and skill development;
- Organize based on groups, with self-managed work teams as the basic unit;
- Openly share information including financial data;
- Make decisions through consensus with the UAW as a full partner;
- Decision making authority will be focused at the level of the organization where the necessary knowledge resides and where implementation will take place;
- Minimize job classifications;
- Union and management will jointly administer recruitment and selection. Seniority will not be the basis for selection;
- The technical and social organization will be integrated;
- The organization will require fewer full time UAW officials and labor relations personnel to administer the contract than would be required

- in a GM organization of similar size;
- Compensation will include a contingent portion based on performance in quality, cost, delivery and value to the customer.¹²

In 1985 these principles were codified in a Memorandum of Agreement, which served as the first Saturn contract between the UAW and General Motors. The contract, however, differs significantly from the voluminous agreements traditionally negotiated between GM and the UAW. Only 28 pages in length it is viewed as a ‘living agreement’ subject to modification by the parties as needs arise, with the focus on problem solving, shared decision-making and joint authority at its core.

Conflicts and grievances have not disappeared, but have been redefined as joint problems, to be solved through consensus rather than elaborated adversarial procedures. By integrating workers’ knowledge and input, and the union’s authority into the process early on, problems can frequently be dealt with before they reach a level where the grievance procedure is the only way out.

Through the agreement the national union and GM established several levels of formal joint union-management committees. Committees or *Decision Rings* were created at each of the three plants – assembly, engine, and body. They were also organized across the entire manufacturing complex and at the strategic level of the Saturn corporation. These committees meet weekly and reach decisions by consensus. They deal with long and short term planning and ‘determine the resources needed by the Work Units (see below)’¹³ The strategic corporate-level joint labor-management committee

undertake(s) strategic business planning necessary to assure the long-term viability of the enterprise, and will be responsive to the needs of the market place ... It is charged with creating the environment, facilities, tools, education and support systems which will enable Saturn Members to perform their responsibilities.¹⁴

At the shop-floor, self-directed teams organize production. Unlike many other car plants, however, the teams (or *Work Units*, as they are called in Saturn) have considerable autonomy and responsibility. These ‘selfdirected’ teams organize production scheduling, are directly responsible for quality control, safety and health, equipment maintenance, budgeting, material and inventory control, training, and many other tasks that are typically the role of supervision in most of the auto industry.¹⁵

These teams or ‘Work Units’ have between 6 and 15 members, and they elect their own leaders who remain ‘working’ members of the team. Members rotate between all of the jobs in the team and receive extensive technical training as well as the skills needed to operate as a self-directed team. The first crew of production workers hired into Saturn had between 350 and 700

hours of training before they built a car. This already extensive commitment to training, which most likely makes Saturn workers on average among the most highly-trained in the high volume segment of the car industry, was expanded in 1991, when, during contract renewal talks the local union proposed separating the risk and reward portions of the compensation and tying the risk portion to a training goal of five percent of total working hours (92 hrs) per year for each employee.

The self-directed team structure has implications for task cycles. At the team's discretion, the cycles vary anywhere between the one minute cycle that is the standard in the industry – in which every worker deals with one small set of tasks on every car – to considerably longer cycles, even up to six minutes – whereby one worker will finish all the jobs which his or her team is responsible for, then skips five cars and moves on to the first to begin a new cycle.

Teams interrelated by vicinity, sub-assembly or similar technology, are grouped together at a higher level in *Modules*. Usually, five to seven teams totalling approximately 100 members, constitute a module. Each module has two advisors who replace the supervisors in traditional GM plants. The module advisors' task is to provide expertise, leadership and advice to the teams and therefore is the Saturn equivalent to what would be middle management in other plants.

While self-managed teams allow UAW team members significant control over their day-to-day operations, the original Saturn organizational design provided for UAW institutional involvement largely through off-line planning and information-sharing via the labor-management joint committees. However, as employees were hired and the union organized, local UAW officials recognized the need for more direct involvement in operational decision-making if the union was to fulfill the language in the agreement calling for 'full participation'. Here Saturn, already far removed from the industry standard, broke even more new ground.

Perhaps the most significant is the 'partnering' of UAW members with their management counterparts in the middle management and staff organizations. Initiated by the local union leadership in 1988, by 1993, this involves over 375 jointly selected UAW members who are partnered full-time with management in supervisory and operations middle management positions in all three plants. UAW members are also partnered in almost all off-line staff functions: maintenance, engineering, sales, service and marketing, finance, industrial engineering, quality assurance, health and safety, training, organizational development, corporate communications, and product and process development. 'Partnering' is an arrangement that goes much further than what is known in continental Europe, as co-determination. In Saturn, union partners share offices with their management counterparts and

participate equally in decision-making through a consensus process.

As a result, institutional union participation extends well beyond the off-line labor-management committees originally envisioned in the initial agreement. The union now participates 'on-line' in the day-to-day operational decision making. Management is, in Saturn, no longer simply a group of people occupying particular positions in the organization, but a set of functions and responsibilities shared by *union* represented employees with their *non-represented* partners. The local union at Saturn truly *co-manages* the business.

At the same time the local represents the stakes and equities of the workforce. In its functions and structure, and independent of the union's involvement in management, local 1853 at Saturn is a workplace union as many other in the US, whose role it is to negotiate local issues and working conditions with management, resolve grievances. The union also has retained its ability to organize strikes if necessary. The difference with other unions is that most of the conflicts that surface – many more probably in Saturn than in other firms because of the high degree of workforce involvement in decision-making – are resolved without recourse to the traditional union weapons. The local union also takes its role as an independent representative of the workforce very seriously. All the usual internal local participatory institutions are in place in the Saturn local. But there is more. Yearly, the union conducts a member-to-member survey in which the (UAW) team leaders interview each member for 45 minutes on the issues, concerns and needs that they would like to see addressed by the union. Finally, local 1853 has sought to expand the representation of the union to all employees working in the Saturn complex, including outside contractual workers.

Despite Saturn's impressive record of innovation and market success, strains do exist in the evolving partnership arrangements. As mentioned earlier, the national union played a critical role in Saturn's creation and early development, joining with GM in the joint study team and articulating the principles for organization in the 1985 Memorandum of Agreement providing the enabling language and new contractual and employment relations. Yet, over the past few years the national's involvement has been reduced. To some extent this is of course a natural development as the local parties take the initial contract language as a starting point for developing their own arrangements based on problems and needs as they arise. The partnering arrangements that lead in effect to co-management of the operation were perhaps the most dramatic example of local innovation in response to the changing needs of the corporation. Most of this was, as we suggested, not anticipated by the early work of GM and the national union.

However, the change in relationship between the local and the national union appears to be more than a natural evolution. In recent years the na-

tional seems to view Saturn not so much as a model for the future, but as an experiment that is perhaps moving in the wrong direction. (Interestingly this also has been mirrored by some ambivalence on the part of GM management toward Saturn.)

Tension has occurred in other areas as well. In the summer of 1992, for instance, public disagreements between the local leadership and the national erupted over strike strategy employed by the national and directed against GM supplier plants which also supply Saturn. Strains also grew over the level of autonomy enjoyed by the local: in advance of the 1993 GM negotiations, UAW national leadership asked that the Saturn Agreement be reopened. To some observers, this indicated that the union would like to bring Saturn back in line with the national contract pattern.

Clearly the appropriate relationship between, on one hand, a local union that departs so much from tradition in order to jointly govern and co-manage an innovative organization, and the parent national union, on the other hand, which itself planted the seeds of this innovation, has not yet been fully worked out at Saturn. New methods and relationships for producing cars are necessary for GM and the UAW to survive in the global automotive industry. Some critics, both within the UAW and within GM, argue that if GM had put its investment in Saturn into older facilities, they too would be competitive now. Often people point to NUMMI, once among the worst plants in the US, today one of the best (see Adler & Cole in this volume), with the same workforce and in the same factory as before.

Yet Saturn can provide enormous return on its investment by capturing what it learned from its innovations, and transferring this knowledge back to GM and the UAW. To date, however, this potential and the opportunities it provides, is underrealized. The continuous development of best practice models of production and organization will depend on available resources, learning models, diffusion patterns and coordination.

The national union can play a critical role in all of these activities. Moreover, the national union can also serve as a protection against corporate whip-sawing, whereby one plant competes against another, thus provoking a regressive spiral as each tries to undercut the others.

However, the local union has gained power and influence through its increased competence in strategic and operational areas, precisely the kind of expertise that is critically important to the success of modern high performance work systems. How the power of the union at Saturn is shared between the local and national will be one of the critical tests regarding Saturn's future viability as an alternative to the traditional practices of GM and the UAW. Over the long run its performance will depend on finding the right mix of local autonomy, national coordination and mutual learning.

The Saturn partnership breaks not only with the organizational arrange-

ments in other GM facilities organized by the UAW, but also with the rest of US industry which sharply separates the roles of labor and management. In its operation, the company thus explicitly challenges the logic of management prerogatives and union domains which has defined all postwar Western political economies. Investment (almost always the management of resources) was management's business, the social repercussions that of the union. In Saturn, the traditional distinction between the concerns of management and those of the union, has been completely rethought.¹⁶

2.3 Comparing Saturn and Uddevalla

At first glance, Uddevalla and Saturn do not appear to share many characteristics: they are located in different parts of the world, one is closed, the other increasingly growing, one built cars for the high end of the market, the other moderately priced mid-size cars. In short, the two are very different. Yet they share one important characteristic: both are, in their operating logic, exceptions with regard to their parent corporations because of the way they break with established patterns of firm governance. And this exceptional character is an important variable to keep in mind when evaluating both innovative organizations.

Uddevalla failed, we think, not because it was inefficient, or an incomplete plant, and not even because of a conservative management reflex in times of crisis. In our reading of the story, Uddevalla closed because it did not have a winning coalition that backed it. None of the social groups involved in the organization of manufacturing could tie their fate in an almost existential way to Uddevalla's long-term success: not the managers, not the unions and not the workers.

The first group is permanently caught in a dilemma. A self-managed production system that relies on the collective and individual skills of workers as in Uddevalla reduces the role of engineers and management in the control of production processes. However, this loss of control over the production process is off-set by the potential gains to the production system. Politics and economics thus collide, and there is, neither on economic nor on political grounds, reason to believe that the model which combines higher efficiency with a democratic redistribution of power and skills will prevail.

Labor unions have a related problem with this new production model. In recent years, we have witnessed a major re-assessment of the role that car and metal industry unions see for themselves in the organization of industry: in Sweden and Germany, for instance, they have in recent years drafted union platforms that demanded better jobs for teams of workers, and in which the labor unions would play a role in training the workers (Metall 1985; IG Metall 1991). Yet while such programmatic changes are important, the old order is still a vital point of reference. For in practice unions remain, in Sweden

as much as in other countries, the defenders of the semi-skilled workers, until they know how to translate the new union programs systematically into practice. And here the problems of Uddevalla appear: the semi-skilled worker is exactly the group that disappeared in Uddevalla.

Moreover, despite the attempts by the Metalworkers and Autoworkers unions in Sweden, Europe and the US, to re-think their role in the economy, unions have not yet ventured very far into the new field of production organization. Whatever promise Uddevalla may have held for the labor movement in the long run, its development was always blocked by the short-term uncertainties that it created, as it called into question a series of assumptions about the distribution of power and authority in the workplace upon which the postwar union model was built and that proves with amazing regularity how solidly entrenched it is.

The workers, then. It may be very hard to substantiate this, but there is some evidence and logic that suggests that workers only appreciate changes à la Uddevalla *after* they worked in them, and it is only then that their support can be mustered for these new forms of work organization, that are still distant. It is defiantly difficult, presumably impossible, to organize around the promise of reflective work and organization as in Uddevalla. With none of the strategic actors capable of linking their interests to the survival of the plant, Uddevalla's fate was sealed.

How does this general point about the closure of Uddevalla inform us about Saturn? It forces us to see that economic success is only one variable in a giant equation. Saturn is very successful; so was Uddevalla. But GM and Volvo are having serious trouble surviving in today's competitive global car industry. Uddevalla was safe as long as Volvo was successful. The plans for Uddevalla emerged when Volvo was among the most profitable car companies in the world, and were implemented in order to build more Volvos. Volvo's crisis in the last four years, which at some point even culminated in merger plans with Renault (with a minority stake for Volvo), quickly exacted a victim: Uddevalla, the 'swan among the ducks', in Ellegård's words.

GM and Saturn do not have the same relationship and any linear transposition of scenarios from one case to the next would be foolish. But the events that we analyzed for Uddevalla, combined with the information on Saturn should warn us – both the sympathetic observers and those actively involved – that in GM Saturn too, politics is an important variable in analyzing and understanding the plant's performance, now and in the future.

3. Conclusion

The history of Uddevalla and the analysis of Saturn remind us that the economy and society are really two sides of the same coin, and inseparable.

In the economy, as we have tried to demonstrate, economics may determine a lot – but not everything. Economic organizations do not operate in a social and political vacuum: they are a vital part of their environment, just as their environment is found in every aspect of their operation. Saturn and Uddevalla are perfect illustrations of the interrelationship between politics and economics. They are both economically viable operations and embody, within the confines of their national systems of industrial relations, a bold new path towards combining economic democracy and economic performance; yet they are also so different from the rest of their corporate and union environment, that friction creeps up and emphasizes the differences between the new-born and the parent.

Their exceptional character resides in the way both organizations deal with the distribution of skills, authority and with the ideas of management and workers' self-management. Today, in an era when the 'human factor', exactly what makes Saturn and Uddevalla so exceptional, is almost continually rediscovered in manufacturing processes, this minor point suddenly takes on gigantic proportions. Because, as firms and plants experiment with new modes of social organization, politics and society are re-discovered as an intricate part of industrial processes, and as potential sources of conflict.

It is important, though, to understand that plants in big corporations such as the ones we discussed here invariably face a very peculiar kind of Catch-22 situation: their existence depends in large measure on the resources the parent corporation is willing to pump into their development – and the farther removed from the standard in the parent organization, the higher the development costs. Yet exactly this makes them very vulnerable, since, almost by definition, they will differ in very important respects from the standards prevailing in the rest of the corporation that they are embedded in, while they are so dependent upon the resources of the latter. The tension between these innovative production islands and their parent corporations at the core of the analysis of this paper, is thus one of those implicit conflicts that are almost impossible to avoid, and therefore require careful management. That is what makes this analysis relevant for other organizations as well: as more and more companies embark on new and bold paths toward competitiveness, and rediscover human resources and labor relations as strategic variables in this process, the way organizations are able to deal with corporate frictions of the kind we describe in this paper will become ever more important.

This suggests a number of questions, addressed directly at Saturn. What can an analysis of Uddevalla's demise teach Saturn and General Motors about the appropriate mix of central coordination and local autonomy? How to keep the initiators in the corporate or national union engaged in on-going innovation? How should the local and national unions share power to allow

for the innovation, flexibility, responsiveness and ownership necessary for local co-management and joint governance, while at the same time ensuring coordinated policy, security, learning and diffusion of best practices at the national level? We think that a careful analysis of Uddevalla – and other innovative cases where they exist – will actually benefit the innovators in the American automobile industry, on the union as well as the management side. It may have been a different country, and (by now) a long time ago, but what happened in Uddevalla is still relevant.

Finally, we want to pre-empt accusations of naive optimism: however innovative, more democratic and efficient workplaces such as Saturn and Uddevalla are, many political and economic disparities that are removed from the world inside the factory, remain once we step outside. For, as the Uddevalla tragedy makes painfully clear, corporate management, not the workers, ultimately control group decision-making and its purse strings. Crucial corporate decisions, such as market and product strategy, remain far outside the reach of local management, labor unions and workers. In Uddevalla, such invisible disparities may not have mattered a lot in the initial stages and the growth phase of the project; however, as we discussed above, without a ‘special’ product, the plant was an obvious first victim of the cuts in Volvo. In the case of Saturn, product and marketing decisions are not made entirely independently either, but must still be coordinated with the larger GM corporate strategy. In sum, while within Saturn and Uddevalla decision-making has been decentralized and workers empowered far beyond what one accepts as the norm in the industry, key aspects remain beyond the reach of workers and unions.

This may ultimately well be the most profound weakness of the ‘experimental’ islands: as long as their future is ultimately decided elsewhere, no one can ever be certain about their long-term viability. In the face of tragedies like Uddevalla, trade unionists looking for models of innovation can sometimes show some ambivalence in their allegiance to such changes.

Acknowledgements

The material on Saturn presented in this paper is based on research conducted jointly by Thomas Kochan, MIT, Michael Bennett, UAW Local Union 1853, and Saul Rubinstein, MIT. Funds were provided by the *MIT Leaders for Manufacturing Program* and the *MIT International Motor Vehicle Program*. The research on Uddevalla was conducted by Bob Hancké and was funded by the *Harman Program in Technology, Public Policy and Human Development* of the Kennedy School of Government at Harvard University. We wish to express our appreciation to Harvey Brooks and Michael Maccoby for their help in improving this paper. The views expressed, however, should only be attributed to the authors.

References

- Paul S. Adler & Robert E. Cole (1994), 'Rejoinder' *Sloan Management Review*, Vol.35, no. 2, (Winter)
- Christian Berggren (1990), *Det Nya Bilarbetet* (Lund:Arkiv)
- (1994), 'NUMMI vs. Uddevalla' *Sloan Management Review*, Vol.35, no. 2, (Winter)
- Kajsa Ellegård (1989a), *Akrobatik i Tidens Väv* (Gothenburg: Department of Human Geography of the University of Gothenburg)
- (1989b), *Metalls Medverkan i Projekteringen av Volvos Uddevallafabrik* (Stockholm: Metallarbetareförbundet)
- Michael Dertouzos et al. (1989), *Made in America* (New York: Harper)
- IG Metall (1991), *Tarifreform 2000* (Frankfurt: IG Metall)
- Ulrich Jürgens et al.(1989), *Moderne Zeiten in der Automobilfabrik* (Berlin: Springer Verlag)
- Harry Katz (1985), *Shifting Gears* (Cambridge MA: MIT Press)
- Anders Kjellberg, *Facklig Organisering i Tolv Länder* (Lund: Arkiv 1983)
- (1992), 'XX' in Richard Hyman and Ferner, *Industrial Relations in Europe* (London: Allen & Unwin)
- Thomas Kochan et al.(1986), *The Transformation of American Industrial Relations* (New York: Basic Books)
- Metall (1985), *Rewarding Work* (Stockholm: Arbetsmiljöfonden)
- Michael Piore & Charles Sabel (1984), *The Second Industrial Divide* (New York: Basic Books)
- Charles Sabel (1982), *Work and Politics* (New York: Cambridge University Press)
- Wolfgang Streeck (1991), 'The Institutional Conditions for Diversified Quality Production' in Egon Matzner & Wolfgang Streeck (eds.) *Beyond Keynesianism* (Aldershot: Elgar)
- Lowell Turner (1991), *Democracy at Work* (Ithaca NY: Cornell University Press)
- James Womack et al. (1990), *The Machine that Changed the World* (New York: Harper and Row)

Notes

1. Data were gathered through interviews with GM Human Resource Management from the Saginaw and Inland Fisher Guide Divisions, December 1992.
2. Interview with Wilfred Wilms, UCLA, December 11, 1992.
3. The chapter by Christian Berggren provides more details; see also Berggren 1994, and Adler and Cole 1994 for a discussion of the economic performance of the plant. The conclusion of this debate appears to be that Uddevalla was indeed probably sufficiently productive, but perhaps in the wrong sector: the car industry produces, after all, still primarily standardized products on a large scale.
4. See the chapters by Williams et al., Berggren and Sandberg in this volume.

5. The chapter by Ellegård provides the background; see also Ellegård 1989a and 1989b.
6. Most of this information on the internal union politics was gathered in the spring of 1993 during interviews with (central and local) Metall members who participated in the project group, local union people in Uddevalla and Uddevalla management.
7. The Financial Times printed a short article on the report in the summer of 1992: Financial Times 9 July 1992.
8. In December 1993, a coup in Volvo's board ousted Pehr Gyllenhammar, the company president, and froze the merger plans. By early March 1994, the two companies were untangling the ties between them and the merger plans had definitely been aborted. The decision not to merge is rather irrelevant for the purposes of this paper, since the events we deal with here took place when the alliance between the two was very strong. There is, however, one detail worth mentioning. The same manager was responsible for Uddevalla's closure and for the failed merger: Sören Gyll, the current president of the company.
9. The chapter by Dankbaar gives details on the Dutch plant and the chapter by Huys on the plant in Belgium.
10. This was said with so many words by a leading Metall official in a reply to the criticism in the newspaper of LO, the blue-collar labor union confederation (see 'Metall går till motangrepp för kritiken om Uddevallafabriken' (Metall starts a counteroffensive over the criticism on the Uddevalla factory) in *LO-tidningen* no 8, March 19, 1993)
11. JD Power 1992 Customer Satisfaction Index. Saturn Ranked highest among all US (transplants included) car lines and third overall behind Lexus and Infiniti.
12. These principles can be found in the *Memorandum of Agreement*, published by the Saturn Corporation 1985.
13. *Memorandum of Agreement*, Saturn Corporation, 1985.
14. *Memorandum of Agreement*, Saturn Corporation, 1985.
15. *Memorandum of Agreement*, Saturn Corporation, 1985.
16. Saturn also has the potential to break new ground in law and public policy. The US Supreme Court (in *NLRB v. Yeshiva University*, 444 US 672, 1980) ruled in 1980 that employees doing managerial work were not covered under the National Labor Relations Act, and thus did not have rights to collective bargaining and the protection of a labor union. The institutional arrangements created at Saturn by the members of the UAW local union and their non-represented partners call into question the adversarial assumptions behind labor relations in current law.

Group work and the reception of Uddevalla in German car industry

Ulrich Jürgens

If the routine of the workman's movement is broken he must inevitably call his brain into action to find the best means of bridging his troubles and must lose some time in devising and executing his unusual line of procedure ... The minute division of labour allowed the worker to perform his unvaried operation with the least possible expenditure of will-power and hands with the least brain fatigue. (Horace L. Arnold, Fay L. Faurote: *Ford Methods and the Ford Shops* (1915), New York: Arno 1972, p. 275, p. 245)

1. At odds with MIT's lean production message

The German as well as the Swedish variants of work organization were treated with harsh critique by the authors of the MIT study 'The Machine that Changed the World' (Womack et al, 1990; German edition 1991). Get rid of it the sooner the better, was the advice of the authors referring to what they regard as the base principle of the German and Swedish models: (neo-)craftmanship.

The MIT critique was very influential, indeed, in a change of directions which has taken place in the debate and implementation of new forms of work in the two countries. Up to the late 1980s these seemed to follow a specific national trajectory of work organization based on a tradition of jointness between labour and capital and responding to the specific labour market conditions. In Germany during the 1970s and 1980s the Swedish debate on new forms of work and, specifically, Volvo's experiments with work organization in its Kalmar and Uddevalla plants were often referred to as a model for future oriented work structures. In the German production concept the skilled workers played a central role indeed. This characteristic element of the German model was highlighted by an account of a plant visit

made by the MIT authors. 'When we visited this plant', the authors recall,

... we didn't have to go far to find the basic problem: a widespread conviction among managers and workers that they were craftsmen. At the end of the assembly line was an enormous rework and rectification area, where armies of technicians in white laboratory jackets labored to bring the finished vehicles up to the company's fabled quality standard. We found that a third of the total effort involved in assembly occurred in this area. In other words, the German plant was spending more effort on fixing the problems it had just created than the Japanese plant required to make a nearly perfect car the first time. (Womack et al. 1990, p. 90f.)

The *Financial Times* disclosed that this was a Mercedes-Benz plant (Done, 1991). In the Swedish case the authors do not reveal the empirical basis of their negative evaluation. After a short description of the process layout at Uddevalla they conclude:

We are very sceptical that this form of organization can ever be as challenging or fulfilling as lean production. Simply bolting and screwing together a large number of parts in a long cycle rather than a small number in a short cycle is a very limited vision of job enrichment. The real satisfaction presumably comes in reworking and adjusting every little part so that it fits properly. In the properly organized lean-production system, this activity is totally unnecessary. (Womack et al. 1990, p. 102)

Here we find the same critique as in the case of Mercedes Benz' plant. The Uddevalla system, even worse, is moving intentionally in the 'wrong' direction as it does not aim towards further automation, instead focusing on handcraft production:

Thus by the end of the century we expect that lean-assembly plants will be populated almost entirely by highly skilled problem solvers whose task will be to think continuously of ways to make the system run more smoothly and productively. The great flaw of neocraftmanship is that it will never reach this goal, since it aspires to go in the other direction, back toward an era of handcrafting as an end in itself. (op. cit.)

The authors did not pay any need to the differences in 'craftmanship' in Germany and Sweden. However, there is a considerable difference and this difference played an important role for the German reception of Uddevalla's work organization.

2. The shaping of the debate on new forms of work in Germany

The German debate on group work started in the 1970s. There were two different and partially contradictory driving forces. One was a government sponsored policy programme for the 'humanization of work' and corresponding demands by the unions and the workers' interests representations to improve working conditions. The other was the automation strategy of the companies which was developed by the end of the 1970s and materialized in the first half of the 1980s.

Within the framework of the 'humanization of work' programme several group work experiments were initiated. The main thrust of this programme, however, was on ergonomical aspects to reduce stress and strain at the workplace. With regard to assembly line work, the IG Metall successfully put forward the demand to rule out work cycle times below 1.5 minutes in some regional master agreements. The demand reflected a growing critique of paced fragmented work which spilled over from the shop-floor rebellion at the General Motors plant in Lordstown, USA, and of the debate on new forms of work in Sweden (cf. Kern 1979, p. 193ff.). The conviction became widespread in Germany that the days of the classical assembly line were coming to an end, and that alternative means to organize the work process had to be found.

A major driving force for this orientation were labour market considerations. The government had decided to end the policy of 'guest worker' imports and thus companies could no longer count on a supply of labour willing to fill in jobs which were unattractive to Germans. And here the automation strategy came into play. A vision of future oriented work structures evolved where the direct production jobs became substituted by new technology and skilled labour taking over the task of running the high technology equipment. This went along with a vision of 'computer integrated manufacturing' aiming at high degrees of automation even in areas like final assembly and small-batch production, where until then human labour had prevailed. The skilled worker was regarded as the key figure in the modernized plants and it was thought that high-tech work structures would again give Germany the competitive edge.

The notion of 'skilled work' has a clear meaning in the German context. It relates to the task profile of the 'Facharbeiter' who has completed a three-and-a-half-years' apprenticeship in the so-called 'dual system'. During this time the apprentice stays half a week in a public school for vocational training and the rest of the week at the employer for on-the-job or off-the-job training. The apprentice has a temporary employment contract only, after finishing the apprenticeship it is up to the employer whether he or she will be

taken on as a regular employee. And it is an open question whether this will be a skilled worker's job or not. Thus, a skilled worker could end up with a job classified as unskilled or semi-skilled i.e., on an assembly line. And indeed this was a growing tendency due to the 'qualification offensive' which began by the end of the 1970s. A broad policy consensus had emerged that every youth should have a right to enter an apprenticeship after finishing school. The demand for skilled work became less and less a determining factor for the companies' intake of apprentices. But after finishing the apprenticeship, finding a skilled worker's job became increasingly difficult. In order not to have to dismiss these young qualified workers they were offered jobs in direct production beneath their skills.¹ But in view of future automation measures which were seen as the general trend, production management saw these employees as an asset which they tried to hoard.

As a consequence of this development, the share of 'Facharbeiter' among the direct production personnel increased from year to year. The skilled workers at the Mercedes-Benz plant mentioned in the MIT study, were an example of this development. Here the job of re-working and rectifying defects on the line is also classified as non-skilled work. But for reasons we have just cited, these jobs were filled by 'Facharbeiter' and because of their skill potentials production management probably was proud to point this out to the researchers. But the fact that these skilled workers were deployed on this job was not due to their perception as 'craftsmen's jobs'.

The main rationale to hoard Facharbeiter for non-skilled jobs at the beginning of the 1980s was the perspective of further automation. Accordingly, the Anlagenführer (equipment controller) became the new paradigm of industrial work in the debate initiated by the sociologists Kern and Schumann in their book called: 'The End of the Division of Labour' (1984).² The Anlagenführer is a person who ideally would be a Facharbeiter with further training for running high-tech production equipment and managing support work. The Anlagenführer also was at the centre of the new debate on group work in high-technology areas in the 1980s. The question here was how to deal with the remaining manual jobs in these areas such as filling magazines, taking off finished parts etc., jobs which were regarded as 'residual' in regard to the trajectory of future automation and which were clearly dequalified compared to most of the jobs which were substituted by the automation. The equipment controller was regarded as the natural leader of a team responsible for running the equipment.³

The debate on group work or manual assembly jobs had come to a dead end by the beginning of the 1980s. One project inspired by the Swedish discussion and carried out in the context of humanization of work programme, particularly, contributed to scepticism towards group work on the side of management, as well as, the union. In this highly touted project, group work

was introduced in a section of assembly operations at Volkswagen's engine plant in Salzgitter. The group work experiment started in 1975 involving 28 workers in total. Four groups were assigned the task of carrying out the complete assembly of the engine. In contrast to the one-minute work cycle on the conventional assembly line, work stations had been set up with a labour content of around 45 minutes per station (four stations per group). The groups were given additional responsibility for material transport, engine testing, and repair. Job allocation and rotation schemes were to be decided by the groups. The groups could regulate their own internal affairs, they elected their own group spokes(wo)men (Volkswagen/Technische Hochschule Darmstadt/Eidgenössische Technische Hochschule Zürich 1980).

It turned out that the surrounding organization was not prepared to accept the change dynamics set free by this experiment. The self-assertiveness of the group speakers were regarded as threatening by the works council and shop steward (Vertrauensleute) system and management regarded demands for wage adjustments as threatening to its overall wage structure. In the end, the group work section was closed down in 1977. On the basis of economic data which were never published and remained controversial,⁴ the company argued that this kind of work organization may be suitable for low-volume, small-lot production but not for mass production. 'Not suited for mass production' hence became the standard argument against a transfer of the Swedish experiments into German car plants.

By the end of the 1980s, German car manufacturers seemed to follow a specific model for production organization. Table 1 summarizes the characteristic traits in comparison to what might be called the 'Swedish' and the 'Japanese' models at least as they were referred to in the general debate about future oriented work structures.

At the center of the 'German model' is the skilled worker and a specific understanding of skilled work as a 'profession'. This understanding includes several features: interest in the work, a willingness to accept comprehensive responsibility (also crossing over the borders of one's own task area), and a large degree of self-regulation in carrying out the work. This model presupposes a 'qualification offensive', above and beyond the direct company needs for skilled workers, which in turn is dependent on institutions and politics of vocational training. With this we are referring to the societal prerequisites for a specific form of labour regulation as they exist in the educational system of the Federal Republic of Germany. It is clear that the model of skilled-worker-centered work regulation is especially important for modern technology management. The general expectation is that future work structures will be characterized by qualified labour, uncoupled from the production cycle and the rhythm of the machines. Uncoupling work from the flow of production is the prerequisite for a type of labour with increased

Table 1: Models for production organization

<i>Swedish</i>	<i>German</i>	<i>Japanese</i>
semi-skilled workers with high initial training (quasi-apprenticeship)	skilled worker deployed on direct production jobs after full apprenticeship	semi-skilled workers with generally high starting qualifications
work totally uncoupled from the production cycle	work (partially) uncoupled from the production cycle	work tied to the production cycle
wholistic tasks with long work cycles (> one hour)	job enlargement with work cycles below one hour	highly repetitive work; cycle times around one minute on the assembly lines, around five minutes in the machining areas where multi-machine work is the norm
homogenous groups	mixed teams of 'specialists'	homogenous groups
high partial autonomy for teams through process layout	little partial autonomy for teams through automation and module production	no partial autonomy for the teams through JIT design
de-hierarchization with elected speaker and self regulation of group affairs	controversial role of group speaker/leader and of degree of self regulation	strong hierarchical structures, group leader appointed by management, no group self regulation

possibilities for self-regulation and with increased responsibility, i.e. the 'Facharbeiter'. With this goes an enlargement and enrichment of the work content but clearly below the levels of the Swedish model. The future-oriented concepts within the German model also aim at establishing production teams, but more in the sense of teams of 'specialists' of different pay and qualification levels. Teams have less leeway in organizing their work due to requirements of the technology and production control. Finally, the freedom of the teams to elect its speakers and self-regulate its own affairs appears more controversial between the social partners with different solutions at the various local sites.

The Japanese model also gives a central role to skilled labour, though not in the sense of the 'Facharbeiter' who has time-sovereignty in her or his work. Rather, ideal-typical for all Japanese models is self-regulation under the pressure of the assembly line and the production pace (for the more recent development, particularly the case of Toyota's new assembly plant in Kyushu; cf. Shimizu in this book). In the Japanese automobile industry, the work group is the starting point for the flexibilization of labour deployment and for the qualification of the workers. In stark contrast to the Swedish model, the teams have little autonomy in organizing the work process due to the just-in-time principle of production control and there is no democratic system of regulating teams internal affairs and of electing a team speaker.

3. Reception of Uddevalla

Against the background of the negative evaluation of the Swedish inspired group-work experiments in the 1970s (for other group-work experiments see Altmann et al., 1981), German observers were quite surprised when Volvo revealed its plans for Uddevalla. At that time, in the mid 1980s, the German trajectory towards new forms of work seemed to have reached its limit, however, and there was a new openness to new production concepts developed elsewhere. It had turned out that the automation strategy did not pay off economically. The downtime of the equipment was much higher and the model-mix/change-over flexibility lower than expected. It became clear that during the 1990s, at least for assembly operations, technology would not play the dominant role and, *nolens volens*, 'human centered' work organization had to receive more attention.

In fact, two different strategies had been followed by the German companies in restructuring assembly operations in the first half of the 1980s (cf. Jürgens, Malsch, Dohse 1993, p. 345ff.). One was the outright automation strategy with the most famous example of Volkswagen's building 54 where about 30 % of final assembly operations were automated. The other strategy was based on the concept of modular production, aiming at a shortening of the main assembly line by creating subassembly areas where product modules were built and then transferred to the main line. Examples would be the subassembly of doors, of the instrument panel, of the wiring harness system, of transaxles etc. Preferably the modules taken off the main line would encompass those operations where the model mix had caused most problems in terms of differing labour content and line balancing. The new subassembly areas were seen as experimental ground for new forms of work organization in many cases. Thus for instance, at Opel's Bochum plant a door and the instrument panel (cockpit) were assembled in a stationary location with individual work cycles ranging from 15 minutes to 45 minutes.

After finishing the operation, automatically guided vehicles carried the part forward to the next stage. This process layout was regarded as well suited for group work and first approaches were made in this direction (cf. Jürgens et al., 1993, p. 362). In two respects parallels to the Swedish group work development could be seen: first, in the abolishment of the assembly line and the creation of stationary workplaces (some module areas, however, also were organized as assembly-line work) and second, in the lengthening of the work cycle. But lengthening the work cycle was not so much driven by humanization of work considerations as by the need to cope with model-mix variation. Thus the average length of the individual work cycle in the cockpit area at Opel Bochum's plant was not much more than five minutes but the maximum (highest option content) cycle was more than 15 minutes.

By the mid-eighties, according to research carried out by the author on the introduction of new forms of work in the German car industry, production planners believed that a further job enlargement and lengthening of the work cycle up to 15 minutes average was to be expected. In some cases the optimum was set a bit higher, but in general a labour content between 15 and 45 minutes was regarded as feasible and desirable by the practitioners (Jürgens et al., 1993, p. 349). The increasing share of skilled workers among the direct production workers was seen as one factor which would make this lengthening possible and, for reasons of job satisfaction, also necessary.

There was no attempt to follow the Swedish trajectory towards full car assembly with individual work cycles of two hours up to eight hours anywhere in the German car industry. In fact, the essence of the Uddevalla concept, the principles of 'reflexive production' (cf. the contributions of Ellegård, Engström, Medbo and Nilsson in this book; cf. also Ellegård et al., 1992) was not understood. There was a widespread consensus that work cycles of one to two minutes length and thus highly fragmented and repetitive work should be overcome in modern assembly plants. But the rationale of assessing work cycles was still the search of the optimum between routine and habituation on the one hand and motivational considerations of job challenge and meaningfulness on the other hand. The difference between the one minute cycle and the eight hour cycle was seen in terms of linear extension, not in terms of a paradigm shift.

Three aspects of the Uddevalla production concept were particularly highlighted when introduced into a German context:

1. The fact that a factory was designed to support group work explicitly and to do away with the assembly line process type altogether.
2. The wholistic work tasks and long individual work cycles and thus the attempt to make car assembly work meaningful to its workers again.
3. The long initial training of assembly line workers and thus the re-skilling of assembly line work.

(Budde and Muster, 1990; Auer and Riegler, 1988; Pornschlegel, 1990)

Other aspects were seen as a continuation of the principles of semi-autonomous groups known from Kalmar already, even though the attempt to socially balance the composition of the group and measures to support the integration of women into production work received much attention.

The question of the length of the work cycle remained a 'hot potato' in the debate, especially the qualification target of enabling everybody to assemble a complete car. Budde and Muster stress the fact, in this context, that the work organization allows to flexibly adjust to different levels and speeds of individual qualification up from a minimum level of 120 minutes work content, which shall be reached by the initial 16-months-training period. The initial training period of 16 months is seen as a kind of assembly work apprenticeship by Budde and Muster aiming 'at a level of vocational qualification which is close if not already equal to the level of the skilled worker ('Facharbeiter')' (Budde and Muster, 1990, p. 99). Pornschlegel makes a point of reservation here:

A qualification concept for passenger car assembly is quite remarkable and it is quite exemplary in its dynamic and participatory orientation. The level of skill formation attained through this concept, however, remains far below the standards for vocational training in the metal- and electronics industries at the Federal Republic of Germany ... In so far the model Uddevalla remains in the realm of semi-skilled jobs. (Pornschlegel, 1990, p. 28)

In the fall of 1992 a union delegation from the southwest of Germany came to Sweden for a study of group work and this visit took them, of course, also to Uddevalla. The (unpublished) report points out that the target level of productivity had been reached and the average work cycle for a car and worker had reached almost two hours. 22 workers were able to assemble the complete car, among them two female workers. They were able to complete the car within 17 and 11 hours respectively. The report sees these achievements as evidence of the 'productivity potential of this type of work organization'. After describing the training system and the opportunities of further training however, the remark is made: 'Experience has shown, though that nobody has the confidence to master all tasks and only a few want to master the complete work content of car assembly. One should never forget that we are dealing here with semi-skilled workers who perform assembly operations with two hours of work content, a task profile beyond imagination in the German context.'

With no further comment the report states that in the meantime the decision to close Uddevalla had been made.

4. Learning from Uddevalla

It was not by chance that the study group visiting Sweden in fall 1992 came from Baden-Württemberg. The seeds of the Uddevalla plant had taken roots especially in this region. The regional IG Metall in the early seventies had been the first to contest the assembly line principle and Mercedes Benz, the dominant car manufacturer of the region, obviously was prepared to follow a Swedish trajectory of work organization in its modernization programme in the latter half of the 1980s. Particularly for its new plant in Rastatt, for which planning began in early 1987 and which started production in early 1992, Sweden was regarded as a model. The factory planning team was made up jointly of union and management representatives. Early suggestions, mainly from the union side, to plan for a 'line-free' process were not followed further, however, a rather complex process layout was developed based on principles of modular production. The idea was to differentiate the process layout and work organization according to different job requirements. Operations which were most effective by model-mix variation, like interior trim, wiring harness installation etc., became stationary work places with individual work cycles ranging between 70 and 120 minutes; other trim operations were to be performed on moving assembly platforms, i.e. in a modified assembly line system where work cycles vary between 20 and 25 minutes between the groups; for some operations of final assembly, like engine mounting, a shorter work cycle of around five minutes was planned. In this manner Rastatt reduced the reign of the assembly line considerably: the share of direct workers off-line on stationary work places was around 42% in 1993. But still the assembly line remains in place for a large number of operations, even though in a quite modified form and with long work cycles. Thus refined different socio-technical principles of assembly work organization were combined in this plant. What is common is the implementation of group work as the principal form of work all over the plant with elected group spokes(wo)men.

Learning from Sweden obviously has influenced the production concept realized at Mercedes-Benz in Rastatt. The three essential innovations of Uddevalla, however, were not implemented. Neither was the assembly line abolished altogether, nor were work organization and qualification systems targeted at building complete cars by small work groups introduced. The concept of skilled assembly work is common to Rastatt and Uddevalla but has a different meaning: At Rastatt almost all assembly workers have the skilled-worker ('Facharbeiter') certificate in some metal related vocational trade, whereas at Uddevalla skill formation aimed at the requirements of assembly work specifically.

The publication of the MIT auto study in German ('Die Zweite Industrielle Revolution') came as a shock and threatened to become an embarrassment for the planners and protagonists of the Rastatt plant. Here were the best practice plants particularly in Japan, all of which had conventional assembly line organization with work cycles around and even below one minute and Uddevalla even was named as the manifestation of a wrong line of development and a mistaken belief in craftsmanship. Could the announcement of Uddevalla's closure come as a surprise under these conditions? The sceptics and traditionalists among managers and unionists began to raise their voices. Had Rastatt, too, gone into the wrong direction? In April 1993 a joint management/union study group made another tour to Sweden to search for an answer. The (unpublished) report concludes somewhat consoled that the closure of Uddevalla/Kalmar was no decision against the Swedish type of group work. Continuation of the small assembly plants had become too expensive due the market situation and overcapacities, even though both plants were equal to Torslanda in terms of productivity and quality and had some additional advantages compared to the bigger plant. As a consequence, it was stated that group work should remain a central element of the companies' restructuring programme and a return to the old division of labour and work organization was ruled out; at the same time, continuous improvement principles following the model of Japanese plants should be intensified as a part of the group work particularly in optimizing the job content. The report stated that similar conclusions were arrived at Volvo's management in regard to the restructuring the Torslanda plant.

Thus, did Uddevalla's closure lead to no change of direction in Germany? One should not be misled by the statement of continuity made above. Uddevalla's closure has helped to shift the balance towards Japan-oriented concepts. The effects may be quite far-reaching. The implementation of lean production concepts is still in an early stage. Manifestations of the learning from Sweden are on the retreat in factory reality. Whereas for a decade and more, factory and work planners saw no future for the assembly lines and expected further advancements of job enrichment and enlargement, these expectations have changed fundamentally. Now we can observe a re-appraisal of the assembly line and the word is passed to rather roll-back cycle times, at least dampen the expectations of their enlargement. The assumption of a principally positive correlation between the length of the cycle time (job content) and productivity which seems to underlie the Uddevalla concept has become a focal point of critique. The curve has a different shape, argues R. Springer who is in charge of the area of work organization at Mercedes Benz: Productivity increases only to a certain point with the increase of job content. Beyond this point a further enrichment and enlargement of the job makes little economic sense, and from a certain point productivity

would drop even below the current level. Pointing at a hypothetical curve (see Figure 1) he states: 'The section of the curve P1 to P2 describes the work-organizational scope for raising productivity from a given position (P1) to its optimum level (P2). In section P2-P3 of the curve the same productivity level is reached, compared with the current position (P1), as in the section P1-P2. However, because job contents are larger here, higher wage costs and additional training costs are incurred, which, given that only the same productivity level is obtained as in P1-P2, makes it less economic. Any enrichment of job content beyond P3 leads, on the final analysis, to a decline in productivity to below the initial level and is thus to be avoided.' (Springer, 1992, p. 59)

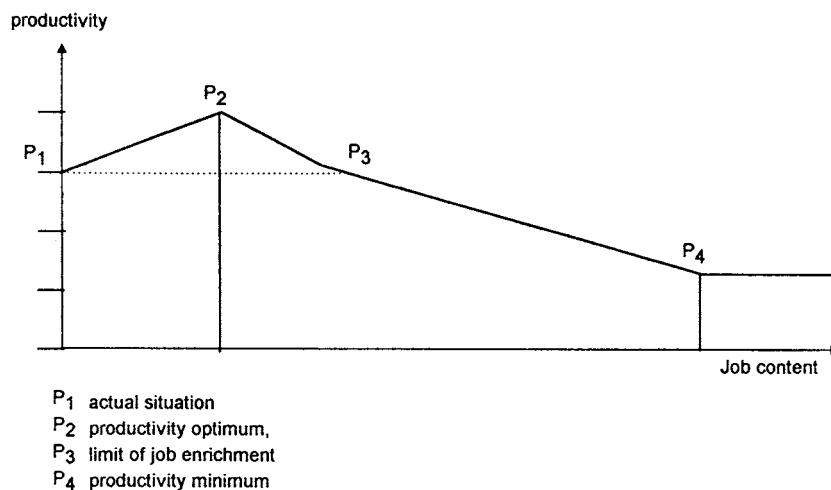

Figure 1. Productivity of manual work with varying degrees of job enrichment

Source: Springer, 1992, p.58

Most practitioners in the field of work organization in German companies would probably agree with the assumption of a productivity optimum somewhere on the curve and clearly not at the 'complete car assembly' end of it. The assumptions regarding the shape of the curve will vary depending on experience and beliefs, as well as on the size of the plant and the flexibility requirements of the production programme. Where do plant practitioners see the optimum for their trim and final assembly lines? The answer by a leading work planner of a German car manufacturer in a survey carried out by the author was 'between three and five minutes'; for stationary workplaces in module areas the answer from another company was 'around 20 minutes',

relating to job enlargement. In the case of job enrichment wage considerations play a major role: if the group is to rotate tasks the tendency is to keep a narrow range of qualification/pay levels within the group.

Summing up: It can be stated that the Swedish 'new plants' clearly had an influence on the German debate of new forms of work. There was never a real attempt to follow the full model, however, transfer considerations remained limited to certain aspects. Differences in scale of production output of German assembly plants (with daily output volumes of around 1000 cars per day, even more than 3000 cars per day in the case of Volkswagen's Wolfsburg plant) and, related to this, the stronger emphasis on automation measures are among the reasons for limiting the transfer of the Swedish concepts. The core of the Uddevalla concept, i.e. the principle of the complete car assembly by the group or even by individual workers, has never been embraced by work reformists in the German debate. There has been no awareness of the potential for continuous improvement which builds up in this kind of work environment. Taking into account that the product was not designed for this work organization and the rest of the company did not fully support nor understand the new concept, the improvements made at Uddevalla during its last year should impress anybody. After all, the investments in 'human resources' needed some time to bear fruit. Accounts of record performance of some groups and individuals in the plant showed the further potential for improvements. It is a process of improvement, however, which cannot be controlled by management. Company strategists and work planners in Germany as in Sweden obviously prefer a more controlled process to increase performance level: A bird in the hand is worth two in the bush. The Japanese concepts seem to offer an alternative way to achieve a steady and continuous process of improvement that is easier to control by management, instead of a process in leaps and bounds with much individual variation and that is highly self-regulated by the shop-floor, as could have been expected at the Uddevalla plant, if it had survived.

Notes

1. According to estimates at Mercedes Benz seven out of ten 'Facharbeiter' in the German Automobile Industry were assigned to jobs below their qualification level (Springer 1992, p.57)
2. In more recent publications, the Anlagenführer became renamed as 'System-regulierer' (systems regulator). According to data of 1992 the share of systems regulators among production workers in German car companies was 8%; it was 25% in press shops, 27% in machining operations, 6% in body shops and 1% in final assembly areas (Schumann et al. 1993, p. 17)
3. Similar concepts were discussed e.g., at Renault and Peugeot (Cohen et al., 1986) and at FIAT (Camuffo and Volpato, 1994).
4. At the end of the experiment one worker completed eight to ten engines per shift on the average, some workers even twelve engines. A study made by external consultants came to the conclusion that the group-assembly setup would pay off economically at a level of 120 to 150 engines to be completed by both groups per shift. Taking into account the continuous progress on the learning curve it could be expected that this level could easily be improved upon the groups in the future. In addition, the number of quality defects in the group area was significantly below those of the assembly line area.

References

- Altmann, N., Binkelman, P., Düll, K., Mendolia, R., Stück, H. (1981), 'Bedingungen und Probleme betrieblich initiiertes Humanisierungsmaßnahmen', *Forschungsbericht BMFT-HA 81-007*, (1) bis (4), Eggenstein-Leopoldshafen.
- Arnold, H. L., Faurote, F. L. (1972), *Ford Methods and the Ford Shops (1915)*, Arno, New York.
- Auer, P., Riegler, C. (1988), *Gruppenarbeit bei Volvo: Aktuelle Tendenzen und Hintergründe*, Stockholm.
- Budde, D., Muster, M. (1990), 'Die Alternativen kommen ins Hauptwerk zurück. Vom langen Marsch der Gruppenarbeit in die Pkw-Montagen bei Volvo' in Dieter Budde, Manfred Muster (eds.), *Mit Vollgas in den Stau – Automobilperspektiven, Unternehmensstrategien und die Perspektiven eines ökologischen Verkehrssystems*, VSA-Verlag, Hamburg, p. 88–105.
- Camuffo, A., Volpato, G. (1994), 'Making Manufacturing Lean in the Italian Automobile Industry: The Trajectory of FIAT', *Actis du Gerpisa réseau international* Nr. 10, p. 31–90.
- Cohen, Yves, Durand, J-P., Freyssenet, M., Lojkine, J., Mahieu, C. (1986), 'Travail et Automatisation dans l'Industrie Automobile', *Actis du Gerpisa réseau international* Nr. 2.
- Done, K. (1991), 'Sophistication may not suffice', *Financial Times*, 05.03.1991.
- Ellegård, K., Engström, T., Johansson, B., Nilsson, L., Nedbo, L. (1992), *Reflektiv produktion – Industriell verksamhet: förändring*, AB Volvo Media, Göteborg.
- Jürgens, U., Malsch, T., Dohse, K. (1993): *Breaking from Taylorism – Changing Forms of Work in the Automobile Industry*, Cambridge University Press, Cambridge.
- Kern, H. (1979), *Kampf um Arbeitsbedingungen. Motivation zur 'Humanisierung der Arbeit'*, edition suhrkamp, Frankfurt a. M.
- Kern, H., Schumann, M. (1984), *Das Ende der Arbeitsteilung*, Verlag C. H. Beck, München
- Porschlegel, H. (1990). 'Ein neues integriertes Arbeits- und Fabrikkonzept. Das Beispiel des schwedischen Automobilmontagewerks Uddevalla der Firma Volvo', in *REFA-Nachrichten* 1/1990, p. 16–29
- Springer, R. (1992), 'Neue Arbeitsformen in der Automobilindustrie' in *Arbeitsvorbereitung*, Vol. 29, 1992 No. 2, p 57–59
- Volkswagen/Technische Hochschule Darmstadt/Eidgenössische Technische Hochschule Zürich (1980), *Gruppenarbeit in der Motorenmontage – Ein Vergleich von Arbeitsstrukturen*, Schriftenreihe 'Humanisierung des Arbeitslebens', hrsg. vom Bundesminister für Forschung und Technologie, Bd 3, Campus-Verlag, Frankfurt/New York.
- Womack, J. P., Jones, D. T., Ross, D. (1990), *The machine that Changed the World*, New York etc. (German version under the title 'Die Zweite Industrielle Revolution' 1991).

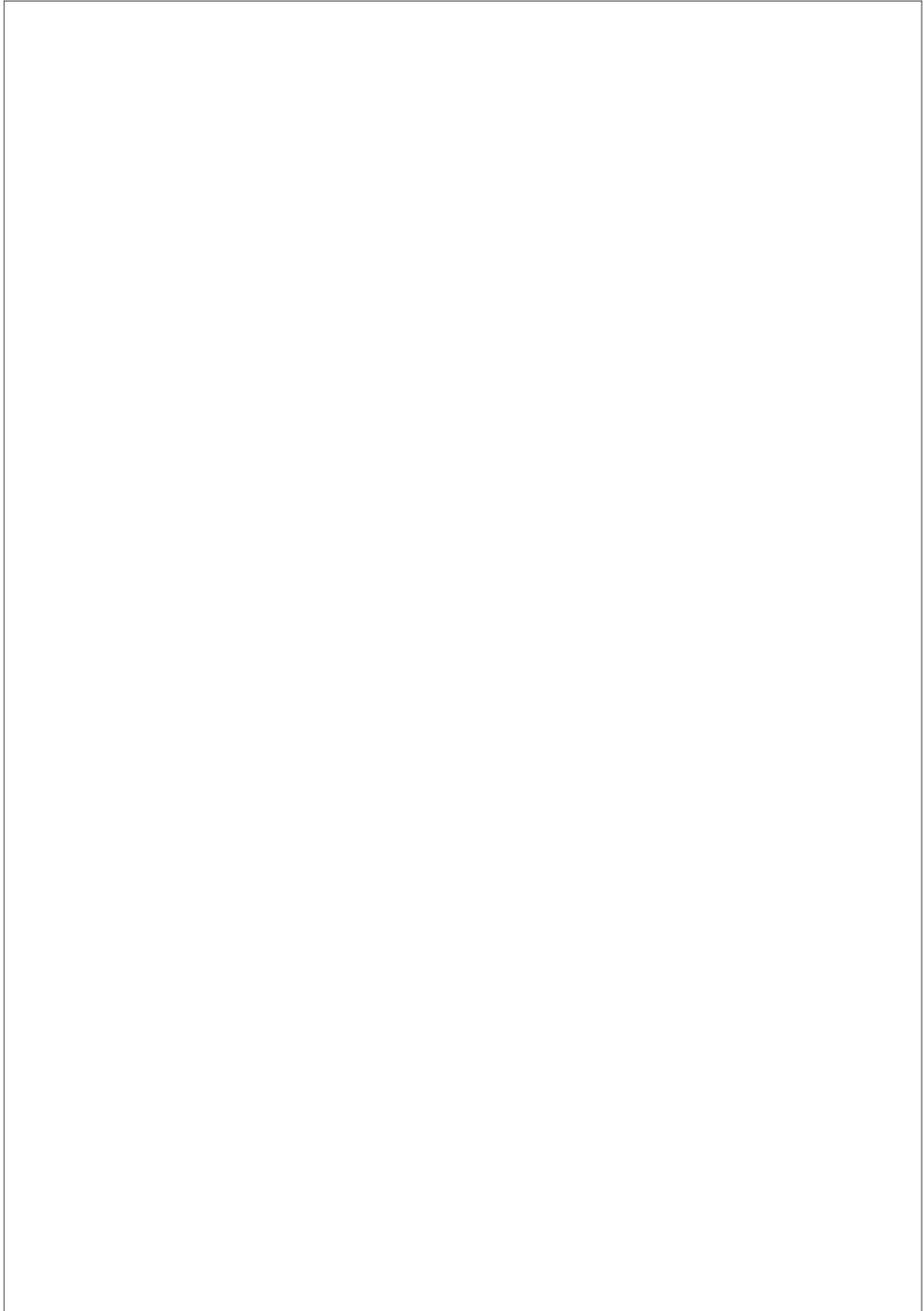

Part III

Volvo Car plants internationally and the alliance with Renault

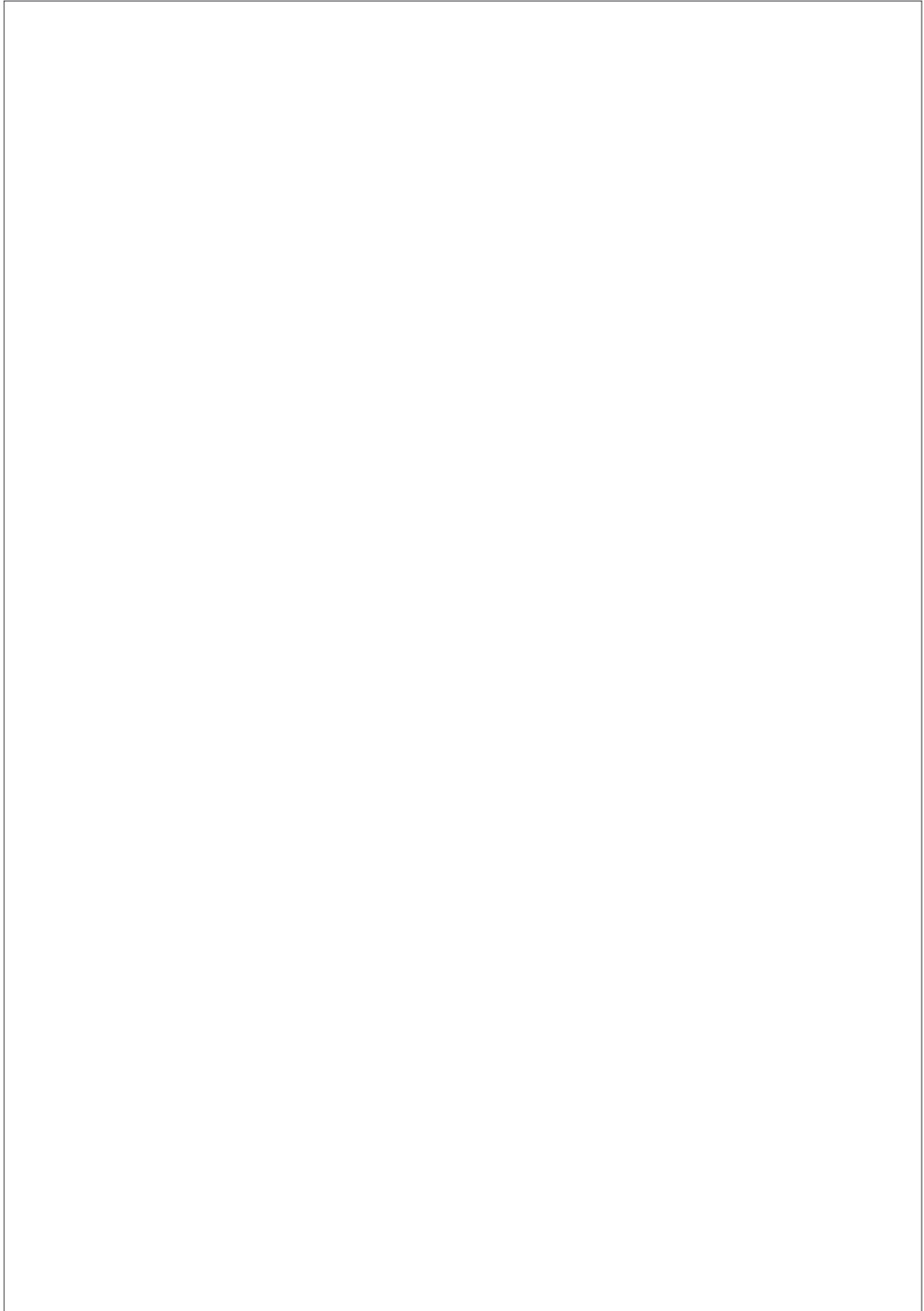

Volvo truck and bus in the UK: The clash of the Titans

Paul Thompson and Terry Wallace

Volvo has had a presence in the UK since 1958, with manufacturing interests in buses, trucks and industrial and marine engines. The company although importing commercial vehicles into the UK from 1967 had began large scale assembly operations of trucks and busses on the Irvine site in Scotland by 1975. Their leverage in the UK commercial vehicle market was enhanced in 1988 by the acquisition of Leyland Bus, with its two assembly plants at Workington and Farrington, plus the latter's component factory. The continuing decline in the UK bus market in the late 1980s meant that assembly of buses was concentrated on the Workington site by 1991, with Farrington now manufacturing components only. In late 1991 it was announced that the Workington site itself was to close with the Volvo B10M bus transferred back to the home base in Borås, while the Volvo B6 and Leyland Olympian was transferred to Irvine. With this latest rationalisation the Volvo commercial vehicle operation now has the two manufacturing sites at Irvine and Farrington plus a sales and marketing operation at Warwick.

The argument

This then is a bare outline of the history of Volvo truck and bus production in the UK. In this chapter we want to focus on the key moments of take-overs, transfers of production and plant closures. These will illustrate the issues of relevance to social scientists, for there are a number of crucial parallels in the UK with debates and events in Sweden. Shutting down Workington and its experiment in dock build and team working took place at about the same time as the announcement of the closure of the Kalmar and Uddevalla plants. Though the uproar that greeted the latter closures in the academic and news media within Scandinavia (Leijon and Ljöfström, 1993) was sadly lacking in the UK, the events and what led up to them do have significance.

In the early days of the acquisition, Volvo set about fundamentally transforming bus production in Workington from traditional flow line production to cell assembly and team working, based around the introduction of docks. In exporting innovative work organization, the company's actions question Berggren's (1990) judgement that there is no 'Volvoism' outside Sweden. But that referred primarily to the Belgian plant, with the UK operation representing a tiny part of the story in his magnificent study of the company.¹ In this respect, our story is part of the wider picture. In closing Workington and relocating to Irvine, a plant which until recently had traditional flow line assembly and work organization, there are uncomfortable echoes of the decision to close Uddevalla and Kalmar.

From a relatively early stage we formed a judgement about company strategy that seems to have stood the test of events. Our argument, in contrast to some commentators (e.g., Auer and Riegler, 1990), was that Volvo has no intrinsic interest in innovative work organization or 'good work'. Observation across the company's range of plants in commercial vehicle production, reveals a heterogeneous stock of work organization practices. In our interviews at ten truck and bus division sites in the UK and Sweden, we heard considerable commitment to 'good work' philosophies and methods such as 'its the natural way of working' (Production Supervisor at Workington). On the other hand it was equally clear that 'the market governs everything in this company' (Finance Manager at Farrington) and 'decisions are based upon economics' (Production Manager at Workington). Volvo is a transnational company which constantly looks at and compares costs across plants, with those that are more efficient and produce better quality products getting the business.

Our view is that these two tendencies coincide in favour of innovative work design with respect to bus production and more recently truck production in the UK, but not necessarily elsewhere. A brief overview of corporate responses to the changing nature of primary markets reveals that within Sweden itself, Kalmar and Uddevalla were attempts by Volvo to sustain and increase its share of specialist niche markets. Within its commercial vehicle division dock assembly techniques, originally experimented in the Gothenburg truck facility, were introduced into the purpose built Borås factory largely as a result of changes in the nature of the bus market. Although there is a high degree of equivalence within its European, South American and Australian bus plants; similar equivalence is missing from the four major truck outlets in Gothenburg, Gent, Dublin North Carolina and Irvine. The bus market itself is now so heterogeneous that single line assembly techniques have become unable to efficiently manufacture the high number of extras or special vehicles that many customers are now demanding.

This is increasingly becoming the case within the truck market, notwithstanding the fact that there is still sufficient demand for standard vehicles in the US and Europe to make the use of flow line methods still applicable. Consequently, the Gent and Dublin factories, which produce respectively, 'FH', 'F and FL' vehicles (Volvo's standard truck models) and White trucks, face management opposition to the introduction of dock assembly techniques. The depth and strength of the current recession in the commercial vehicle market has, however, forced companies such as Volvo to reassess its overall production strategy. They are now more than ever willing to take orders for 'S' or special vehicles. These vehicles tend to be concentrated in the Gothenburg and Irvine factories and consequently it is there that experiments with a mixture of line and dock assembly techniques are currently taking place.

However, we are not arguing for a mechanical 'market rules' perspective. The existence of a repertoire of work organization practices in Volvo and its particular divisions, means that they act as a resource for different individuals and groups to pursue their own ideologies and interests. There is thus a struggle in Volvo, an intra-company version of global 'best practice' in which the key actors within and between management, unions and workforce, struggle to impose their conceptions of efficiency and equity. For example, at Irvine the introduction of dock build into its bus assembly unit, following the closure of Workington, is forcing senior managers within the plant to debate the applicability of the forms of production methods used in bus and, more interestingly in view of the Kalmar and Uddevalla closures, vice versa from truck to bus. This is then the current state of play. Through a series of 'flashbacks' of critical incidents, we will now reconstruct the events and issues in more detail.

The Leyland take-over: Workington vs. Farrington

The Volvo take-over of Leyland Bus was driven by four factors; the need to increase its production capacity; to take out its major UK competitor; to acquire a production facility in its largest market outside of Scandinavia; and finally, to have a bus production facility within the EC in the run-up to 1992. But, within a short time of the take-over, Volvo was faced with a number of harsh decisions based around the need to relieve the under-capacity of 'B10M' production at Borås and the continuing decline of the UK bus market. The first of these demanded that one of the UK plants had to be transformed into a dock assembly facility, so as to facilitate transfer of orders around the company's 'chain' of bus production. The second was that one of the assembly units should close and all production transferred to the remaining plant unit.

As we indicated earlier, at the time of the acquisition Leyland had two major plants at Farrington and at Workington. The view of the executive directors of Leyland Bus was that by closing Workington they would be out of body building and they would be able to retain a headquarter's facility at Farrington. But a major sticking point in this Leyland plan was the proposition for building B10Ms at Farrington on flow line. Consequently, Gothenburg argued for the closure of the assembly facility at Farrington and the transfer of production to Workington. The Swedish argument prevailed for a number of reasons, not least that the President of the bus corporation, Lars Erik Nilsson, who had invested considerable political capital into the Leyland venture, wanted a UK plant which was the mirror image of Borås. This choice was not really surprising. Farrington's old and inappropriately structured building with its BX chassis assembly shop based on pillars and sloping floor was ideally suited to flow line production, which made it impracticable to transfer vehicles laterally across the track. By comparison, Workington had a flat floor and was a large open plan building with a high ceiling. To all intents and purposes it was a structural clone of the Swedish plant.

However it was not only the structural similarities of the two plants which convinced Gothenburg to expand at Workington. The Farrington site has been in existence since 1913, manufacturing a range of commercial vehicles for civil and military applications. An engineering background and strength of craft unionism meant that it managed to retain a highly skilled and well organized blue collar workforce. In contrast, Workington was designed as the first high volume, mass produced assembly line factory with integral buses assembled through car production techniques. One of the underlying philosophies behind the plant was to do away with traditional engineering skills in an attempt to overcome some of the demarcation difficulties the company had experienced at the Farrington plant. In order to move into a greenfield site they felt they needed to recruit semi or unskilled labour as assembly operators.

The whole operation was effectively de-skilled from day one with a flexible workforce all on one rate of pay, with job rotation and a high emphasis on job training, with operators expected to learn other jobs as and when required. (Production Manager, Workington).

The skill profiles of the Workington and Borås workforce and the geographical location of the two plants therefore coincided. Both plants had a largely non-craft, flexible blue collar workforce compared to the largely craft-oriented workforce at Farrington. Both were built in the 1970s and recruited workers from local dying industry, textiles in Borås and steel in Workington, who were less steeped in the history of automotive production and perceived to be more amenable to learning new ways of working:

The Workington plant has undergone so much change in the past and the people therefore are more receptive to change, there are no deeply entrenched working practices that there have perhaps been in the Leyland factory. I think to have introduced team working into the Leyland factory might have been a little more difficult (Finance Manager, Farrington).

Community and geographical factors also intervened. The Farrington factory was very much linked to the history of Leyland as a town and Leyland Motors. Workers at the Farrington plants still saw themselves very much as employees of Leyland Motors, even though the company had gone through a number of name changes over the past 25 or so years. The name of Leyland is also strongly linked to the town of Leyland with all the implications for company identity within the workforce. These links with the traditions of Leyland Motors either did not exist at Workington or were not as strong. Consequently, the process of 'Volvoisation' was less difficult to achieve with the Workington employees. This would have been less of an issue if Volvo had not wanted to introduce dock assembly techniques into its UK operation. It had to have a workforce more willing and able to adopt new techniques of production. A less solid connection to traditional patterns of work and a long standing fear of the eventual closure of the plant meant that Workington was more open to new ideas than perhaps the Farrington workforce. Managers also saw more straightforward similarities:

If you come to a big town or city it is difficult to run a factory there than in the countryside. If you compare Workington to Borås, Borås is a small town, not like Gothenburg which is a big city – 600 to 700,000 people. The relation between the two places is different between the two cities. I think it is the same here. I can feel that as well. When you are in Preston it is a big city in the area, when you come up here, you have more people who are standing up for the industry. I think it is lower upsets here. people know each other more. (Swedish Plant Director, Workington)

But the similarities did not mean that production could be easily transferred. Producing another Borås at Workington was primarily a question of work organization.

Transfer of cell assembly

Though Volvo likes to distinguish itself from its competitors through a perception of having an innovative and pioneering approach to manufacturing, and one that can and should be exported, the transfer was based largely on market contingencies. It is clear that Volvo's reaction to the fragmentation

of the bus market, the increasing emphasis on quality issues and continuing low volume production was to experiment with the dock build and teamwork philosophies.

Line production is OK when you have 10,000 similar vehicles, but not when you have different types every time and you have to build to customer orders. In heavy vehicles where you have low volumes, it is the system. I cannot see how we can build on a line. (Production Manager, Borås)

The original expectation was to completely abandon flow line production at the Workington plant and replace it with the cell assembly system across chassis and final assembly. They wanted to develop autonomous teams of between seven and fourteen workers each with a responsibility for a distinct stage in the assembly function. Responsibility for inspection and quality was to be in the hands of the teams, as was the allocation of tasks within the group. Employment was expected to increase by just under 10 per cent with increased production targets from 80 vehicles in the first year to 1,000 per year after 10 years.

However, when embarking upon a complete redesign of production systems, experience gained from its car and bus plant in Sweden has convinced Volvo that to attempt the installation of a theoretical system without modification to suit local conditions is not feasible. Above all else this involves a recognition of different knowledge systems existing in specific contexts. The knowledge system within, say, a workforce recruited from decaying industries such as mining, steel and agriculture, and operating a traditionally highly disciplined and task specific, semi-skilled environment; is immediately at odds with the a knowledge system able to comprehend the more democratic and self-responsible dock assembly system of Volvo. Such was the meeting of knowledge systems in 1988 at the Workington assembly plant in West Cumbria. To have introduced a complete overhaul of the system at one go would have created more problems that it would have solved. The recognition of different knowledge systems meant that Volvo was prepared to introduce dock assembly on a incremental basis over a number of years.

In January 1990, a small team of operators travelled to Sweden to be trained in the working practices at Borås. The major focus of the training revolved around the introduction of team working within the Workington plant. The initial group of eight were to form the basis of the first assembly team. In June, a further six operators were sent over to Sweden and these two groups worked on chassis assembly at Workington, forming cells covering specific work areas. As others then drifted into the teams, they became fragmented and the dull state of the market limited the scope of training

to only those areas operatives were immediately involved in. So from the initial small team, who covered all assembly operations, the development of later cells saw them performing limited functions, with some operators only being able to carry out one or two of the full range of eight operating tasks. The idea was that those teams in those smaller areas would then build up as production volumes increased. Scale, therefore, in terms of number and size of teams, was very much dependent on volume throughput. The low volumes, 15 buses per week, slowed implementation of full cell assembly across the whole of the plant.

The ideal team for the co-ordinator was said to be somewhere between eight to ten. However of the original eight who went to Sweden, six were made redundant during a rationalization programme on the 'last in, first out' principle. In the early stages, the company was able to carefully select the workers who went on the training programme to Sweden, usually younger workers, and to weed out those they saw as 'contaminated' by traditional British working practices. In the latter stages of the plant's life, the depressed state of the internal labour market meant that the teams had little choice regarding replacements on the next upturn in production. This meant that new recruits had little knowledge of how the system worked and they had to squeeze out one or two operatives, who although technically competent, found it difficult to shed the habits of production line working.

With these and other factors mediating the pace and character of change, it took from 1988 till 1992 for the production regime to change from traditional assembly line to dock build in chassis assembly. But the system in place in Workington was not exactly the same as that in Borås. Nor could it be with an inevitable degree of autonomy and mediation for the actors involved. At Workington, it was very much left to production engineers, managers, and supervisors in conjunction with selected team members from within the existing structure. These key personnel received extensive training on the philosophical, technical and production underpinnings of the system within the Borås plant. However, Workington personnel identified a number of problems which they thought they could rectify, drawing upon their own expertise. Although the philosophy of the two plants was the same, the lay-out and its technical organization was different, as was the ratio of sub-assembly to final assembly work.

Indeed, there is an understanding within Volvo that systems themselves are not static entities, but need to be constantly updated. One way of doing this is to locate production units within several discrete geographical locations and experiment with different inputs. The underlying philosophy in the export of 'best practice' is that one factory should not completely take on the aura of another because each factory has its own history, its own traditions, its own knowledge systems and its own people. This produces

a two-way system which has the effect of constantly pushing production systems to the limits of applicability by improving and developing them. This is, however, a strategy not without its problems. A basic knowledge of Newtonian physics reveals that for every force pushed in one direction there is an equal and opposite counterbalancing force in the other. In the case of Workington, sections of management and trade unions provided that counterbalancing force.

Among managers, there were doubts about the success of the arrangement in the long run. Those closely involved, notably the manager who had initial responsibility for training team members, tended to see the problem in terms of the lack of flexibility and imagination within some of the company's more traditional managers. He was concerned about the way the Swedish system had been 'modified' by UK managers to suit British conditions. To back this up, one operator joked that, 'the best thing would be to lift the whole factory up and drop it into Sweden'.

Management resistance to change, although initially present in the chassis division, was more widespread in the body division and perhaps did not have the wholehearted support of some senior managers at the Farrington headquarters. In one interview, a senior manager in the firm hinted that he was sceptical as to the long term success of the project. He was afraid that the system would end up as a 'half-baked' mixture of British and Swedish methods and was sceptical as to whether it would work successfully in the long run. However, most management resistance was eliminated early on either by bringing in new staff or by processes of conversion. With the appointment of Tommy Svensson as Production Director for the chassis division another Swedish manager commented that initially he:

... did not recognize Volvo here. Tommy brought the Volvo spirit to the chassis. In the chassis division there were some very strange things going on. It seemed that Volvo left Leyland business very much alone for a while, before Tommy came. Tommy started to work with the managers here before he came over. That was a major change. I don't know how good they were before Tommy came, I have no idea. You can see now the difference between chassis and body, there is such a tremendous difference now. (Swedish Production Manager, Workington)

Turning to the unions, there is no doubt that the core of union organization in the plant was in the body division, with both the convenor and deputy convenor coming from within that section. The convenor was less than convinced of the effectiveness of dock build in the factory:

I have always said – we used to do the chassis on a line system and then they put in a dock system – I think we could have built them faster on

a line system. We have been doing them on a dock system and I think we could have done them without having to spend a lot of money on the system (TGWU Convenor).

This anti-dock feeling has its roots not in the system itself, but is largely a result of the separation of the plant into two divisions and the resulting proposed round of redundancies. It was generally accepted throughout the plant that it was overmanned with the body division been the focus for this excess of labour. The splitting of the plant into two divisions gave the company the legitimacy to concentrate its redundancy plans onto the body division, a tactic that was vigorously resisted by the unions. They argued that traditionally the plant organization had been 'wall to wall' which meant that redundancies were organised purely on a seniority principle.

The role of the convenor was also undermined by the split which led to him being excluded from any negotiations concerning the chassis employees. One manager commented on the unions that:

Because they were very sceptical, the comments were passed, 'Oh you have been to Sweden, you have had head lifted off and your wires re-arranged'. They did not believe it, they didn't believe it could work ... I think everything was treated with the inherent suspicion that the trade unions had had for a lot of years. They would not back off, they would not believe what they were told. To be perfectly honest I really do not think that they looked at it in that light at all. I don't think there is anyone here who looked in depth at team working. I think they simply saw it as another method of negotiating. The convenor has been to Sweden and he still doesn't. He stills sees it as a negotiating issue. The problem is, that was has happened now is that chassis areas have developed, we have installed these new working methods, irrespective of the support of the union, we have now a larger and larger group who are prepared to do it and his power has been virtually almost undermined, he is not the force that he was 2½ years ago (supervisor, Workington)

Though some in the plant actually went as far as citing the actions of the convenor and the shop steward's committee as a factor behind the plant closure, this was not the view of senior management. Within the constraints of the existing limited volumes, Workington met its efficiency and quality targets. However, the continuing decline in the bus market and its effect on capacity meant that, irrespective of the plants success in becoming 'Volvoised', it was unable to survive as a stand alone unit. Eyes began to be cast northwards to the truck assembly unit in Scotland and the possibility of merging bus and truck production into one unit. But why choose Irvine, a plant that had more of an independent character, over Workington?

Why Irvine?

The dominant argument in the company is that Irvine management had more of a competitive edge in their outlook and successful performance, plus the plant was considered to have a longer history as being a Volvo operation. Leyland plants, no matter how modern or successful, were still tinged with the ideology of failure. Workington was still effectively only a Complete Knock Down (CKD) operation and did not have the expertise in either outsourcing parts for Volvo products or being able to have full control over the 'bill of materials', or the means by which vehicles were built. In other words Workington was overly dependent on Borås, whilst Irvine was a fully independent unit able to design and organise its own production schedules.

It is also the case that the power base in the company had moved to the truck division. The truck and the bus companies merged in July of 1991, with the Headquarters of the company moving to Warwick and the components part of the business put up for sale. In September, the final nail in the Workington coffin was the resignation of Larserik Nilsson. With this, the last champion of the Leyland operation had gone. The feeling of many managers in both the Leyland and Volvo operations was that he had made a bad judgement in buying it in the first place. In part this had been masked by the strength of Larserik's leadership and the continuing success of Volvo in its other markets. However Volvo's bus sales were now dropping off in all their other markets and this made the Leyland problem more visible given that the operation was no longer cushioned by the performance in the rest of the world. The new MD of Volvo Bus inherited a UK company whose performance was getting worse by the minute despite the organizational restructuring of the previous 12 months. The market was continuing to decline, losses were building up and Volvo Bus was having to concentrate more of its efforts into the UK at a time when volumes at Borås were also in decline. With Sweden having made an application to join the EC, they no longer needed an EC base. What is more, with the Renault alliance coming into the picture some senior voices in Volvo were arguing for the RVI bus division to take over major responsibility for bus production outside of Scandinavia. The role of Leyland in that equation was no longer as relevant. At an executive group meeting in Gothenburg, in November of 1991, the decision to close Workington and shift production to Irvine was made. The announcement was later made on 5 December 1991. The decision was made without the knowledge of any managers at the Workington plant.

The merging of the truck and bus operations

However, as with the move into Workington, the merging of the truck and bus operations and the introduction of some form of dock build will not be

straightforward. To understand this, we have to recognise that the history of the Irvine plant is different from Workington in that it has always had some form of relationship with Volvo. In the late 1960s, Ailsa Trucks began importing Volvo trucks and although the business had quite a slow take off, within three years they were ready to invite Volvo to join them in a more formal partnership relationship. Originally situated at Barrhead, the company moved to its present location in Irvine in 1974, when they had begun the assembling of CKD kits imported from the Gothenburg truck plant. By 1976 Volvo had become 100 per cent owners of the venture. In 1983, they took stock of themselves and accepted that they must become more of a truck builder than a CKD assembler. This led to a total restructuring of the factory, extensive investment and goals of reducing build-time and improve productivity by at least 20 per cent.

This meant that they now considered themselves the functional equals of Volvo's other two main truck plants in Gothenburg and Gent in Belgium.

We felt that the flexibility to have a factory in the market was very essential. We did not obviously want to run an operation that was not competitive with the other Volvo operations in Belgium and Sweden. So we set out to be as good or better than all the others. We set very strict targets and improvements in productivity. In international manufacturing one factory cannot perform worse than all the others, we have always had to be competitive. We strongly believe... that we became competitive within the Volvo family. (Former Managing Director, Volvo Truck)

This notion of family is an interesting one. Generally Volvo is a very orderly company with well defined targets. Not only does the notion of a Volvo family involve national distinctions, it also involves divisional distinctions. In other words, there is no simple idea of what it is to be 'Volvoised', as the process in truck is something different to bus production. For example the goal of duplicating Borås all its facilities within the Workington plant was largely a result of the duplication of product ranges. Within truck, a more complex picture presents itself. Let us turn back for a moment to comments made by the former MD:

I like to think there is a special Volvo culture. Everybody is so proud of what they are doing and it is like a huge big family. I have the opportunity to know many European markets, you have that culture everywhere, but it is more nationalized. In Holland you the Dutch Volvo family, in Belgium, the Belgian Volvo family and so on.

There has, however, been a mixed reaction to the proposed introduction of dock build into Volvo's three major truck assembly plants:

To be honest the truck business is not suited to docks, our Belgian factory is very much against it, the people in Irvine are against it and in Gothenburg it is divided with the majority against it and about a third or a quarter for it (Swedish Production Manager, Workington).²

This is not strictly the case in Irvine, as opinion is now coming round to the idea of dock build. These reactions to team build are not so much expressions of different national cultures, but a reaction to the changing nature of the product range being assembled in the different factories. As the truck Production Manager at Irvine commented:

No, I don't think there is a single best way to build trucks. It depends very much on what you are building, what your volumes are. The Gent factory, they are building, relatively speaking, high volumes of similar vehicles therefore there is a benefit of a normal assembly track. I think we are building low volume, specialist vehicles with different equipment, so something like dock assembly or approaching dock assembly is probably a better way of going. As I said earlier if you are trying to fit a lot of additional equipment and you have to move the vehicle every 40 minutes this becomes complicated. I would like to see, if not a dock assembly for these vehicles, certainly a slower line move time to allow more time to do the work in that area. There is no one answer.

There is a feeling now in the plant that their traditional system of working has outgrown its usefulness and they are consequently in the middle of introducing the team concept throughout the factory. This has caused some problems for them, especially in the definition and role of the charge hand. Traditionally, the charge hand has been seen as part of management. Now renamed as team leader, there is confusion concerning the new role, as manager or as group member. This is largely the result of plant's use of the charge hand in the past in a diagnostic rather than a disciplinary role. This had lead to one production manager asking, 'what is the difference between a charge hand and a team leader'? There is also some tension as to the use of docks in the plant with the Production Manager of the bus division arguing that the system they have introduced is a mixture of docks and lines. There is some evidence that we talking semantics here and what we have is a modified dock, which they have problems labelling as such. Their preferred solution in both bus and truck, is to have two lines, one slow for specials and one fast for standard vehicles, with a dock area for final assembly and frame manufacture. What is clear is that the introduction of the bus has been a catalyst for change in the factory; change that is at the moment experimental. Managers we spoke to question the extent to which Kalmar and Uddevalla plants were successful and do not see their factory falling victim to the same fate. Their ultimate concern is to get the most efficient,

effective and profit-able plant possible. If this can be achieved with docks, that is fine. If not and the use of smaller lines in tandem with docks proves to be more effective, then that is the system that will be used.

Conclusion

If the above discussion had perhaps been about the Ford Motor Company, General Motors or Renault, one could forgive an audience for muttering 'so what'. But, because of Volvo's international association with innovative work organization, what happens in the company carries a wider significance, even in the UK. For example Peter Wickens (1993), the Personnel Director of Nissan UK, has recently pronounced on the 'failure' of the experiments in Sweden indicated by the closures and what they mean for the triumph of lean production. What Volvo has actually done in the UK bus and truck industry is only a small piece in the overall picture. Yet the story appears to be a familiar one. Volvo transforms work organization at Workington in a progressive direction, the plant meets its efficiency and quality targets in a shrinking market, is then closed and production is transferred to a more traditional plant.

The events appear less surprising if the analysis proceeds from the starting point used in this chapter; that for all their justifiable pride in manufacturing expertise, Volvo has no intrinsic interest in particular forms of work design. Rather, the repertoire and choices made reflect the company's strategic response to shifting market conditions. There will be room to struggle over those choices, but the circumstances are not likely to get any easier in the short term. Commenting on the merger between Renault and Volvo, a senior Swedish Government official commented, 'Ten years ago there would have been turmoil from the unions, but not these days' (*Guardian*, 7 September 1993). Although this reflects to some extent the changing nature of European trade unionism, it is also indicative of the gradual recognition by the unions that in Volvo, 'there are no more sacred cows' and that 'remaining competitive' is the only way for Volvo to survive (Per Gyllenhammar, *Guardian*, 9 September 1993).

Notes

1. However since late 1993 the Gent truck plant in Belgium has increased both its product range and of variants within these ranges. Consequently they have begun to utilise dock production technology and team working for the assembly of low volume, highly specialised trucks.
2. Since we spoke to this Production Manager the Gent and Gothenburg factories have switched to a mixture of dock and flow line assembly, largely as a result of the changing requirements of the market.

References

- Auer, P. and Riegler, C. (1990), 'The Swedish Version of Group Work – The Future Model of Work Organization in the Engineering Sector', *Economic and Industrial Democracy*, Vol 11, pp. 291–299.
- Berggren, C. (1993) *The Volvo Experience: Alternatives to Lean Production in the Swedish Auto Industry*, Macmillan, London.
- Leijon, S. and Löfström, M. (1993) 'The Good Work in Sweden – Twilight time? An analysis of the debate following the closure of alternative car production in Sweden', Paper presented at the Labour Process Conference, University of Central Lancashire, March 31–April 2 1993.
- Wickens, P. (1993) 'Lean Production and Beyond: The System, Its Critics and the Future', *Human Resource Management Journal*, Vol.3, No.4, pp.75–89.

Volvo-Gent: a Japanese transplant in Belgium or beyond?

Rik Huys & Geert Van Hootegem

1. Belgium as a car-assembling nation

In international literature, Belgian car assembly usually escapes the attention of researchers. This may be due to the absence of a national car producer or the small size of the country. There are, however, several good reasons why this country deserves a closer look:

There is a long tradition of car manufacturing, starting back at the end of last century with national production plants like Minerva, Imperia and F.N., in addition to some foreign automobile constructors. Soon, however, the growing complexity and technological advancements in car production demanded unaffordable investments from the small-scale Belgian car producers and caused their closure before World War II. After the war, car production was completely taken over by foreign investors.

Car manufacturing is of overwhelming importance for the national economy. Currently, five assembly plants containing welding, painting and final assembly divisions (with Ford having an additional steel-pressing division, wheel and shock absorption production units) are operating in Belgium. More precisely all are located in the Flemish region. With a total production of 1,115,000 cars (Figure 1), Belgium is the largest car assembler per capita in the world (0,11/capita, compared to 0,07 for Japan or 0,05 for Germany and France).¹

There is the good performance of the car manufacturers in Belgium, for which most of the plants are well known. Compared to the production in each plant, the market in Belgium is small². Plants export around 95% of their production, and can as such not rely on the internal market in bad times. Of course good productivity is the main argument for any plant, but there is a continuous awareness in all Belgian assembly plants that it is the only card to play as decisions of major importance are taken in far away headquarters.

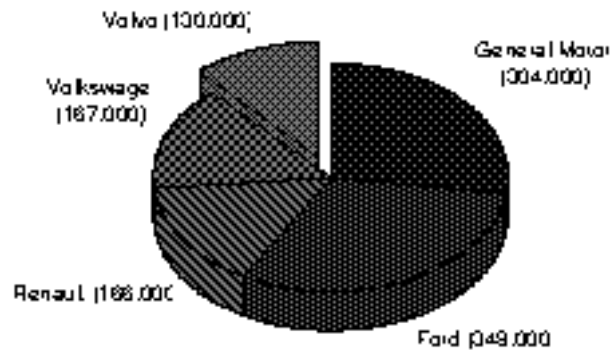

Figure 1. Production of automobile-industry in Belgium (1993)

Signs of this performance can be seen in the remarkable way Belgian car assembly plants passed the slump in the market during 1992–1993 relatively unscathed, without any significant loss of production or lay-offs. Moreover, two plants were able in recent years to attract the exclusive production of a new model (The 850 by Volvo-Gent and the Mondeo by Ford-Gent).³

While any of the five car assembly plants in Belgium has an interesting story, in looking for new forms of organization the biography of Volvo attracts attention. Compared to all other concerns present in Belgium, the Volvo-concern has a strong tradition of alternative work organization. It is also the only producer of luxury cars, which seem to be a more fertile ground for such alternatives. Looking from Sweden and with the wisdom of what has happened in the last couple of years (the assignment of the exclusive production of the 850 to Volvo-Gent, the success this model has proved to be in the market, and the closure of Kalmar and Uddevalla), one might wonder whether the fate of Kalmar and Uddevalla are linked to this plant. At least it looks ironical when at the same time as Volvo-Gent is struggling to meet the huge demand and producing at a current rate of 140,000 units / year in a plant build for 90,000 units, other Volvo plants are closed.

2. How Volvo got involved in Belgium

As was mentioned previously, car production was certainly not new in Belgium as the first Volvo-Amazone drove off the production line in 1965. Indeed, Volvo was the last of several car producers which found their way to Belgium. The decision by Volvo to erect an assembly plant in Belgium was made in the wake of the creation of the European Economic Community (EEC). As Volvo was hardly presented in this important potential market, it was vital for the company to set up its own production units in order to reinforce its position. Especially since custom duties were implemented

around the then six members which taxed imported cars at 22 percent. Although the import of parts was also taxed by 14 percent, a Volvo production unit within the EEC could work under similar conditions as its European competitors.

Gent was chosen as a location in 1963, because the region was experiencing a strong economic growth around the expanding port while at the same time provided an available labour force due to the decline in the traditional textile industry. But above all, the location is at the crossroads of the two main European highways (E40 to G.B. and Germany, E17 to the Netherlands and France), and at the port of Gent with a good maritime connection to Sweden.

Until 1972, the plant consisted of only a final assembly division. Because the number of vehicles grew rapidly, transportation costs, as well as repair costs, due to transportation of painted bodies soared. Therefore, the plant was extended with a welding and paint division. Although ironically, at this moment none of the five assembly plants in Belgium exports as many cars outside the EEC as Volvo-Gent, Belgium still represents an important foothold of Volvo within the EEC. Not only did Volvo-Gent grow to be the biggest automobile plant of Volvo outside Sweden, Volvo's presence in Gent was also expanded by a parts centre for distribution mainly to European countries (1973), a truck plant (1974), and more recently one of Volvo's four marketing centres covering the marketing, sales and after-sales of all Volvo-automobiles in Western Europe (1990). All taken together Volvo actually employs over 5,000 people in Belgium.

3. How Volvo-Gent grew

In such a cyclical market as automobiles, the fate of the Volvo-Gent plant was not without down-turns. After the oil-crisis in 1973, production fell dramatically (figure 2). The newly introduced two-shifts production had to switch rapidly to one-shift again, with important lay-offs and social unrest. More recently production dropped steeply again (1990). This was not only due to the simultaneous phasing out the 740 and 950-five-doors models and phasing in of the 850-model. In an effort to limit stocks of unsold cars in a sloppy market, 24 days without production were introduced and the speed of the production line lowered. As such, no lay-offs were put through since all workers were needed in the newly constructed 850-production lines.

Gradually the Volvo-Gent plant evolved towards a more self-sustaining and autonomous enterprise. Soon after its opening the plant was expanded with a welding & painting division. This gives the location a more economically viable future, an advantage which was denied to Kalmar and Uddevalla. The original markets of the six EEC-countries were expanded to a worldwide

supply. With the introduction of the 850-model the plant has been given for the first time the exclusive production of a Volvo-model. It is also the first time the Gent plant had any involvement in the development of the car. Although even here the design was fully accomplished in Sweden and only the detailed design of parts and their testing could be discussed. Indeed, far from a lean design procedure, the final decision to produce the 850-model in Gent was only made in 1990! If only the choice of where to produce the car had been made earlier in the development, production-engineers of the plant concerned could have helped to control tuning and coordination problems between the development and production of a car.

At the other end of the product line, Volvo-Gent has thrown itself in to the distribution as well, despite some resistance of the central planning division in Sweden. In direct contact with importers, they are allowed to deviate up to three weeks before production from the planning Volvo-Gent receives from Sweden. Of course this requires that the plant be flexible. Therefore, the plant has an important and growing number of suppliers working on a JIT-basis, including some sequential suppliers.

As figure 2 shows, numbers from the past are fast becoming obsolete. Indeed during 1993 and continuing until this moment (March 1994), the plant is in an ongoing struggle to increase production without further investment in order to meet growing demand. Production in three shifts has been introduced in body & paint shops. Two-shift production in final assembly could be maintained by several increases in linespeed. With a mere 90 production-stop per day in body shop and 75 in paint-shop necessary for maintenance work, the plant has an actual production of 624 cars per week. However one final increase in linespeed is planned in April 1994 to reach a limit of 644 cars per week.

Such high capacity utilisation is not unusual in Belgian automobile plants, even when demand is low and plants close down frequently. Indeed, three of the four other assembly plants produce in three shifts, in each case extending over all production units. Plants have little output-flexibility upwards as overtime is legally restricted, heavily taxed and, considering the high un-employment, generally not accepted by unions. However plants enjoy great flexibility downwards as workers put on temporary unemployment are granted additional benefits. Although the cost of flexibility is hereby placed on the social security, this is generally accepted as a measure to divide available work.

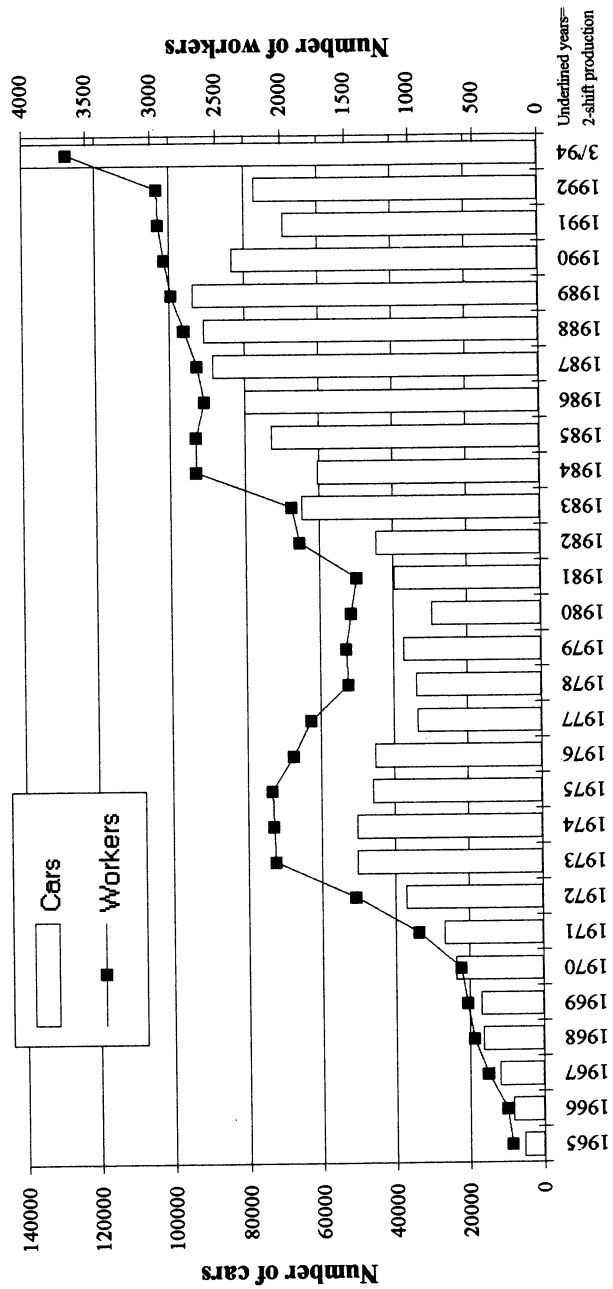

Figure 2. Number of workers and produced cars at Volvo-Gent (1965–1993).

4. Production process and automation: a highly automated plant with some specific features

The body shop

Volvo-Gent consists of three units as most assembly plants do: body shop, paint shop and final assembly. But not only is there no steel-pressing division, a large amount of spot & arcwelding is also carried out in Sweden and shipped to Gent. Although the data in Table 1 & 2 show no exceptionally high automation in the body shop, one must keep in mind that compared to other assembly plants, Volvo-Gent is a 'small' producer. Moreover several high-tech installations are introduced. Among others we mention the laser welding station for attachment of the roof and the automated detection and measurement in the course of the production process. All assembled floors are checked on the presence and position of studs, and at different stages three Perceptron-installations measure the welded body dimensionally by means of laser-beams. As such no 100%-inspection by man is needed until the end of the body shop.

Due to a specific build up of the body in which the front-end and inner & outer side-panels are assembled straight on the floor, these production steps have no large buffers towards the production process as is usual.

Table 1
Degree of automation in body shop

	<i>Total 'average'</i> <i>850-model</i>	<i>Gent</i>	<i>Automation</i> <i>at Volvo-Gent</i>
Spotwelds (number)	4045	2547	92%
Arc-Welding (mm)	8840	7342	56%

Table 2
Number of robots in body shop

	<i>Number of robots</i>
Spotwelding	117
Arc-welding	8
Other (studwelding, hotmelt, Pasta ...)	16
Total	141

The paint shop

Apart from several additional and specific coatings to sensitive areas, connected to the luxury car a Volvo is, Volvo-Gent has a largely classical paint shop. However, one should seek in vain for a separate topcoat repair

spraybooth. Indeed as the production line for the application of topcoat is doubled, the second line has an intake of new as well as repair bodies. In this way faulty topcoats are returned mercilessly.

Noteworthy is the adhesion of a protective plastic at the end of the paint shop on all horizontal parts of the body. This protects the body from damage throughout the further assembly operations as well as during transportation as the plastic remains on the car until delivery to the customer. Since most of the bodies are wrapped in this way, paint-repair after final assembly already shrunk considerably. In the near future all bodies should follow this treatment in the hope to abolish final paint repair completely.

The final assembly

Even in the final assembly, automation is high compared to other Belgian automobile plants. We refer to the automatic sealing and installation of windshield and backlite as well as the automatic engine assembly and rear suspension module lift. Specific is the complete preassembly of the drive train (engine, gearbox, front & rear axles), with fuel tank and fuel & breaktubes on a pallet. Where the lift of the motor and all mechanical operation in the 'chassis' are usually carried out after the trim-operations, the 'wedding' takes place here very soon after the entry in the final assembly area. This build up should increase quality, as almost no operations need to be executed overhead, and as this full preassembly can be tested before entering the body. Indeed thanks to a well thought out production process, automation of inspection, but mainly thanks to the containment of quality problems into the team, the repair-area is breathtakingly small, both in space and in manpower. A result which would undoubtedly raise applause from the IMVP-researches at MIT.

An area of automation which often escapes the attention of researchers is the body-transfert mechanisms. At Volvo-Gent the driven line hides a bewildering variety of transportation means, especially in the final assembly: ordinary body-skids on a chain, but also small AGV's for preassemblies, high carriers, low carriers, palettes on a chain, fixtures on wheels in a track forming a loop... Some of these transfert means facilitate the implementation of alternative work design. But the available diversity present at Volvo-Gent should not disguise the fact that the whole process flow from body shop until the end of final assembly is on a driven line, and with a few exceptions one single line.

The choice to organize production on a single line raises questions. In the past, one easily assumed that a rigid line might be productive but costs inevitably in flexibility. In other words, a single line would be as such incompatible with a flexible production. This brings us to the main question we want to address in this article: how does Volvo-Gent manages to be a

flexible producer and at the same time be productive? Of course this is a dilemma to all car assemblers on a driven line, as are most. But as we want to show, Volvo-Gent is particularly well equipped to combine these two goals. In realising the leap forward from rigid to flexible mass production, both technological and organizational solutions are implemented.

5. A flexible production-process and a flexible workforce

Technical answers to the flexibility problem

In a sense the full potential of the available AGV's on the production floor is not exploited as they operate in a single line. The use of carriers in body & paint shop is merely restricted to the transfer of bodies from one line to another. Only in the final assembly, part of the operations are executed on a carrier with additional ergonomical advantages. However this 'expensive line' remains more flexible as bodies can at several stages be taken out of the process-flow and routed off-line for further inspection and repair. The frequent use of carriers weakens the pressure in a rigid line to 'move the metal' irrespective of the quality. Furthermore it is at the same time a means of transportation and a potential buffer.

More flexibility is attained by postponing the complete identification of the body until its launch in the final assembly. Of course, production in the body shop is in accordance with a planned schedule, but the linkage to any specific order is reestablished after the paint shop. In this way isolated problems in the body & paint shops do not lead to a cancelling of the order, since any other similar body that is available can be used to fulfill the order eventually. As body specifications are less stringent this gives the body & paint shops more space to operate as is usual. Take for instance the colour batching in the paint shop. A fixed link of all bodies with specific orders poses any producer to the following classical dilemma: or not to disturb the process-flow and change colour with each passing body according to its specification (with the obvious disadvantage of spilling solvents and higher environmental pollution), or creating a large buffer to batch the bodies according to their topcoat colour. Where no fixed coupling exists the paint shop can escape this dilemma and considering certain restrictions spray colours in batches as bodies pass by, irrespective of the order.

Of course such advantages are not without a cost. A late body identification requires a large buffer between the paint shop and the final assembly. Volvo-Gent has indeed a very large 'Random Access Bank' with a capacity of 450 bodies, and thus potentially 450 choices. Although this buffer is also needed for bridging the difference in production time between the two units, it enables at the same time an elaborate balancing for operations in the final assembly. In this way idle time in the final assembly can be minimized as

variation in work content are limited. This softens the continuous collision of flexible production on the one hand, and a rigid line, on the other hand. A battle that seems to cause any foreman on the production floor headaches, and is a major source of quality problems.

A further advantage of this large bank, is the additional time it provides for preassemblies and external suppliers to produce parts in sequence. Indeed, more than two hours before the physical launch of a body in the final assembly the scheduling is established. While other Belgian auto-assemblers manage to establish sequential supply for one part (usually seats), Volvo-Gent has five major parts which are delivered in sequence by nearby plants. Again, as option variability seems to rise continuously, this softens another major problem for flexible production on a fixed line: how to provide this rigid production-system with the necessary parts for all variations that it has to swallow?

A flexible allocation of production workers

Of course the greatest potential flexibility remains with the available workforce. Here Volvo-Gent reached considerable flexibility within the Belgian context.

Considering output flexibility, agreement was reached with the unions on the introduction of 'flex-time'. In order to fulfill demand, one hour of overtime is possible on three days per week. This is restricted to the final assembly as the body & paint shops are already working in three shifts and have no further possibility to work overtime. But the flex-time agreement also provides the opportunity to work on Saturdays. Following the mentioned restrictions on overtime, these additional working hours are not paid as overtime but can be compensated on a later date. In practice all overtime during 1993, is currently being compensated for, through the additional recruitment of workers on a temporary basis, which allows production workers to take leaves.

The introduction of the three shift production system is also handled to the plants advantage, by using the nightshift as a flexible buffer. This concerns mainly the body shop in which the subassemblies produce at maximum capacity during two shifts, while at night, a reduced workforce take care of the additional output to reach the required output of the day. The allocation of this workforce depends on the technical losses each subassembly has occurred during the day. Because subassemblies usually produce in overspeed compared to the main line as a safety net for breakdowns, this causes them to lay idle frequently if no disturbances occur. By employing the nightshift workforce in a flexible way, the up-time of subassemblies is maximized and at the same time the necessary manpower reduced, especially since these subassemblies are the most labour-intensive parts of the body shop.

All production workers in the body & paint shops work on an 8-hours nightshift, although production stops during 90 minutes in body shop and 75 minutes in paint shop. In this period production workers take on additional cleaning and maintenance tasks which is often carried out by external services.

This flexible allocation of the workforce is only possible if multitasking is practised. All production workers in Volvo-Gent are members of so-called VEC-teams (Volvo Europe Car), consisting of around 10 workers and headed by a teamleader. Due to frequent increases in linespeed in the final assembly, this number has risen in some areas to 15 and even 20 workers. Generally, in the body & paint shops, all members of the team can be allocated to all jobs with frequent rotation among them. This frequency can be chosen by the team and varies from daily to three or four times per shift. In the final assembly teams are divided in two or three cells, each containing about five jobs in which workers rotate. As such workers can be allocated to all jobs within their cell, usually with complete rotation within a cell during a single shift.

It is important to stress that this rotation is more than doing 'more of the same'. The variety of jobs over which is rotated is wider than usual, a consequence of the plants radical abolition of job classifications. While most Belgian car manufacturers have around four or five job classifications within the executive production workers, Volvo-Gent has only one. This is a unique result in Belgian car assembly, as a reduction in job classifications is a very sensitive area for unions.

To make this concrete by means of an example, let us focus on the automated lines in the body shop. Here part feeders, spotwelders, arc-welders, fitters, polishers, inspectors, on & off-line repair-man ... are all members of teams and have the same job classification. There are no 'fixed' workers to any of these jobs as all members rotate within their team. More strikingly, even robot operators are members of these teams and have the same job classification. While in three of the four other Belgian assembly plants these robot operators are indeed part of the production instead of the maintenance department, Volvo-Gent is the only one to assign them the same job classification. But the plant goes even a step further and expects robot operators to execute production tasks as well. For any robot operator job that has to be fulfilled, at least two production workers are able to do the job, usually with a weekly rotation between production and maintenance tasks. This gives the plant more flexibility to allocate manpower. Any unforeseen absentee, including robot operators, can be replaced. But more importantly, the production worker 'switches' instantly to a robotoperator in the case of a breakdown. While in a segmented workforce production workers stand idle in the case of a production halt, a flexible workforce can be used in machine-downtime as well as in up-time.

The willingness of robot operators to execute production work stems from the plant's policy of 'upgrading'. This means training of production workers as a robot operator, instead of a 'downgrading' policy in which maintenance workers are ripped of their special suit and told they have suddenly become production workers. In this last scenario, management can hardly hope that they would accept 'ordinary' production work as well.

This same story on flexible allocation is realised on many levels and forms a shift from a traditional and counterproductive division of labour. While having 'fixed' inspectors and 'fixed' repair-man weakens the quality-awareness of the production workers, producing good quality causes these specific jobs to be idle. Even worse, they have a personal interest in bad quality in fear of losing their job. Vice-versa having one single job classification for these jobs and having a multitasked workforce needs an investment in training but realises three goals in one stroke:

- quality-awareness is brought to the source of the problem
- allocation of manpower where it is needed (to repair if there is repair to be done, to production otherwise)
- getting the personal interest of the worker and the interest of the plant more in line

Multi-tasking or multi-trading?

The word 'team' means much more at Volvo-Gent than production workers who rotate frequently, however extensive this rotation may be. In 1987, management issued directives for an elaborate new work organization system: a VEC-team plan. Actual implementation on the production floor started in 1989 and was very gradually worked out. This implementation is currently still very much underway.

Figure 3 illustrates the difference in work-organization on the production floor. In the past, one foreman backed by an instructor, supervised some 60 to 70 operators who assembled parts at a driven line. In addition to the production department there were service departments, such as maintenance, quality and material handling which carried out both routine and specialist activities.

Now, all production workers still operate on a driven line, but are integrated in VEC-teams. The former assistant to the foreman has been decentralised to the team and plays a pivotal role as the team leader. He is not chosen by its members, but appointed from above after a long training and selection procedure. While most team leaders are former instructors, team members can be promoted to team leader as well. The team leader has to know all production-tasks within his team as he must be able to train team members and fill in for short periods. In practice he is not involved in production tasks, and he is no stand-by as special substitutes remain available under

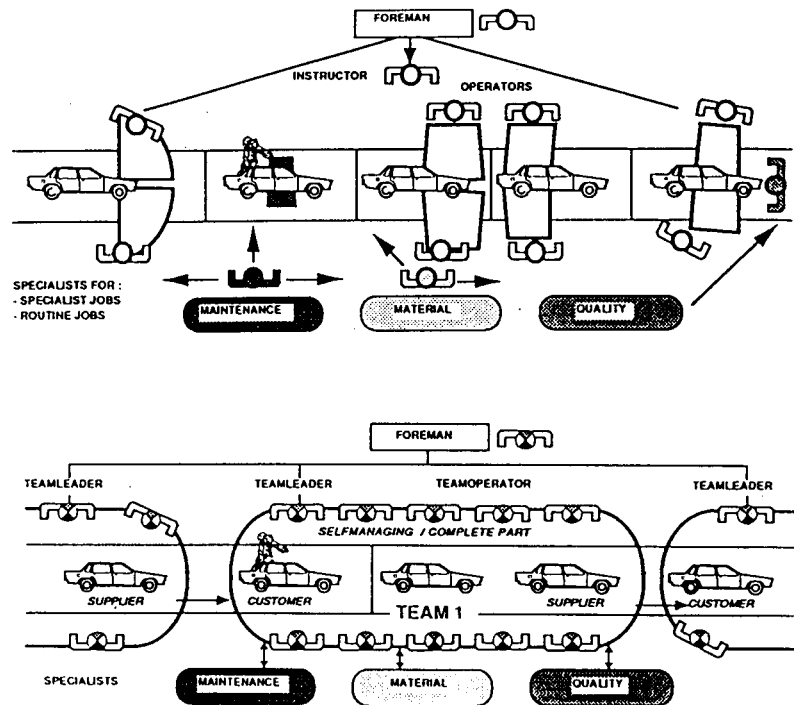

Figure 3. The old and new (VEC-team) work organization (*)⁴

each foreman (who has 2–3 team leaders under his supervision). In order to achieve maximum cooperation the team leader is not given disciplinary powers, these remain the competence of the foreman.

Together with his team the team leader is increasingly responsible for a wider range of tasks:

- checking the quality of its operations
- increasing overall effectiveness of the equipment
- repair of failures within the team
- education and training of its team members
- stand-in in case of absent team members
- set-up and implementation of the team balance
- implementation of prevention policy concerning labour-accidents, ergonomics and environment
- initiate the necessary amount of improvement proposals (in accordance with the plants suggestion scheme)
- preparing and leading the team meetings (30 minutes per fortnight)

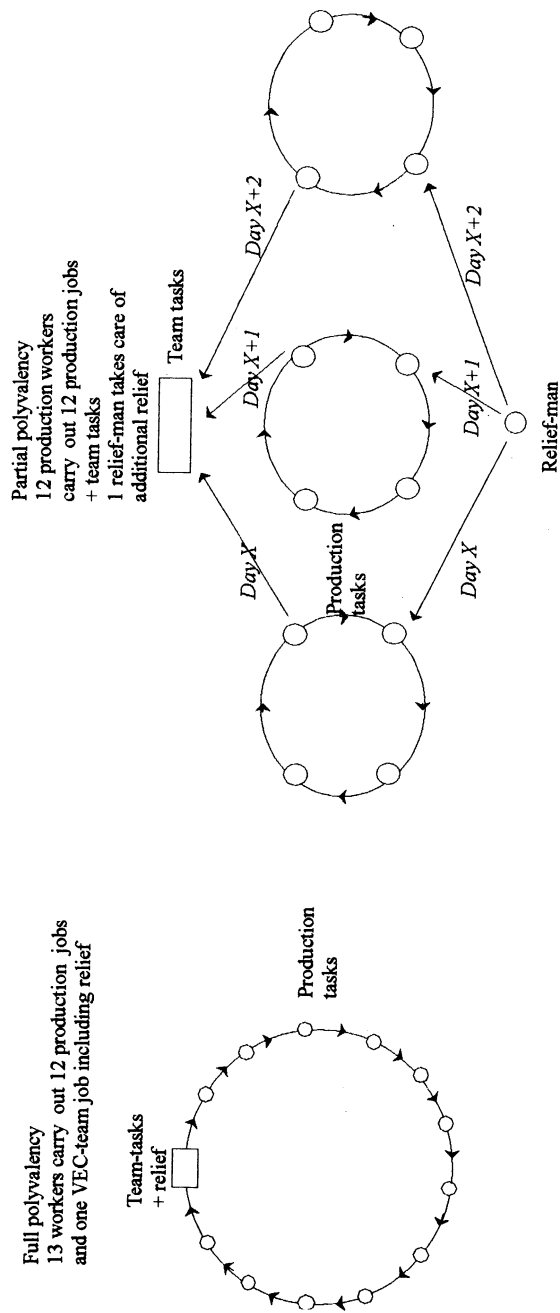

Figure 4. Multi-trading in the body & paint shops, and in final assembly.

While the team leader has a central role to play within the team, it is important to stress that the decentralization of tasks from staff departments do not stop here. As teams are also given additional tasks in quality assurance and maintenance the word 'team' must be understood as all team members, and not merely the team leader. This is a crucial distinction between the Japanese approach to teamwork (as can be seen at NUMMI), and the way in which some American or European producers work out their experiments with teamwork (as can be seen at Saturn).

With production work at a driven line and a cycle-time around 83 seconds in the final assembly and around 100 seconds in the body & paint shops, there are only two alternatives if this decentralization is seriously pursued.

- Either the production line is halted in the course of the shift to enable production workers to take on these additional tasks. This option costs capacity, and is with current demand unaffordable to Volvo-Gent.
- Or production workers are relieved from the line to carry out these additional tasks. This option costs manpower, and is the option worked out at Volvo-Gent.

Every team is provided with an extra team member, the so-called Vec-team man (man is indeed the right word as no women are operating on the production floor). He stands in for individual relief of all operators within the team. E.g., he relieves 12 operators during 30 minutes = 360', plus his own relief = 390'. This leaves 150' in an 8-hours shift during which he carries out the established checklist of maintenance and quality tasks. In body & paint shops this additional man is no 'fixed' person. As everyone is able to do all jobs within the team (with a limitation on the job of robot operator), everyone becomes by daily rotation the Vec-team man. In final assembly where production workers are only allocated to the jobs within their cell, the extra man is indeed a specifically assigned person who relieves another production worker every day during an extra 1.5–2 hours during which he carries out these Vec-team tasks.

Thus the execution of these tasks is restricted to around two hours every two weeks for a single worker. But by extending these rotation systems to all production units, every production worker becomes aware of these quality and maintenance implications while carrying out production tasks.

These additional tasks are gradually implemented in each team in five steps. What these steps mean in general is illustrated by two pillars which are of primary importance for production workers, namely autonomous maintenance and autonomous quality (figure 5). The time each team is allocated to implement each step is only loosely defined. In fact the team evaluates each step on a weekly basis, which consists of answering a number of questions. When a team reaches 80 out of 100 points, a screening committee is invited

to repeat the evaluation. When the committee also gets to 80 points, the team may move on to the second step. Before proceeding to a subsequent step, the team must be able to retain its score on every former step. For each step the team is awarded with a green circle on its VEC-team board. Each step is accompanied by a considerable amount of training for all production workers (dependent on the actual content of the steps for the team, the whole implementation consists of 96 to 151 hours of training for a production operator, 207 to 282 hours for a machine-operator, and 307 to 405 hours of training for a team leader. A supporting factor is the low turn-over (a mere two percent in 1993) by which the investment in training is not lost.

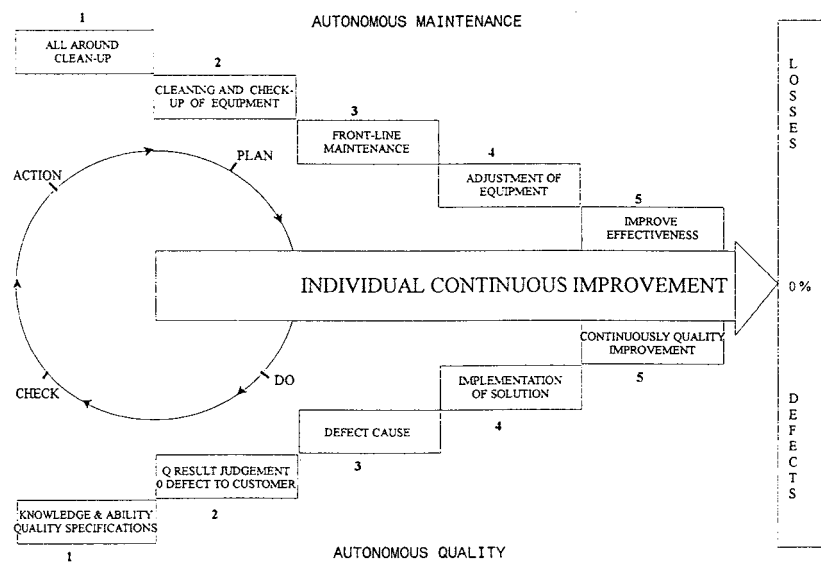

Figure 5. Steps of implementation of autonomous maintenance and autonomous quality.⁵

A thoroughly pursued decentralisation of the staff

At the end of stage 5 the Vec-team plan entails a massive shift of tasks from staff departments to the production floor. In this process the team is increasingly supported directly by staff, who in their turn are brought increasingly under the supervision of the production department. In most Belgian plants the decentralisation of quality-control, maintenance, engineering (and sometimes material handling) under the supervision of the respective unit-managers is common practice. In some cases the decentralisation of part of these specialised functions are brought under the hierarchy of lower production supervisors.

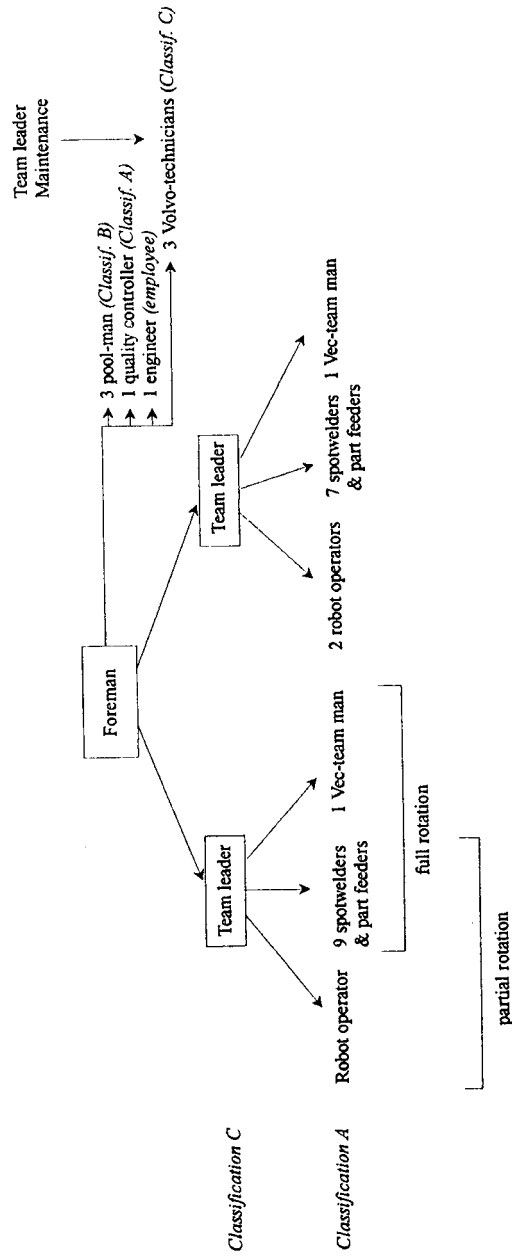

Figure 6. Organizational structure of a foreman area.

At Volvo-Gent, with the notable exception of material handling, this decentralisation goes much further. First of all many maintenance and quality-control tasks are defunctionalised and integrated into the tasks of production workers. All first line maintenance, all 100 percent inspection and all on and off-line repair is fully transferred to the teams. Thus, walking through the plant, no specific functions other than production workers can be seen on the line. Furthermore indirect functions like the pool (workers who stand in for absentees), specialised quality-control, specialised maintenance (albeit functionally) are also brought under the supervision of the foreman. Even an engineer is assigned to every foreman, to work out what the VEC-team goals mean in practice for each team, give support to the teams in working out these goals, and to assist them in optimising work procedures and balancing. This assignment must be interpreted 'physically' as well, since the engineer leaves his office in the staff department, shares the room of the foreman on the production floor and becomes his colleague. At the end of stage 5 and with his help, the teams become quasi-autonomous and self-sustaining small plants within the plant.

For illustration, let us return to our example in the body shop and look at how the very first area of the plant under the supervision of the foreman is organised.

6. Volvo-Gent: a hybrid plant

Much of what has been mentioned resembles what we know, or presume, about Japanese car assemblers:

- production workers operating on a driven line with a standardised work practice
- short work cycles coupled with frequent rotation
- the abolition of job classifications
- involvement of production workers in kaizen through a suggestion plan and team meetings
- enlarged responsibilities of first line supervisors
- decentralisation of the staff and bringing them under the 'pressure' of production

Indeed, it is no coincidence that Volvo-Gent in 1991 was awarded, as the first plant outside Japan, the prestigious TPM-prize from the Japanese Institute for Plant Maintenance. However, the attempt at job enrichment probably goes further than what we know about the Japanese production system, and could be a legacy of Volvo's historical experiments.

Viewed from this perspective, Volvo-Gent may seem a 'traditional' plant with an orthodox line assembly and a traditional work organization.

Yet using these measures, isn't almost any (operating) car assembly plant traditional?

Looking from the Belgian perspective on the other hand, Volvo-Gent can be considered as a pioneering plant for other car assemblers. While concepts as Kalmar & Uddevalla are seen as an answer to a Swedish problem, being high turnover, high absenteeism and recruitment problems due to high education and low unemployment, the goals as described in the VEC-team work organization are widely shared. However, due to a short-time approach resulting in uncoordinated and sometimes conflicting changes in work organization, the failure to pursue an aim throughout all its consequences, and a more conflictuous relationship with unions, they seem unable to actually implement these goals as successfully as Volvo-Gent.

If the perceived 'specific' Swedish reasons (at that time) were correct, there is currently no drive for car assemblers in Belgium to take these experiments as a goal. If we take the example of Volvo-Gent in 1993, turnover was a mere 2 percent, absenteeism due to illness 4 percent, and no recruitment problems despite the recruitment of 227 new production workers on a permanent basis. If currently the pressures from the labour market are weak, the pressure for rationalisation to lean production are all the stronger. As such, both Volvo-Gent and Uddevalla may be proof of Volvo's ability to adapt itself more swiftly and thoroughly to the changing environment.

Information for this article was obtained by a two week field work at Volvo-Gent during February 1994. This consisted of observation and interviews, mainly with second line supervisors (section heads) of all the production steps in the plant.

Notes

1. Data on car production in Belgium are without ckd-activities. Car production in Japan in 1993 was at 8,497,000 / France 2,836,000 / Germany 3,753,000. Source: *Automotive news: Market Data Book 1994*, Detroit. However these data include production of kits sent to other plants. The actual number of finished cars is considerably lower.
2. Registration of new cars in Belgium was at 465,000 in 1992.
3. Production of the 850 is planned to start at Torslanda (Sweden) during spring '94. Concerning the Mondeo, a second plant at Kansas produces the model for the American market since '93.
4. Figure from Saey, E. (1991), 'VEC-TEAM: a Volvo lean manufacturing system', Volvo Cars Europe Industry, p.12.
5. Figure from Saey, E. (1991), 'VEC-TEAM: a Volvo lean manufacturing system', Volvo Cars Europe Industry, p.14.

First DAF, then Volvo and now Mitsubishi

Continuous improvement in a Dutch automobile plant?

Ben Dankbaar

This chapter describes the development of (ideas about) work organization in a Dutch automobile plant, that has changed from Dutch to Swedish ownership and later to co-ownership by a Japanese manufacturer. Two main questions are of interest in this context. First: did ownership by Volvo have an impact on the organization of work in the Dutch plant? More particularly: did Volvo management try to introduce the concepts it had developed in Sweden into its foreign operations? Second: what will be the impact of the ownership of Mitsubishi on the organization of work?

The chapter consists of five sections. The first section describes briefly the history of the plant, its products and its current size. A second section is devoted to the impact of Volvo on organizational thinking at the plant. The impact turns out to be limited. Nevertheless, there were some interesting organizational developments to be noted during the 1980s. These are briefly described in Section 3. These developments were inspired more by Japanese practices than by the Swedes. In a fourth section, we describe some more recent developments in organizational design at the plant, that have more similarity to the 'Swedish model', but are actually more inspired by Dutch socio-technical thinking. These developments have resulted in the introduction of so-called task-groups in production, which are themselves organized in semi-independent production units. A final section raises the question if these recent developments can be sustained under the new co-ownership of Mitsubishi. The latter firm is taking the lead in the design and organization of the new production lines that will be installed in 1994. Some early signals point to an interesting confrontation of ideas.

1. The Born plant: ownership and products

The only passenger car manufacturing plant of the Netherlands is located in Born, in the province of Limburg, the southern most part of the country that

drives a small wedge between Belgium and Germany. The plant was opened in 1968 by Queen Juliana. It was an important investment for a region that was suffering from unemployment because of the gradual closing of the coal mines. A substantial number of former miners was employed at the plant. Since then, labour relations at the plant have been influenced by a mixture of catholic paternalism and authoritarianism on the part of management, on the one side, and a kind of stubborn submissiveness on the part of the workers on the other side. As in most automobile assembly plants, four main activities can be distinguished: the press shop, where metal coils and sheets are being pressed into various shapes; the body shop, where metal parts are being welded together; the paint shop, where the body shells are painted; and the assembly line, where interior and exterior components are added. In addition to these four main work areas, there are some pre-assembly activities, like engine-dressing. Until recently, car seats were also assembled at the plant, but since the summer of 1993, seats have been supplied just-in-time directly to the line from a nearby plant of a French manufacturer.

1968–1972: Dutch government minority owner

The new plant was a major step in the expansion plans of the only Dutch manufacturer of the passenger car, DAF, still a family-owned and -managed enterprise at that time. The production of passenger cars was moved from Eindhoven, where the headquarters were located, to Born, because the firm was running out of space and workers. In Limburg, only 60 kilometers away, an army of unemployed workers were waiting for the jobs. Of course, the government was willing to pay a substantial premium in support of the move. In exchange for its financial support, the government acquired a 25 percent share in DAF.

DAF was founded by Hub van Doorne in 1928, as ‘Hub van Doorne’s Machinefabriek’.¹ Initially it produced assembly tables and storage racks for Philips (also located in Eindhoven), but then switched to trailers. The name was changed into ‘Van Doorne’s Aanhangwagen Fabriek’ (DAF). Van Doorne was a productive inventor. In the mid-1930s he developed a system to turn 4-wheeled trucks into 6-wheeled all-terrain vehicles and received important orders from the Dutch Ministry of Defense. By 1940, DAF produced almost exclusively trucks and armoured cars for the Ministry of Defense.

In 1948, the company was renamed ‘Van Doorne’s Automobielfabriek’ and received a 6 million guilder credit from the Dutch Bank for Recovery to start up production of commercial trucks. It was also helped by a temporary embargo on imports of trucks between 3 and 7 tons, imposed by the Dutch government. In 1951, DAF received a 175 million guilder defense order within the framework of Marshall Aid.

In the 1950s trucks and trailers remained the most important product

for DAF, but by 1958 it presented its first passenger car to the world. It incorporated a new invention by Hub van Doorne, the continuously variable transmission 'Variomatic'. DAF's work force increased from 590 to 4,500 between 1950 and 1960. In 1964, the 100,000th passenger car was manufactured. Production in the new plant took off quickly and doubled within five years to reach almost 100,000 in 1973.

1972–1975: Volvo minority owner

Meanwhile, DAF was split up in two separate entities: DAF Trucks BV and DAF Car BV, both owned 100 percent by DAF. The purpose of the separation was a change in the ownership situation. DAF needed additional funds to finance new expansion plans. Its size, although growing, was far too small compared to its competitors and it needed a partner. The Swedish car manufacturer Volvo came to the rescue. Volvo acquired a 33 percent share in DAF Car BV in 1972. It seemed a good idea at the time. Production at the DAF plant was expanding steadily, it had experience with relatively small cars that would nicely supplement the Volvo product line of larger and more expensive cars, and it was ideally located to serve as an entrance point to the Common Market.

1975–1981: Volvo majority owner

During the next year, the 1973 oil crisis hit the automobile industry with full force and DAF Car suffered badly. Production dropped to 70,000 in 1974 and 61,600 in 1975. Market shares of the Dutch passenger car market dropped from almost 8 percent in 1968 to 4.5 percent in 1975. Volvo had to supply additional finance and in the process increased its ownership share to 75 percent (1975). DAF Car BV was renamed Volvo Car BV. Soon after, all ties with DAF were severed. The remaining 25 percent share of Volvo Car BV was transferred to another state owned enterprise (DSM, the chemical enterprise that continued chemical operations that had started on the basis of coal mining).

1981–1991: Dutch government majority owner

However, the 1970s did not offer a friendly climate for a small car plant. In 1977, Dutch market shares fell below 2 percent and even lower in other European countries. The plant needed further financing in order to develop new products. Both the Dutch government and Volvo provided additional support. As a result Volvo's ownership share decreased again to 55 percent in 1978. In spite of rising production and sales after 1977, the cash flow remained insufficient to cover development of new products. The second oil crisis of 1979/80 put an end to the upward trends. The additional aid given by the Dutch government in 1981, resulted in a change in ownership

once again. Volvo lost its majority ownership to the Dutch state and retained only 30 percent of the shares. The plant continued to manufacture cars under the Volvo brand name and relied on Volvo for some of its engineering and marketing functions.

Since 1991: equally shared ownership of Dutch government, Volvo and Mitsubishi

The 1980s and especially the second half of the decade were an era of growth, as new products were introduced and production came close to 150,000 units. Nevertheless, the financial basis for the enterprise remained too narrow and the Dutch government was neither willing nor able (nor permitted on the basis of EC competition policies) to provide unlimited additional support. Together with Volvo, a new partner was searched for, and found: the Japanese manufacturer Mitsubishi. In the fall of 1991, an agreement was reached between the Dutch government and the two car manufacturers to share ownership of the car plant on an equal basis. It is also understood that the Dutch state will sell its remaining one third of the company to the other two owners before the end of the decade. Starting in 1995, Mitsubishi will make use of the plant to produce a new car for the European market, while Volvo will continue to use the plant to manufacture the current product as well as the follow-up model, that will be based on the same platform as the Mitsubishi. Total capacity will be expanded to 200,000 units, 100,000 for each of the two partners. Until 1995, losses on current production (of the Volvo 400 series), will be carried by the Dutch State and Volvo Car Corporation on a 70:30 basis. Obviously, the name Volvo Car BV had to be changed. The enterprise is now called 'Netherlands Car BV', abbreviated to NedCar. The three owners have committed themselves to invest 2.1 billion guilders (700 million each) in the plant (i.e., for the development of the new model, including the production installations). This commitment also implied that the 600 jobs at the Engineering and Design department were also guaranteed until 1995.

Products

The original products of the plant were DAF's original models: the DAF 33, 44, and 55, all equipped with the Variomatic. When Volvo took over in 1972, the DAF 66 and a completely new model were already under development. After six years of development, in 1976, the new model was launched as the Volvo 340. With this product, the plant moved from the lowest market segment to the lower part of the medium segment. At first, the 340 didn't sell very well, but after a change in pricing strategy and the introduction of various product variants, the 300-series began to sell quite well in the late 1970s. Work on a follow-up model started almost immediately. The aim

was to move further upwards in the market. This aim could be followed with greater energy after Volvo had lost its majority influence in 1981. The first model of the new 400-series became the Volvo 480, a small sports car, that clearly represented a major jump towards a higher market segment. It was launched in 1986, to be followed by a hatchback (440) and a sedan (460) in 1988 and 1989. Production of the 300 series, which continued to sell quite well throughout the 1980s, was discontinued in 1990. Currently, the plant's engineering departments are working on the follow-up model in close cooperation with Mitsubishi. The new Volvo model and the new Mitsubishi model will be based on the same platform.

2. The impact of the Swedish model

Between 1975 and 1981, Volvo AB of Sweden was the majority owner of the plant in Born. In 1974, Volvo had opened its new plant in Kalmar, a widely acclaimed experiment in work organization and factory design, introducing stationary assembly places instead of the continuously moving assembly line. The Kalmar plant represented an important step in the development of what came to be called the 'Swedish model'. The movement away from short-cycled assembly work is characteristic for this approach and has since inspired similar developments in other car plants, especially in Germany. However, none of the ideas and experiments that were current at Volvo in Sweden, were transferred to the Netherlands. In the history of the plant, this period is viewed by most insiders as a period of neglect by the owners. Products that were in the pipeline when Volvo took over, were introduced according to plan, but there seemed to be insufficient interest and no clear strategy as to the future of the plant and its products.

The lack of interest in transferring Swedish concepts of work organization to the Dutch plant may have various reasons. It may have been the result, as suggested, of the failure to take a strategic view of the investment in this plant and its products. This may have been compounded by the problems caused by the second oil crisis, when money to implement changes anywhere became quite scarce (in Sweden tax exemptions and other government subsidies may have played an important role). It also seems to indicate, however, that Volvo management considered its experiments in Kalmar as appropriate in the Swedish context, but not necessarily in other countries. This underlines that a dominant motive for the introduction of new production concepts in Sweden was the situation on the labour market. Very low rates of unemployment and a well developed system of social security and job protection had led to high rates of absenteeism and personnel turnover. Improvements in the quality of work were viewed as a means to fight these phenomena and increase worker motivation. Lengthening the work cycle

was seen as the primary means of improving the quality of work. Apparently, there was little or no expectation that the new concepts would contribute to productivity in a situation where absenteeism and personnel turnover were less of a problem.

From 1986, Dutch management carried out some experiments with longer work cycles in the production of the Volvo 480. The 480 was produced on a separate assembly line in relatively low numbers. Some automated guided vehicles were introduced, which enabled workers to ride along with the bodies and carry out a series of assembly tasks, resulting in a lengthening of work cycles. Although the results in terms of labour productivity, as well as the quality of work were positive, the approach was not extended to the assembly processes for the rest of the 400 series. The costs of the automated guided vehicles were considered too high. There were also some tryouts in which complete bodies were assembled by a small team. Again, however, the necessary changes in layout and equipment were considered too expensive to be justified. Apart from these experiments, work cycles at the plant have been and continue to be between 30 and 60 seconds.

3. The New Style: Deming in the Netherlands

Things changed when Dutch management was released from the ties with Volvo in 1981. A new plant manager was appointed, Mr. André Deleyme, who is a Belgian citizen. In the spring of 1982, he took the initiative for a major project to change the organization, quality and management style, which was called the 'New Style' project. The project had various purposes at the same time. Its first aim was to make a new start in the plant, that had undergone extensive rationalization measures in the previous year. In that sense, it was a conscious effort to create a new climate and a new culture in the enterprise. The second aim was to improve performance on all levels.

The 'New Style' project was inspired by press stories of the contributions of the American professor Deming to the successes of Japanese enterprises. Deleyme visited the Nashua plant in Boston and came back with the conviction that major improvements in quality were possible. Deming had already shown in the 1950s that 85 percent of the manufacturing mistakes were a result of faulty management. These mistakes were a result of mistakes in the systems and the organization that were the responsibility of management. They could be prevented by transferring more responsibility to operational levels, where the use of simple measuring techniques like statistical process control (SPC) would often be sufficient for dramatic improvements in quality. The application of such techniques by production personnel would in effect shorten feedback loops and eliminate the need for special inspectors. With this message of a less strict division of labour between work execution

and inspection, Deming had not been very successful in the United States, but very influential in Japan.

The main idea behind the 'New Style' project was to make better use of the capacities of the work force in order to increase flexibility, improve quality and lower costs. It took the form of a large number of improvement programmes ('Management-Directed Programmes') in all departments and involved training in various analytical tools, statistical techniques and quality thinking for all layers of personnel, starting with management. There was strong pressure on the various actors to succeed quickly. This may explain why the various improvement programmes emphasized short-term, technically-defined goals. Although the 'New Style' was launched with considerable emphasis on the need for a different style of management (based on the need to involve workers), the reality was that management changed very little, but the workers had the impression that they had to do more and work harder.

On top of that, latent tensions between the production people, on the one hand, and the 'office guys' on the other hand, came into the open. It should be mentioned here that all (advanced) product development and process engineering functions, the board of directors, and their staff are not located in Born, but 40 kilometers to the North in a glossy glass building, which has not helped to overcome the inherent barriers between these various functions.² Internal criticism and evaluation led to a revision of the project in 1984, which was launched under the title MENS (More Elan New Style; mens = human in Dutch). The revised approach would give more attention to social aspects, i.e., to the quality of work and aspects of motivation. More attention was given to organizational matters, such as the need to shift responsibility to the people who were going to do the actual job. Projects also became less technical (also, because less money was available for investment in new gadgets).

The new approach implied more work for the heads of the various production departments (press shop, body shop, paint shop and assembly). At the same time, the plant was preparing for the launch of new products. Obviously, the department heads would need support. More than that, they needed people who would function as their 'New Style' conscience and who would remind them constantly of the need to involve the work force and make use of this important resource. Consequently, for each department, the function of 'mentor' was created. Older experienced foremen were chosen to play this role. They were charged with drawing up annual action plans and had to oversee that all foremen would be trained in various techniques of process control.

The mentor idea turned out to be quite useful and still being utilized. The 'New Style' project, however, slowly came to an end. Originally planned to

last until the end of 1985, there has never been an official announcement of its ending. The phrase 'New Style' was used less and less frequently. The idea was of course that after almost four years, the 'New Style' would have become the normal 'Volvo Style'. In reality, it had taken four years before the 'New Style' became visible in new organizational arrangements like the new mentor function. In the meantime, workers had been confronted with a bewildering array of projects, training activities and also outside consultants, with very little change in the quality of work. Scepticism of the workers (and in fact of most of the production management), had grown immensely.

4. Work restructuring

In 1987, the plant management team took the initiative and presented the board of directors with a report on production policy. The report argued that a lot of attention had been given in the recent past to products, production processes and human resources, but not to the structures of work that tie these things together. A new production policy would have to be developed that would define targets for which the individual departments could be held accountable. The plant management initiative coincided with comparable actions by the board of directors. The board was introducing a flatter organizational structure for the whole organization, aiming to move responsibility and accountability to lower levels. By eliminating the separate directorate for car operations (that had been organized as a separate division), members of the board themselves became responsible for operations. The Car Division was split up in three sectors, each of which was led directly by a member of the board: business planning and control (BPC, including advanced engineering), technical operations (TO) and commercial operations (CO) (see figure 1). All production activities taking place in the plant in Born belonged to technical operations. Apart from production, technical operations also covered three other activities: product engineering, process engineering and supply (purchasing). Most of the personnel involved in these three activities were located in Helmond.

After extensive debate, the plant management initiative resulted in the introduction of so-called production units in the plant over the course of 1989. This involved a considerable change in the composition of the management team for the plant. Before the introduction of the unit organization, the management team consisted of the plant manager, the production manager and the managers of functional departments like quality assurance, manufacturing engineering, materials management and personnel. The heads of the individual production departments (press shop, body shop, paintshop and assembly lines), all reported to the production manager. In the new setup the

Redesigning the top structure, 1988
before...

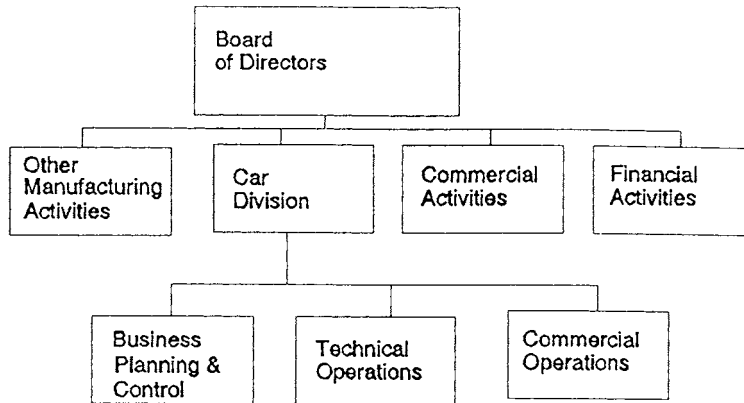

after...

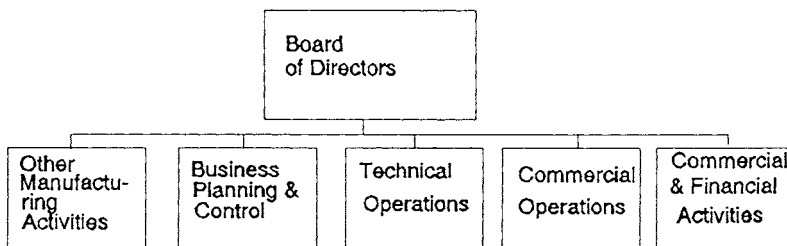
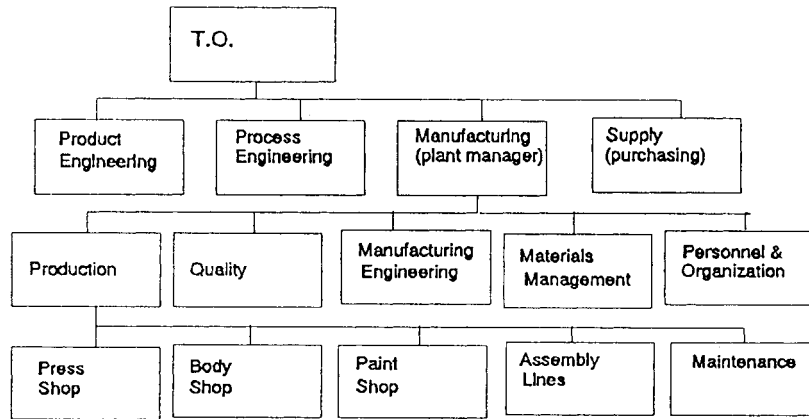

Figure 1

management team consisted of the managers of four production units (the four main production areas just mentioned) and the manager of a unit called 'location affairs', responsible for various matters related to the plant as a whole. As far as possible, all of the functional departments were divided up over the four production units, which became self-sufficient in that respect. Every production unit received its own personnel, engineering, quality and finance/controlling functions. Maintenance had already been reporting to the production manager and was now further decentralized to the units. Some plant-level personnel and organization functions were maintained as a kind of staff functions to the plant manager (see figure 2).

Redesigning the plant organization, 1989
before...



after...

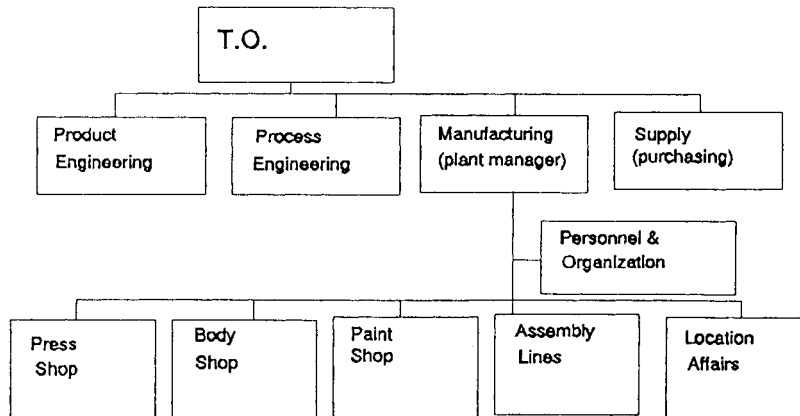

Figure 2

Obviously, functional departments and their managers were losing some status (or were disappearing completely), in this setup, since they were moving 'under' production instead of having equal status. A large part of the debate on the new organization had been concerned with the question of all supportive tasks being moved to the production units or if some tasks should move to the other three parts of technical operations, i.e. to product

development, process development or supply. In the end, parts of materials management and manufacturing engineering went to supply and process development respectively.³

The managers of the production units, on the other hand, obviously had to be more than simply production managers. Whereas, the former heads of the production departments were responsible only for production, the new unit managers were responsible for the support functions as well. Depending on the unit, between 30 and 40 persons were employed on maintenance, engineering and quality alone. Additionally, there were the persons involved in personnel, organization, management information and control. Each unit was composed of three production groups, covering clearly identifiable components or processes (in fact, after considerable reductions of the work force over the past few years the units consisted of only two production groups at the end of 1993, except for the assembly unit, which still had three). The heads of these production groups were each overseeing seven to eight area leaders. Each area leader was in turn responsible for two or three task groups of approximately 15 workers each. The size of a production unit could thus, vary quite substantially; at the end of 1993, the press shop unit employed approximately 300 people, while the unit assembly employed approximately 1,200 people (see figure 3).

The unit managers had a much larger range of responsibilities than ordinary production managers and had to shift responsibility for production further down the line. Obviously, the old heads of the production departments were not always the most likely candidates for the job of unit manager. In fact, until recently, the unit managers had a head of manufacturing reporting to them, who was to oversee the production groups. The old 'New Style' mentor function was maintained for each unit as a support function to the unit manager. From the very beginning, a further decentralization of responsibilities was envisaged. In fact, the proposal for the unit structure had already included a proposal for further decentralization of responsibilities towards the task groups on the shop floor. The new unit managers were charged with the introduction of creating such task groups.

The expression 'task groups' shows the influence of Dutch socio-technical thinking among the managers and staff participating in this reorganization process. The socio-technical tradition in the Netherlands is strongly based on systems analysis. It has developed and advocated a specific set of rules for redesign of organizations.⁴ These include shifting control and regulation tasks to the lowest possible level in the organization, where the lowest level is usually not an individual but a 'complete task' (i.e., a technically and in time and space identifiable part of the production process), that is carried out by a group of workers. The general sense of the approach is captured aptly in the phrase: 'simple organizations, complex jobs.' The Dutch

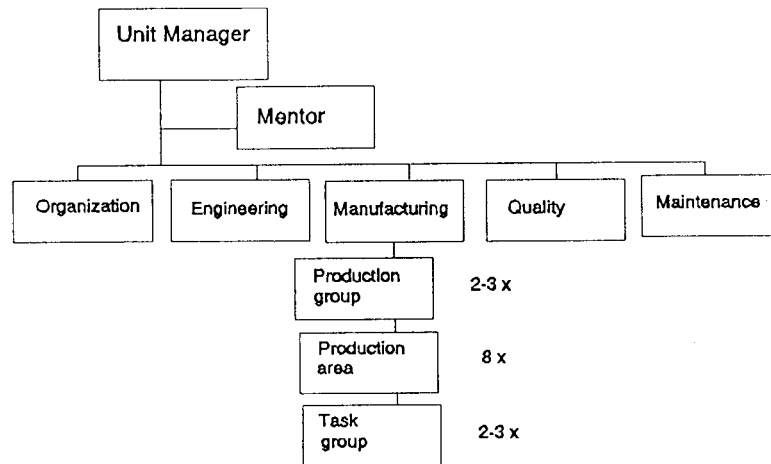

Figure 3

socio-technical approach is critical of efforts to deal with an increasingly complex environment by means of ever increasing functional specialization. Instead, it argues that the ability of organizations to deal with complexity should be located in the flexibility of semi-autonomous work groups. One should note that improvements in the quality of work can be the result of redesigning the organization according to this approach, but it is not the prime purpose of the approach. The purpose is to create organizations which can function adequately and flexibly in a complex environment. Normally, the creation of semi-autonomous working groups in a production environment will lead to job rotation (multiskilling), and job enrichment (taking on self-regulatory tasks), but the Dutch socio-technical approach does not start from the premise that individual work cycles have to be lengthened. At the Born plant in 1989, socio-technical concepts like task groups were introduced by management mainly for two reasons: to enhance feelings of loyalty to work and to create a structure with more perspectives for change and continuous improvement.

Until the middle of 1990, the new unit managers were busy coming to grips with their new responsibilities. First pilots for the design of task groups were then started in the press shop and the paint shop (some experiments had already preceded these pilots in the press shop). Identification of 'complete tasks' for the task groups was done by line management (head of the production group and the area leader) supported by the plant staff group for organizational development. Taking layout and equipment as given for the time being, complete tasks included not just an identifiable set of production tasks but also quality assurance, materials management⁵ and what are called

‘regulatory’ tasks. Once these tasks had been identified, manning levels and (on-the-job) training requirements had to be established. Between 1990 and 1993, task groups were gradually introduced in all the production units. By the end of 1993, this process was nearly completed.⁶ A total of 140 groups had become operational.

In most task groups, coordination tasks are still the responsibility of the area leader. The aim is, however, to have coordinators who are working members of the group. Training programs have been set up for this purpose. By the end of 1993, some 40 working coordinators were available (but about 300 are needed, if you want to have one in each shift). The ideal would be to have the task of coordinator rotate between all group members, but this obviously depends on the ability and willingness of the group members. The coordinator is the speaker for the group and contact for communication with other task groups. Each task group has a set of tasks consisting of approximately 10 production tasks and 12 indirect and regulatory tasks (e.g., quality control, materials supply, maintenance of tools, detailing production schedules and work assignments, maintaining standard operating procedure forms, production statistics, planning of holidays, advisory role in the hiring of new personnel).⁷ Again, the ideal would be for all workers to have the ability to carry out all tasks (multiskilling), and rotate along different jobs. In practice, some workers may not be able to achieve that ideal. The result of multiskilling will be that workers will move to higher salary grades. In 1990, each worker was tied to one production task. Now, workers on average can handle five different tasks and the aim is to reach an average of seven in 1995. Similarly, production workers did no indirect tasks in 1990, in 1993 they did two on average and by 1995 the aim is to reach an average of six.⁸

The introduction of task groups received a mixed reception by the work force. On the one hand, there was a general distrust of new concepts based on past experiences. On the other hand, people were afraid that they would simply have to work harder and carry more responsibility without an appropriate raise in pay levels. A survey carried out in the summer of 1993 (as a joint project of the Works Council and Plant Management), showed that a majority of the workers in task groups (68 percent) agrees that it wasn’t as bad as they expected, but even more (79 percent) underlined that the task groups were not yet functioning as they should. Although 83 percent of the workers said they were willing to make the task groups a success, the majority (52 percent) would prefer to go back to the old situation. The plant management has made it very clear, however, that they don’t want to return to the old work organization. They clearly see the task group organization as a way to achieve the considerable increases in productivity that have been agreed upon with the new owners of the plant and that need to be realized

by the end of 1994. In reaction to questions of the work force, data were published which showed that the share of workers in higher wage groups had increased markedly between the summers of 1992 and 1993. Basically, a kind of pay-for-knowledge system has been installed, although there is limited access to the highest grade, depending on the availability of positions. Workers who are unable to master enough tasks to enter a higher pay grade may in the future be rewarded for seniority.

More recently, and partly due to pressure from Japanese management (see below), the task groups have also been encouraged to engage in continuous improvement activities. As noted above, this was originally one of the aims of management in introducing task groups. A formal structure is being elaborated for the creation of project-oriented improvement groups in which task group members cooperate with production unit quality and engineering staff.

5. Mitsubishi takes over

For the future of the plant, Mitsubishi is obviously of crucial importance. The volume of production that Volvo could offer in the past was simply too low to guarantee survival. The cooperation between Renault and Volvo seemed to make the Dutch Volvo plant even less necessary, since it could be assumed that Renault would also have sufficient capacity to produce 100,000 medium-sized Volvos. Now that the merger between Renault and Volvo has been called off, this specter of a complete loss of Volvo business seems less likely. On the other hand, the danger is still present that Volvo will not be able to survive as an independent passenger car manufacturer in the longer run. Volvo may have to find other partners, who may again question the need for a small plant in the Netherlands, unless of course the new partner is Mitsubishi.

The cooperation with Mitsubishi came about because Volvo could not afford the plant and related product development costs and therefore needed to share the costs with another manufacturer. Dutch and Swedish product development staff are currently engaged in the final stages of development of the follow-up of the Volvo 400 series, which is based on the same platform as the Mitsubishi model that will be produced in the plant starting in January of 1995. The success of this new car will be crucial to a continuing Swedish engagement in the plant. If the new car is not successful, Volvo will probably be forced to retreat to larger luxury models. In that case, Volvo would drop out of Nedcar at some point in the future. It is not unlikely that Mitsubishi has been anticipating this all along. It has followed a similar course in the United States, where it started a joint venture with Chrysler

and later took over Chrysler's share. The Diamond-Star plant in the United States currently serves as a model for the Dutch plant.

Whatever will happen, it is clear that Mitsubishi has taken on a very active management role in the plant, more active than Volvo has ever been. Norio Takehara represents Mitsubishi on the board of directors and is responsible for process engineering. As such, he is not directly involved with current manufacturing practices, but the new production lines that will start in 1995, will reflect his views. Obviously, the changeover to the new line will be easier if these views are already implemented in current practice wherever this is possible. It is therefore understandable that Takehara set up his office in the Born plant and then moved the whole process engineering department from Helmond to Born. It is probably also the influence of the Japanese that forced the decision to move the board of directors and all corporate staff functions to the site of the plant. Only product engineering and design has stayed behind in the Helmond offices, facing a rather uncertain future. It is not clear that Nedcar staff will be involved in developing and designing a new series of cars following the generation that is currently being developed. Or at least not with the same intensity, that had been part of the deal made between Volvo, Mitsubishi and the Dutch government. The possibilities for them to carry out design and development for third parties are currently being investigated.

It is common knowledge that the Japanese car manufacturing system is highly efficient. Japanese management is naturally convinced of the effectiveness of its own methods. Dutch management is faced with Japanese managers who do not directly force them to change their ways, but who are quietly pushing their own solutions and do not take a great interest in European approaches (or more likely have no liberty to do so). In an influential study on the automobile industry, the Massachusetts Institute of Technology (MIT) has introduced the expression 'lean production' to characterize the production system in the Japanese automobile industry. The production system is called 'lean' because it has cut away all the 'fat' in the factories. All waste has been eliminated and the result is a high level of productivity. The MIT study considers the Japanese production system as a new stage in the history of manufacturing, comparable to the introduction of methods of mass production by Henry Ford (the 'Fordist' system), in the early decades of this century. Characteristic of Ford is short-cycled work on the assembly line. Swedish alternatives to Ford's system have focused on the lengthening of the work cycles. Japanese work on the assembly line, however, has remained short cycled. This has led some observers to the conclusion that the Japanese approach is not an alternative to or a move beyond Fordism, but rather a kind of 'super-Fordism'. There are some important differences, however, between the Japanese approach and Ford's system. These

approaches both give more responsibility to production: responsibility for numbers, for quality, and for improvements. Whereas, the 'Fordist' approach was to take responsibilities away from production and to give it to specialized departments (e.g., for quality and maintenance), the Japanese gave line workers the responsibility for the quality of their products. In turn, the workers were given the possibility to stop the assembly line if they could not achieve required quality (e.g., because of faulty parts). All stocks of parts and buffers of product were systematically eliminated in order to make problems immediately visible. The most fundamental difference, however, is that production workers are also expected to contribute to the continuous improvement of the products and processes. They are expected to use every spare minute to think of possible improvements. Part of the improvement activities take place in special working groups called quality circles, where production people can interact with engineering and quality staff.

The idea of returning responsibility to production can also be found in the European socio-technical tradition. In the European tradition, it has been expressed by the notion of 'autonomy'. The autonomy of working groups implies that they are responsible for the results of their activities (within the limits that technical and organizational requirements impose). Autonomous working groups have a certain measure of independence, that is at the same time the source of their responsibility. Sometimes, this autonomy is accentuated by the presence of buffers, that separate the group from problems and interruptions in preceding or following production units. In the Japanese approach, this particular notion of autonomy is not present. There are no autonomous teams, because everything has been done to create an uninterrupted flow of product and all stocks and buffers have been eliminated. People in production are responsible for their own task and they assist each other if necessary. Western observers have called this 'team work', but it differs considerably from the team work in the European and North American socio-technical traditions. The Japanese notion of 'team work' refers to a sense of responsibility for the whole enterprise ('Team Toyota'), and to mutual aid and off-line improvement activities. As a consequence, the Japanese have also shown little interest in relocating indirect and staff tasks to production units. In fact, this could be a point where Western manufacturers have a competitive edge over their Japanese rivals, as the administrative and staff functions of Japanese car manufacturers appear to be relatively inefficient.

Considering these different traditions, it doesn't come as a surprise that Mitsubishi management found little value in the idea of production units as it had been developed at the Volvo plant. They preferred to return to an organization structured along functional lines. After considerable debate with the plant management, the production units were partly dismantled in

the spring of 1993. Further decisions will be made in the spring of 1994. All personnel functions, all finance/controlling functions⁹ and the larger engineering tasks (about half of the persons involved), have been taken away from the production units and returned to separate functionally specialized departments. What has remained with the units are some quality control and quality engineering functions, engineering tasks that are concerned with changes of the existing process (adaptations of purchased parts, changes in the product, adaptations of the layout), and maintenance. As we have seen, most of logistics had always remained a centralized function (under supply), and continues to be so.¹⁰ As a result of these changes, the unit managers had less staff to command (unit indirect functions diminished by at least 50 percent). This also allowed for the elimination of the function of head manufacturing in the unit. The unit manager became directly responsible for the production groups in his unit. More indirect functions may disappear from the units in the future, depending on the performance of the plant.

This discussion about the role of functional departments and the value of semi-autonomous production units has not affected the introduction of task groups. Task groups are still the main mechanism by which management hopes to create motivation and support for increases in productivity. As mentioned before, the plant and its new owners have committed themselves to the achievement of considerable improvements in productivity towards 1995. In early 1992, the plant management developed a preliminary 'Improvement Plan', that was presented to the employees in the summer of 1992. A more complete and updated version was presented in the summer of 1993 under the title: 'Continuous Improvement Plan 400', setting improvement targets for the production units and for production as a whole in relation to current production (the Volvo 400 series). The plan will continue to be updated every six months.

By 1995, NedCar hopes to produce 'twice the number of cars with the same number of people'. This aim was proclaimed after Mitsubishi had stepped in. Part of that increase in productivity will be reached by higher levels of automation. Part of it by working harder, and with more discipline. In an interview published in the plant newsletter in the summer of 1993, the plant manager complained that 15 to 20 percent of the workforce is still showing insufficient motivation. He makes it clear that improvement is expected; otherwise these people will have to leave the firm. Another sign of tightening discipline is a complete ban on smoking on the job. In the meantime, Takehara is quoted in the newspapers as saying that motivation is demonstrated by a willingness to stay a little longer on the job if necessary.¹¹

Obviously, not all, nor even a majority of the required gains in productivity will be achieved by working harder. Apart from automation, a major contribution will have to come from the new design of the cars. It is reported

that one of the first impressions that visiting workers had of the Japanese production lines, was that all parts fitted much more easily than at home. This clearly is a result of close interaction between production and design and development, both at the stage of product development and later, after the product has gone into production. Starting in the fall of 1993, production workers are going to Japan for visits of six to eight weeks in duration. They will be trained on the production lines that will later be installed in Born. Altogether, about 10 percent of the work force will receive training in Japan. Production managers (heads of production groups and area leaders) have also visited Japan and often returned with great enthusiasm for the idea of Kaizen (continuous improvement). Apparently, there is little reflection in Japan on the problems of launching and implementing improvement activities in an old plant with a sceptical work force in Europe. Manager enthusiasm, it would seem, can easily lead to disasters comparable to the 'New Style' activities described above.

Conclusion

The history of the plant in Born is one of permanent change, if not permanent crisis. Volvo came as a saviour, when DAF could no longer support the plant. The Dutch state intervened, when Volvo showed insufficient interest. And now Mitsubishi has come to save the plant again. Continuous improvement in a Dutch automobile plant? Was Volvo better than DAF? Is Mitsubishi an improvement over Volvo? Useless questions for a plant that is struggling for survival. There is no choice. If this doesn't work, nothing will.

Notes

1. For the following historic overview, extensive use has been made of the illuminating survey article by Greif and Meijer (1993). For the history of DAF Car BV, see also Van Diepen and Dankbaar (1990).
2. This situation is currently changing. The Helmond offices will be closed and all staff functions and engineering activities will move to Born.
3. The question if and what supply functions should be managed separately or controlled by production is subject to recurrent debate throughout the industry and different solutions are being practised.
4. The main rules for (re)design are:
 - a. First design the production structure and then the control structure;
 - b. The production structure has to be designed top down (from the perspective of the demands made on the organization); design aims at simplification by segmentation and parallelization, creating semi-autonomous organizational units;

- c. The control structure has to be designed bottom up (control functions should be located as low as possible in the organization);
 - d. Decisions on process technology should be made after the production structure has been decided;
 - e. The information system should be developed after the control system has been designed (in order to provide the information where it is needed to carry out control functions).
5. Doubts about the ability of workers to do materials management tasks were effectively eliminated when it turned out that more than half of the workers had a personal computer at home.
 6. The process of introducing task groups has been greatly disturbed by the almost continuous need to reduce the workforce in view of the downturn of the European car markets since 1989. The creation of teams requires a minimal level of continuity in the composition of the teams as well as time for training.
 7. In most car factories there are areas where most workers have only limited capabilities. In the creation of task groups, such areas have consciously been incorporated into larger, more varied entities. This may limit the possibilities for job rotation, if workers are unable to learn additional tasks, but it prevents the creation of low capability, low motivation ghetto's in the factory, with possibly severe impact on quality.
 8. It should be noted that these are averages and there is a large variation between the levels individual groups and workers have achieved.
 9. Finance and controlling tasks carried out by the production units included multi-year planning and budgeting, periodic reporting, task analysis, management information and controlling.
 10. Production schedules are developed by Supply on a day-to-day basis. Production is only free to schedule the sequence of cars within the daily schedule.
 11. Contrary to European practice, Japanese automobile plants have a gap of several hours between shifts. This gap is regularly used (without prior notification), to finish production according to plan, if the normal working time has been insufficient because of a breakdown of equipment.

References

- Diepen, B. van and Dankbaar, B. (1990), 'Volvo Car BV: Gedaantewisseling van een Borns bedrijf', in: J Soeters et al (ed.), *Het nieuwe Limburg. Herstructurering en ontwikkeling*, Scriptum, pp. 164–184.
- Greif, B. and Meijer, H. (1993), 'DAF schakelt terug naar jaren zeventig', *NRC Handelsblad*, 22 February, p. 12.

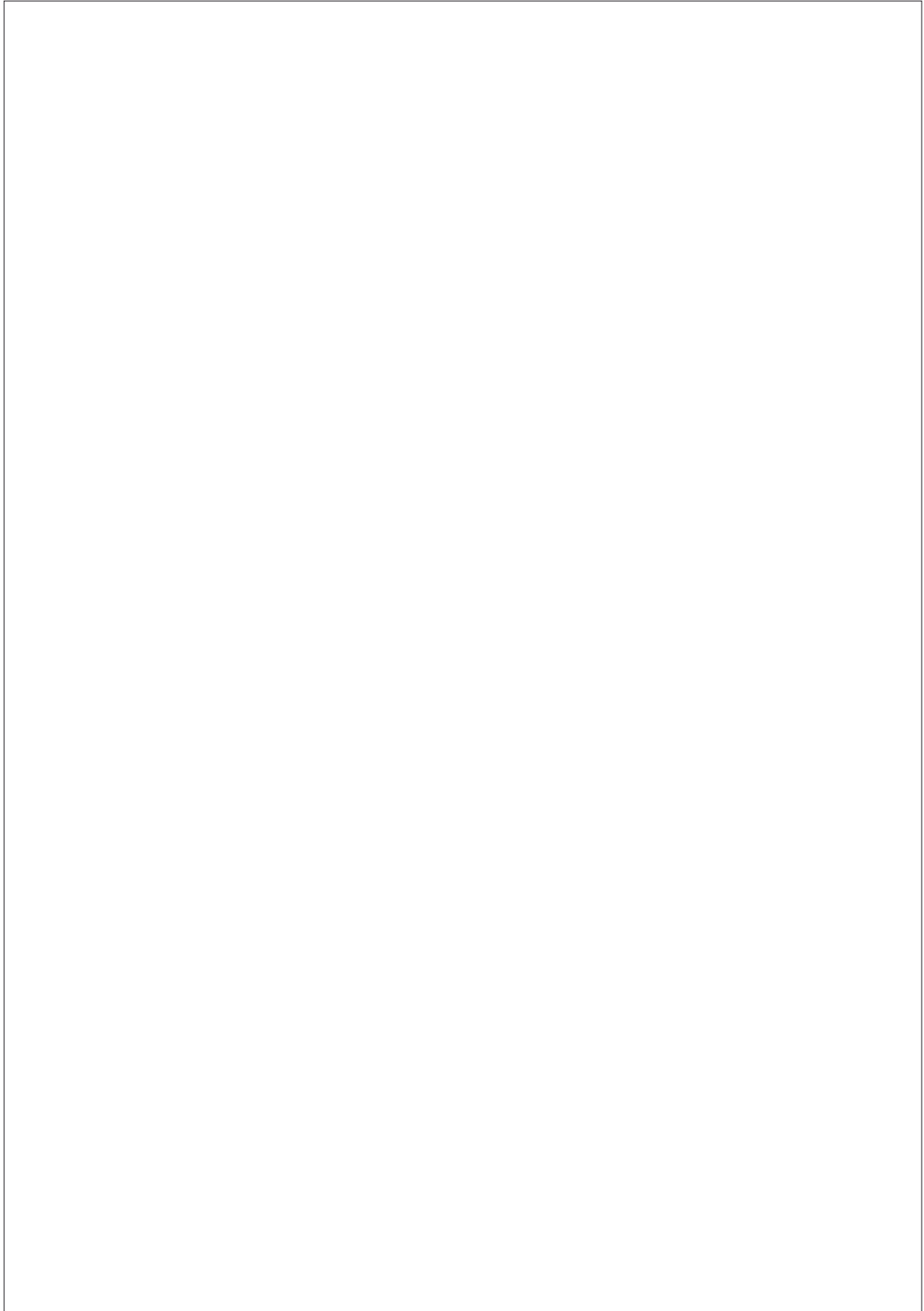

Missing the road:

Working life at Volvo Nova Scotia¹

L. Anders Sandberg

A Scandinavian king casts about for a handsome young prince worthy of the hand of his daughter, the beautiful Princess Asa, and finds two anxious suitors. To choose between them, he devises a contest that pits the suitors against one another in a race to build a castle. One contender uses cheap materials and mistreats and browbeats his workers in an effort to speed construction. The other, the valiant Prince Volund, opts for only the best of supplies and attracts skilled workers by offering excellent pay and working conditions, and even a medieval form of profit-sharing. Happily, Prince Volund is declared the winner of the contest, he and Asa marry, and, we expect, they live happily ever after. This tale was told in an advertisement appearing in major North American business journals and paid for by Volvo in 1984.² Though perhaps tainted by the recent closures of the Kalmar and Uddevalla plants, the tale still conveys some of the hallmarks of the Volvo philosophy: quality in workmanship, product and work environment.³ But what happens when Volvo establishes operations in a peripheral region, in the economic hinterland of North America, namely, Nova Scotia, Canada? This paper tells the tale of Volvo's automobile assembly plant in the cities of Dartmouth and Halifax, Nova Scotia, from 1963 to the present. The paper provides a brief description of Nova Scotia as a peripheral region and the concessions extended to Volvo over the years by various levels of government. It then suggests that these conditions are also reflected in the work organization and labour climate of the plant. Here, in spite of the presence of a powerful national union and relatively high wages, Volvo has 'missed the road' of its official philosophy. Its strategy is more akin to 'despotic Taylorism', where ever-higher levels of work intensity are forced rather than negotiated.⁴

The setting: Volvo in Nova Scotia

Nova Scotia is the third smallest province by population in Canada, with a history of economic underdevelopment, and staple production based on fishing, forestry, coal mining and crude steel-making. In the late 19th and early 20th centuries, the steel and coal industries boomed and militant union workers made substantial gains, only to see the regional economy collapse in the 1920s. Out-migration, high unemployment and declining labour militancy have since prevailed.⁵ By the late 1950s, its coal and steel industries were in a poor state, and various regional policies were developed by the federal and provincial governments to bring large transnational corporations to the province. Volvo was part of that development scheme. The Canadian federal government provided the trade inducements to attract and maintain Volvo in Nova Scotia.⁶ In the protectionist climate of the early 1960s, it permitted Volvo the duty-free importation of all components for assembly. The plant was set up as a so-called PKD (partly knocked down) assembly plant, where all components, even complete and painted car bodies (hence the term 'partly') were imported from Europe. In 1965, the Canada-United States Auto Pact was signed. This allowed the duty-free importation of auto parts to be assembled in Canada, provided the assembled cars contain sixty per cent Canadian content. Volvo was exempted from the latter requirement, with the expectation that forty per cent Canadian content be reached at some stage. But the company has been allowed to continue to import most material from Sweden in exchange for operating and employing Canadian workers in peripheral Nova Scotia. In 1988, 95 per cent of all assembly components for the 740 series Volvos came from overseas.⁷ Labour is clearly the most substantial Canadian content. But it is difficult to determine the amount because Volvo does not disclose the percentage of value added to its assembled cars in Canada.⁸ Volvo has clearly saved on the duty remissions, though it claims profits are lessened by the extra expense of shipping components, as opposed to finished cars, to North America. The tariff on imported cars was 17.5 per cent in 1963 and 12.3 per cent in 1983. In 1988, it stood at 9.2 per cent.⁹

Assembly in Nova Scotia is but a drop in the bucket of Volvo's global production. In 1963, 1,139 units were assembled in the province. In 1973, peak production was reached, at 13,000 units.¹⁰ Since then production has varied from about 7,000 to 12,500 annually; in 1990, 8,100 rolled off the line in Halifax while Volvo manufactured 376,100 cars globally.¹¹ In 1994, 24 units a day were assembled of the luxury 940 model, which amounts to less than 7,000 units annually. Exports to the United States have steadily increased as tariffs have come down. In 1988, the import duty on cars shipped to the United States stood at 9 per cent, down from 11 per cent a year earlier.¹² In 1992, the import duty had been lowered to 2.5 per cent.¹³

Exports to the United States began in 1968, amounting to one third in 1983, and one half in 1988, of total production.¹⁴ In early 1994, almost all units were exported to the United States.

Provincial and local governments also provided locational incentives to Volvo. When a new provincial government took office in 1956, it created a crown corporation, Industrial Estates Limited (IEL), to solicit and provide incentives for transnational corporations to come to the province.¹⁵ IEL was instrumental to the coming of Volvo to the twin cities of Dartmouth and Halifax in 1963.¹⁶ Volvo's initial operations were set up on a three-year lease in an abandoned sugar refinery on the Dartmouth side of Halifax Harbour. The lease was secured on favourable terms from IEL, and the city of Dartmouth contributed with municipal tax concessions.¹⁷ When the three-year lease expired, Volvo was lured to a new site, Pier 9, on the Halifax waterfront with new tax concessions and a \$1 million grant from IEL.¹⁸ In 1987, a third plant, designed to assemble the newer and more complicated 740 and 760 series, was built in the new Bayers Lake Industrial Park on the outskirts of Halifax, located conveniently next to railway lines providing access to the wider North American market. Volvo built this plant itself for \$13.5 million, but enjoyed a new round of municipal tax concessions and the city's promise to buy the plant, should Volvo decide to leave at any time after fifteen years of operation.

Volvo's operations in Nova Scotia are clearly tiny and simple by world auto industry standards. But the plant means a lot to the local economy, as is evidenced by the measures taken by the federal, provincial and municipal governments to attract and maintain the plant in Nova Scotia. Volvo has exploited its status frequently by threats of closures. These have been particularly common during labour disputes and the negotiations about concessions with municipal and provincial governments. Workers have continuously lived in a climate of uncertainty and, as one manager once put it, the notion that 'the future of the Halifax operations will be influenced strongly by *you* and your way of keeping good order as well as contribution to the efficiency'.¹⁹

Technology, labour organization and work environment

Management's account of the technological status, labour organization and work environment at the Volvo plant in Halifax conveys an unqualified success. Only two major legal strikes (1974 and 1988) have occurred at the plant. In a fairly typical statement, management describes the work force as exemplary, with low turn-over and absentee rates, and high quality ratings for workmanship based on Volvo's own standards.²⁰ The most recent strike, management refers to as 'gentlemanly'. Such scattered references

give the impression that the plant is 'a little bit of Sweden in Canada'.²¹ A more detailed look at the plant produces a very different picture.

When first set up in 1963, the assembly process in Dartmouth consisted of two parallel lines, each 57 metres long, with 12 work stations on each. Line 1 was the trim line, where sealants, sound deadenings, compounds and body trim were installed. Heaters, dashboards with protective foam padding, headlining, fuel tanks, electrical fittings and steering gear were also fitted at this stage. At the end of the trim line, the bodies were picked up by an overhead conveyor and transferred to the final assembly area, which began with the 'high line'. Here engines, rear axles, transmissions and suspension components were fitted into place and at the end the unit would be supported on its own wheels. The unit then rolled onto a 'lift' which lowered it to the normal working level for alignment, final assembly and inspection.²² The move to Halifax's Pier 9 in 1967 changed very little in assembly technology. The plant was bigger, but the assembly line remained the same, being shipped by truck and set up in Halifax during a 10 day break in production. In time, some improvements were made. Some so-called tilt stations were introduced, which allowed workers to install components from the side rather than from under the units. More improvements were made at the new plant in the Bayers Lake Industrial Park in 1987. The tilt-stations were implemented on a full scale, the layout of the plant made wider, with windows all around and materials stacked vertically rather than horizontally (as in the old plants). The assembly-line was thus longer and S-shaped rather than U-shaped. Some robotics were employed to apply glue to and install windshields and to move and tilt the cars. The paint- and under-coating booths were isolated. Water-based paint was introduced and the fluid for the air conditioning system filled automatically. But it is, so one worker claims, still the same principle that applies. The cars are pulled by a chain (now located under the floor), some of the airtools from 1963 are still used, and workers still have to push the cars manually on the line (though there is a mechanism that give them a boost).

The work organization and labour climate have changed very little over the years. Top down management, along Taylorist lines, characterizes the division of labour within the plant. All work is organized by management. Supervisors or foremen oversee and control the work process. Jobs are defined meticulously and job positions are posted and assigned according to seniority among the unionized workers. Job rotation only occurs on an informal and sporadic basis. Shop stewards, elected from among the unionized workers, receive complaints about job duties and assignments, and forward grievances to a shop committee. Two unions have represented the workers over the years: Local 720 of the United Auto Workers (UAW), an international union, from 1963 to 1985 and Local 720 of the Canadian

Auto Workers (CAW), a national union, from 1985 to the present. From the very beginning, the members have adhered to a solidaristic wage policy, arguing that it takes every worker's participation to assemble a car. Though wage disparities have increased over time, they remain low. In 1993, the highest and lowest hourly rate was \$18.18 and \$17.63, respectively.²³ The level of skill in the plant is relatively low and can easily be picked up. Job classifications vary and have a distinct pecking order. The least desirable jobs are on the assembly line, where the stress in 'chasing cars' is the most intense. The jobs off the line are the most desirable, such as subassembler, who prepares components for the assembly line, inspector, and adjuster. Some dirty and hard jobs are also desirable because they generate a lot of over-time work, something coveted by many workers.²⁴

The labour climate was initially peaceful at the plant. Workers recall the first production manager at the Dartmouth plant as respectful and caring. 'He knew everybody by their first name and knew when somebody had been sick or had a baby'.²⁵ In September 1963, the UAW and Volvo reached its first three-year agreement, ratified by 98 per cent of the workers. Though wages were not competitive with other Canadian auto assembly plants, the workers were promised 'that when its production and new plant facilities reach a position comparable with the rest of the automotive industry in Canada, it is intended to be competitive in every way and treat its workers accordingly'.²⁶ But the labour climate soon hardened, taking on the shape of despotic Taylorism. Management took several unilateral measures to circumvent the contractual agreements. On several occasions, it attempted to substitute seniority with ability and safety in assigning job duties.²⁷ It introduced additional and altered shifts in contravention of collective agreements and then used the extra workers hired as bargaining chips to have the shift changes stick.²⁸ Supervisors were used to perform workers' jobs.²⁹ Workers were reprimanded and threatened with dismissals when failing to keep up with the assembly line.³⁰ All warnings were recorded in writing and put in employees' personal files.³¹ Work premises were too cold.³² Work stoppages were frequent as a result of supplies being delayed from Sweden.³³ At least two wildcat strikes (and some near misses) were part of the industrial relations climate of the 1960s. Matters were not helped when a new manager was recruited from Ontario to, as one worker recalls, 'teach those farmers and fishermen a lesson'. In 1969, the Union President wrote that the production manager was 'commonly known as Hitler and his foremen as little Hitlers or his SS men'.³⁴ The workers believed firmly that management was trying to provoke a wildcat strike, something that would have resulted in heavy fines for the union.

The labour situation did not improve in the 1970s when the Volvo Corporation as a whole was in a difficult situation, both in producing a quality car

as well as in identifying a distinct market niche. The workforce nevertheless grew slowly to 1976. But then, in 1976, the workforce was reduced from 240 to 160 employees.³⁵ Only some workers were re-hired after this layoff.³⁶ The plant also experienced temporary closures, such as in 1977, when it closed for ten weeks due to sagging sales.³⁷ A 13-week strike in the summer of 1974 tells part of the story of the issues contested during the 1970s. The main issues were wage parity with Ontario auto assembly plants (a long-standing demand) and voluntary overtime. 'With lots of men to work overtime ... I cannot understand why the company insists on compulsory overtime', one union official stated. Management countered that compulsory overtime was necessary 'to ensure that the plant remains in continuous operation', but promised that overtime be limited to 8 hours per week and that no worker be scheduled for overtime two days in a row. After initial rejection by a small margin, a contract was approved by an 80 per cent majority of the workers. Some gains were made but the stand that 'no compromise will be accepted' on the overtime issue had to be abandoned.³⁸ The over-time issue had a deeper political significance as well. Before 1974, as well as after (to the extent that it has been possible), workers have informally refused overtime work under contract negotiations, mainly to show support for its negotiators. Such action caused considerable friction during the contract negotiations in 1966 and 1969.³⁹ The agreement of 1974 allowed management more flexibility in assigning over-time work.

The problem of job assignments continued into the 1970s. It is well illustrated by the strain put on shop stewards. In 1974, one shop steward resigned from the plant committee, feeling it was 'no longer an effectively working body: grievances are dropped, delayed or forgotten for no apparent reason'.⁴⁰ Another shop steward, upon resignation, felt that 'the majority appear to see [him] as one to complain to and expect him to right all wrong immediately ... a source of letting off their frustration without jeopardizing their image to the foreman or other Management officials'.⁴¹ At the time, one union official felt that the union, especially the shop stewards, had become whipping boys, blamed for everything that went wrong.⁴² Such friction was lessened by a reorganization of the shop steward system in the early 1980s. From a wider perspective, the friction within the union needs to be seen in the context of 'despotic Taylorism', and the divide-and-rule strategies that are often part of this system.

Increased work intensity has characterized work organization and work on the assembly line since the late 1970s. A new system was introduced for determining the time for each work cycle on the assembly line. The time clock gave way to time and motion studies, making no allowance for mistakes, individual worker differences (size, weight, height) or different qualities of movements. For some workers, with long distances to walk,

the intensity of work diminished while for others, who were stationary, the intensity of work increased. On the whole, with subsequent adjustment, the new system had the effect of speeding up the work and adding stress. The previous 'breathing space' between work cycles which helped to relieve stress – and allowed the odd word to be exchanged by workers – disappeared. The duration of work cycles at the Dartmouth and Halifax plants have fluctuated widely over the years. The work cycles appear to be determined mainly by production and the number of workers employed rather than to factors relating to an optimal human-centred work environment. In the beginning years, the work cycles were long, because employment and production was low. Then, in the mid-1970s, when peak production occurred, the work cycles were from 6 to 8 minutes long. In 1988, the work cycles were 13 minutes. In 1994, they had increased to 20 minutes. Management argued – following the Uddevalla model – that the longer cycle slows the assembly line, decreases stress and adds variety to the job task. The Volvo workers Halifax feel differently. When the Halifax plant built 60 cars per day, 'it was a breeze', more workers were employed, the time cycles were shorter and the job tasks easier to perform.⁴³

Increase in work intensity and down-sizing are well illustrated by the move from the Pier 9 site to Bayers Lake Industrial Park in 1987. It resulted in two bitter strikes: a wildcat strike in 1987 joined in by most workers and a 5-week strike in 1988, where workers voted 111 to 1 in favour of strike action.⁴⁴ The workers obtained some wage increases and the indexing of pensions. The persistent frustration relating to line speed and workload, however, were equally important in precipitating the strikes. Workers speak bitterly about the move to the new plant in 1987. One utility worker – who fills in for sick workers, relieves temporary absentees and helps to ease bottlenecks on the production line and subassembly – felt that the assembly line was understaffed ('a very tight ship was run'). Management tried to keep the assembly line moving, no matter what the cost in quality and human frustration, to reach the target of 36 cars per day. Utility workers spent 4–5 hours per night building parts (subassembly) for next day's production. Quality suffered, absenteeism increased and the general frustration level mounted. The utility workers, much to their distress, had to fill in for absentees. Their compensation was low because of the solidaristic wage policy. This posed frustration among the utility workers who – in a stressful and labour-scarce work process – felt 'suckered' and exploited for having upgraded their skills. Quality controls became stricter and the level of tolerance for errors diminished at the new plant. They posed additional aggravation, as workers struggled to assemble the more complicated 760-models, which contained 33 per cent more parts than the previous models.

All directives came from the top management during this difficult period.

One management representative who acknowledged the shortage of workers during the initial phase of the move to the new site in 1987, and who was then proven right by outside consultants, was summarily fired. The foremen had no authority and were of little help. The general feeling among the workers was that there were too many foremen, and that 'they had time on their hands'. The workers were always at fault. Planning and decision-making, as is a major characteristic of Taylorism, have continued to come from the top at the new plant. At one point, the location of time clocks was changed to facilitate supervision, but workers were inconvenienced because time-clocks and work stations ended up at opposite sides of the plant. Routinely, new versions of cars were introduced on the line without workers being notified. Although training programs and operating and repair manuals for certain equipment were available free from manufacturers, these were not available to workers. Getting a union office at the new plant location (as the union had at Pier 9) was a two-year struggle at the new plant. At Volvo, 'a worker stays a worker', states one worker. Another, who once worked with Swedish line workers and engineers at Torslanda, claims that Swedish workers 'wouldn't have anything to do with the interference and requests put on us here'. 'There is no use trying'. 'When we complain they say they will look into it but they never do'. The problem thus continues: 'It's like a time bomb ready to explode at any time'.

Hiring practices at the plant tell a similar story. It remains a closely guarded management prerogative, except for recalls of laid-off workers which follow the seniority principle.⁴⁵ In 1988, the company received approximately 60 applications per month.⁴⁶ In the same year, however, a woman, Mary Ritchie, who had sought employment with Volvo since 1972, took the company to the Nova Scotia Human Rights Board of Inquiry, charging the company with gender discrimination in hiring. After two successful attempts by Volvo lawyers to delay the hearing, it took place in 1990. After half a day, Volvo settled privately with Ritchie. The company agreed to pay her \$43,000 for general damages. It agreed to offer her the first available assembly-line job after receiving a two-year certificate from a community college in automotive mechanics or auto body repair. It also agreed to embark on a policy of employing 15 per cent women, the national standard, once all male workers from the recall list had been re-hired. Finally, the company agreed to display a scroll describing human rights in a public place at the plant.⁴⁷ In spite of these apparent concessions, the company claimed victory, arguing that the settlement 'sends a message to all employers that they can exercise their right to hire the best qualified applicant'.⁴⁸ There are perhaps several explanations. The stipulation that Ritchie take a two-year training course is something that has not been required of any previous employee.⁴⁹ Since 1990, there has been very little opportunity for women to gain employment

at Volvo. In 1992, the workforce was reduced to 135 people as a 'cost-cutting' measure, and the number of units assembled per year was reported at a low of 7,000.⁵⁰ In 1994, 113 workers were employed. There are still (in April 1994) no women workers at the plant.⁵¹ Nor is there a scroll explaining human rights displayed at the plant.

There are several reasons why Volvo workers in Nova Scotia stay in what appear to be less than satisfying jobs. The wages are high by Nova Scotia standards. There is little else to do. The workers are relatively old and know few other skills; in 1988, the average age at the plant was 42 years. In 1994, the average age was close to 50 years. These are facts of which the workers are critically aware and constantly reminded by management.

Conclusion

The Volvo assembly plant in Nova Scotia is clearly an enclave factory, dependent on distant components for assembly and distant markets for ultimate sale. Concessions brought the plant to the province, and concessions continue to keep it there. But there is no love lost between the local management and their workers. Under the official veil of harmony there is considerable frustration. The workers have little good to say about their employers.

How do we interpret this situation? Is it a mere reflection of the adversarial nature of Canadian management-labour relations? Do conditions in Nova Scotia necessitate a different mode of operation than in Sweden, given a peripheral location and tumbling tariffs? Is consultation with labour too costly in Nova Scotia? Is it more profitable to run an operation from the top down regardless of the resultant acrimony? Is local management pressured by Volvo headquarters to act as they do? Does the high unemployment rate invite tougher and less democratic working standards? Does the presence of a strong national union, which has helped workers to obtain near national standard wages, at about \$18 per hour, necessitate despotic Taylorism in the work place? A squeeze on profits no doubt plays a role but not a determining one. Volvo Canada has had some hard years but so has the Volvo Corporation as a whole. In 1992, it declared a loss of \$1.1 million. But the years 1984 to 1989 were highly profitable, with net incomes ranging from \$8–12 million.⁵² In 1985, the profit of \$12 million on \$268 million of sales 'gave Volvo the best return on invested capital of any major company in Canada, according to Financial Post 500 rankings'.⁵³ The answer is most likely to lie in the concessionary climate in which the Volvo assembly plant in Dartmouth and Halifax was conceived and then maintained. Such concessions are also expected from the work force, a work force which is instrumental in making the Nova Scotia plant most productive of all Volvo's assembly plants. The

wider lesson of Volvo's plant in Nova Scotia for work place reform is not promising. There are at least two plausible scenarios.

Within the last couple of months, Volvo management in Halifax has introduced, but not implemented, a new program based on teamwork and quality control. It is based on teams working in four, and then being responsible for quality control as a group. This trend towards Toyotism is viewed with skepticism by many workers.⁵⁴ Perhaps it is an effort to improve productivity and maintain the plant, in spite of the falling tariffs that brought Volvo to Nova Scotia in the first place. A second scenario is less promising for the future of the plant in Nova Scotia. In 2002, Volvo is free to abandon Halifax with a government guarantee to buy back the plant. By that time it is likely that tariffs will be close to zero. Moreover, the average age of the highly productive work force will be approaching 60 years, if no new workers are employed. There are no signs of the latter occurring today, in spite of the importance to train new workers for the long-term viability of the plant.⁵⁵ The implications of the Ritchie agreement for the employment of women and the training of workers generally at the plant suggest that Volvo has no intentions to employ new workers. The turn of the century, in other words, may be an opportune time to leave.

Volvo did not bring a 'little bit of Sweden' to Nova Scotia; instead, the company quickly adopted to and exploited the peripheral conditions of its new location. If there is a future for Volvo in Nova Scotia, this is likely to continue. If Prince Volund is in charge of Volvo's operations in Nova Scotia, he will probably not gain his Princess but remain a bachelor to his grave. And, if Kalmar and Uddevalla are now at the end of the road, Halifax seems to have missed it altogether.⁵⁶

Notes

1. I would like to acknowledge the helpful comments by Don Wells, Labour Studies Programme, McMaster University. I am also grateful for the insights provided by Percy Seal, former president of Local 720, Canadian Auto Workers [CAW], and Larry Wark, Maritime representative for the CAW.
2. On the closures, see Sandberg, Å., 'Volvo: Human-centred Work Organization - The End of the Road?', *New Technology, Work and Employment*, 8, 2 (September 1993), pp. 83-87.
3. The journals included *Financial Post*, *Wall Street Journal* and *Forbes Magazine*. The advertisement cost Volvo \$364,000 and was intended, so the company claimed, to 'familiarize people with the Volvo way of thinking'. *Gazette* (Montréal), 6 December 1984.
4. Adler, P.S. and R.E. Cole, 'Designed for Learning: A Tale of Two Auto Plants', *Sloan Management Review*, 34, 3 (Spring 1994), p. 90.

5. For a recent statement, see Forbes, E. and D. Muise, editors, *The Atlantic Provinces in Confederation* (Toronto: University of Toronto Press, 1993). For the waning of labour militancy, see O'Brien, P.F., *The Myth of Labour Instability: Nova Scotia Versus Competing Jurisdictions* (Halifax, 1980).
6. The details are provided in The Volvo Research Group, "'A Little Bit of Sweden': The Volvo Story in Nova Scotia," *New Maritimes*, VII:5 (May/June 1989), pp. 14–23.
7. *Globe and Mail* (Toronto), 24 December 1988.
8. *Toronto Star* (Toronto), 15 April 1987.
9. *Toronto Star*, 15 April 1987 and *Financial Post* (Toronto), 2 July 1983.
10. *Financial Post*, 19 November 1977.
11. Volvo Car Corporation. *Facts 1991*.
12. *Globe and Mail*, 24 December 1988.
13. *Globe and Mail*, 14 July 1992.
14. *Chronicle Herald* (Halifax), 10 June 1983 and *Globe and Mail*, 24 December 1988.
15. Some came and stayed, such as Volvo, American Scott Paper, Swedish Stora Kopparberg AB, and the French Michelin Tire Corporation. Others proved scams, or flighty ventures, which quickly closed and left. Social institutions were also copied from abroad, such as the formation of a joint labour-management board (based on Swedish principles) and a joint stake-holder industrial planning forum (based on French precedent). These were largely unsuccessful, mainly because of the province's accommodation of the transnationals. See Earle, M., editor, *Workers and the State* (Fredericton: Acadiensis Press, 1990). The most famous case is the so-called Michelin Bill of 1979, which prevented the unionization of Michelin Tire, the largest private employer in the province. M. Bradfield, 'Michelin in Nova Scotia', *Canadian Forum*, LXI (December-January 1981-82), pp. 9–11.
16. Halifax is the capital of Nova Scotia, and possesses the closest North American ice-free port to Gothenburg. Dartmouth, its sister city, lies opposite Halifax Harbour, and is connected to Halifax by two bridges.
17. The details are provided in The Volvo Research Group, 'A Little Bit of Sweden'.
18. *Mail Star* (Halifax), 15 April 1967.
19. Emphasis in original. Lindblad (Plant Manager) to Irving (Union President), 28 February 1969. United Auto Workers [UAW] Papers, MS 9, 5, File 12d, Dalhousie University Archives.
20. In 1980, the plant was reported to have 'the best productivity of all Volvo's plants'. Absenteeism was reported at 5–6 per cent and the turnover rate at 6 per cent. *Financial Post*, 2 August 1980. For identical claims, see *Chronicle Herald*, 3 June 1983 and Volvo, *Volvo North America Corporation*, 1990, p. 9.

21. *Globe and Mail*, 24 December 1988.
22. *Chronicle Herald*, 11 June 1963.
23. 'Collective Agreement Between Volvo Canada Ltd. and CAW Local 720', 31 March 1991, p. 56. No trades people or trades wages rates apply to the plant. Comparative figures for the 'Big Three' automobile assembly plants in Ontario, Chrysler, Ford and General Motors was \$20.85 to \$20.86 for an assembler and \$25.03 for an electrician (trades rate). Information from CAW Office, Toronto, 29 June 1994.
24. 'Collective Agreement Between Volvo Canada Ltd. and CAW Local 720', 31 March 1991, p. 56.
25. Statements of workers and union officials, unless otherwise stated, are based on interviews performed in 1988 and 1994. I am especially indebted to former President of Local 720, CAW, Percy Seel, and Maritime representative of the CAW, Larry Wark.
26. *Mail Star*, 26 September 1963.
27. Grievance, 15 June 1967. UAW Papers, MS 9, 5, File 12a.
28. Shop Committee Report, January 1965. UAW Papers, MS 9, 5, File B1
29. 'Notes of Meeting Between Management Volvo and Plant Committee', 4 September 1969. UAW Papers, MS 9, 5, File 12d.
30. Irving to Durocher, 4 December 1967. UAW Papers, MS 9, 5, File F5.
31. Harse to McGrath, 8 November 1971. UAW Papers, MS 9, 5, File F12e.
32. Irving, 13 December 1965. UAW Papers, MS 9, 5, File F12a.
33. Shop Committee Report, 15 March 1965 and Irving to Hiller, 24 October 1965. UAW Papers, MS 9, 5, Files B1 and F5.
34. Irving to Dean, 11 April 1969. UAW Papers, MS 9, 5, File 5
35. *Chronicle Herald*, 1 April and 19 June 1976.
36. *Chronicle Herald*, 11 May 1979.
37. *Mail Star*, 11 June 1977.
38. *Chronicle Herald*, 22, 26 June; 12, 22 August; 9, 11, 14 September; 1974.
39. Irving to Ostergren, 30 November 1966 and Irving to Lindblad, 30 April 1969. UAW Papers, MS 9, 5, File 12a.
40. Seel to Plant Committee, no date but circa 1974. UAW Papers, MS 9, 5, File A4.
41. Monk, 9 March 1976. UAW Papers, MS 9, 5, File B3.
42. Kennedy, 24, 25 October 1976. UAW Papers, MS 9, 5, File C1.
43. Cole and Adler, drawing on NUMMI, claim there is nothing intrinsically dehumanizing about narrow tasks performed in short work cycles. The Halifax situation suggests that there is nothing intrinsically humanizing about more

complex work tasks performed during longer working cycles. Both are subject to broader workplace conditions. Cole and Adler, 'Designed for Learning', p. 91.

44. See *Mail Star*, 26 August and 30 September 1988.
45. Though workers remain on recall lists for only two years after layoff.
46. Affidavit. Volvo Canada Limited, Applicant, and Mary Ritchie and the Nova Scotia Human Rights Commission, Respondents. Supreme Court of Nova Scotia, Trial Division, S.H. No. 66849, 1988.
47. 'Terms of Settlement: Volvo, the Human Rights Commission and Mary Ritchie', 8 May 1990.
48. *Toronto Star*, 9 May 1990; *Human Rights Advocate*, VI, 4 (May 1990), pp. 1, 6.
49. Nor is it necessary. This is readily admitted by the male workers and regretted by the legal counsel for Ritchie and CAW officials.
50. *Plant*, 17 August 1992.
51. In Uddevalla, by contrast, 40 per cent of the workers were women. Sandberg, 'Volvo: Human-centred Work Organization - The End of the Road?', p. 86.
52. Volvo Canada. *Financial Statements*, 1977-1992.
53. *Toronto Star*, 15 April 1987.
54. See, for example, Mike Campbell, 'Where are We Heading?', *720 Local News*, 10 (April 1994), p. 2.
55. There are, for example, no provisions for early retirement.
56. Sandberg, 'Volvo: Human-centred Work Organization - The End of the Road?'

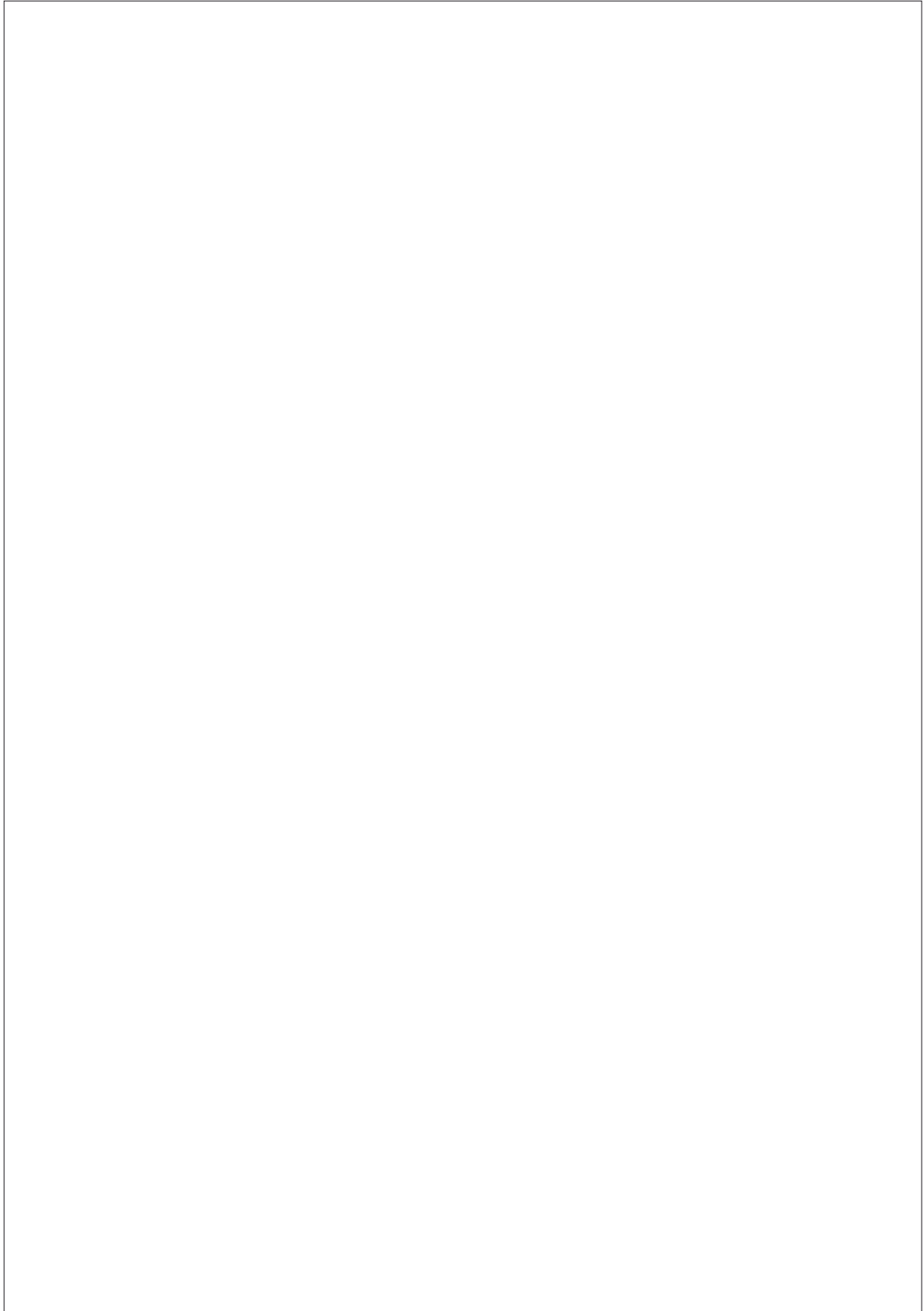

Volvo in Malaysia

Hing Ai Yun

Since its birth slightly over 100 years ago, developments taking place over the past one and a half decades can be said to be amongst the most dramatic in the whole history of the auto industry. The 1970s–1980s saw major restructuring of industry on a scale as big as ‘the pioneering efforts in mass production in the USA in the 1900s, or Europe’s introduction of sharp product differentiation in the 1950s, or Japan’s more recent innovations in production engineering management’ (Mortimer, 1987). The tortuous path traversed by the global automotive industry has indeed impacted differentially on various regions around the world. The inception and growth of Malaysia’s auto industry is a case in point.

Malaysia’s auto industry: inception

When Malaysia began thinking seriously about the production of automobiles in the 1960s, it had intended to use this to spearhead its industrialization drive. As a first step, it announced in 1966 that high tariffs, stringent import licensing and quantitative restrictions would be imposed to encourage the establishment of local assembly plants. Meanwhile, the years between 1960s and 70s were the high point of European car expansion. (Womack et al., 1990:44). With cheaper wages and new product features (like front-wheel drive, disc breaks, fuel injection and unitized bodies), the Europeans, after the Americans, had racked up success after success in foreign markets. It was only logical that a European company would be amongst the first assemblers to take advantage of Malaysia’s new tariff regime to establish plants locally. In effect, Swedish Motor Assemblies Sdn Bhd, a joint venture between AB Volvo and their local distributors Federal Auto Company Sdn Bhd (on a 50-50 basis) has the distinction of being the first assembly plant to be established in Malaysia. It is not coincidental that Volvo was the first.

In view of its very small population, Swedish relative to other European auto companies had to push hardest for exports to survive, chalking up between 80–90 percent of exports for 1986 (Malmberg, 1991). To keep its plants running all year round, Volvo had chosen to sell its winter production to countries with a different climatic regime. Additionally, to compete effectively, Volvo adopted the strategy of exporting only to countries without domestic production.

Since Malaysian automobile assembly companies were mainly established by major local distributors (in some cases through joint ventures with foreign automobile manufacturers) and in view of the fact that these distributors normally handle more than one brand, the assembly plants they established generally produce a wide range of models and brands under manufacturing licenses. Moreover, the original limit set by consultants (numbering 5–6), to ensure the maximum viability of plants in the country, could not be followed. Existing distributors were concentrated into the hands of the Chinese, so were the ownership of parts producers. In its push to redress the balance of economic power between the ethnic groups in Malaysia (which has a GNP of \$38,614 million [all denominated in Malaysian \$ equivalent to \$0.4 US] and a population of 18 million comprising 62 percent Malays, 30 percent Chinese) after the 1969 racial riots, the Malays had to be encouraged to participate in this new strategy for industrialisation. Thus the original number of six assembly plants set up in 1966–69, with the goal of progressive manufacture of component parts was later expanded to accommodate another five plants in 1977.

With a small market (Table 1 and 2), relatively large number of producers and an even larger range of models, the auto industry was operating under severe ‘diseconomies’ of scale. On top of this, mandatory local content increases (10 percent in 1972 to 35 percent in 1982), could not be implemented, partly due to the wide differentiation of parts and components which made it prohibitively expensive to produce parts locally. In 1980, the 11 assemblers were producing 25 makes, 122 models and 212 variants. By 1979, local content had averaged only 8 percent and was limited largely to tires, batteries, paint and filters (Malaysian Business 1 Dec 1984). One estimate noted in 1971 that ex-factory Malaysian prices exceeded British prices by as much as 22–52 percent (Lee 1971). Of course, part of the reason for not forcing the local content schedule was to accommodate the Asian complementation scheme, whereby, the manufacturing of parts would be parcelled out among member countries to maximize the utilization of plant capacity (Solidum and Seah, 1987).

Unfortunately, at that time the vehicle industry was not the only sector that was cumbersome and in need of a thorough restructuring. Indeed, the 1969 riots made it clear that the production organization of the country required

a thorough shake-up to yield a return that can support a population growth rate of 3–4 percent per annum.

Reconstituting the auto industry

The first step towards rationalization of the national productive apparatus was to transfer ownership of matured factors of productions (comprised chiefly of plantations and mines), from foreign to local hands. Only the state with command over rich resources like petroleum could buy and also initiate new enterprises, especially in the nascent industrial sector. In this respect, the Heavy Industries Corporation Malaysia (HICOM), was set up in 1978 to undertake the implementation of heavy industrial projects. The State's share in manufacturing value-added was estimated at around 24 percent, one of the highest ratio in the non-socialist world (UNIDO 1991:39).

The national car project (Proton), is a major component in HICOM's thrust towards heavy industrialization. Proton was initiated in May of 1983, by the present Prime Minister and is a joint venture between HICOM (29 percent), the Ministry of Finance (18 percent), and Mitsubishi Motor Corporation (17 percent), with the rest of the equity shared out with two other Malaysian institutions and the public. In a single stroke, it was hoped that with the establishment of Proton which costs \$230 million, the problem of low Malay participation in the motor industry (State ownership is equated with Malay ownership), and the moribund state of the auto industry could be repaired. The Proton was extremely privileged, being exempted from the 40 per cent import tariff while taxes for other CKD – packs (completely knocked down) were at the same time increased three times, leading to the treasury losing \$120 million in foregone import duties. Proton, therefore, had unbeatable prices. A 1300c.c Proton costs around \$21,000 while competitors were retailing for between \$28,000 to \$29,000. As a result, Proton's market share shot up from 47 percent in 1986 to 73 percent in 1988. Three assemblers including Mitsubishi had to shut down. The others either reduced production or even shifted to part exporting. In short, 3,500 workers lost their jobs. Now, there are 10 assemblers producing 200 models.

The ethnic dimension of the rationalization process also filtered down to the level of the plant. Proton in 1988, employed 1,300 workers of whom 94 percent were Malays. They were not unionized. Few of the experienced workers laid-off from the other plants (about half were Chinese), were hired. The experience of mass retrenchment served as an effective deterrent and disciplinary chain that immediately tempered the recalcitrant work force of the industry. On the part of the management, uncertainties involved in the whole restructuring exercise had bred such a sense of crisis and insecurity that they became even more authoritarian in handling the workers on the shopfloor.

Swedish motor assemblies Sendirian Berhad (SMA)

The SMA was started in 1966 and in its first year of production in 1967, had an output of 11 units. From this small number, the company proceeded to expand production to a peak of 9989 units in 1974. From then on, the number of units produced declined steadily to a trough of 351 units in the 1986 recession when the work force was down to 119 from a peak of 732 in 1975 (See Figure 1 and 2). Out of the 26 years for which data is available, the company was producing a higher proportion of non-Volvo cars (contract assembly), for 11 years. Currently, the company's production per day includes 8 units of Daihatsu (Delta), 5 vans, 3 Suzuki (2 models) 2 units of Volvo (Models 850 and 940). In 1992 (August), it employed around 450 workers of which only about one-third can be described as skilled. Labour turnover at the plant is about 7 percent.

The labour process and work organization

Material department

This department is headed by a manager who is assisted by a foreman, several charge hands and lower level 'seniors' who sit above the 'handlers', the numbers varying at different time periods. One charge hand is in charge of 10–20 workers. 6 out of a total of 40–50 workers are involved in administrative work in this department.

On receipt of a new model, the foreman and the charge hand would discuss the details of work procedures. Once these have been established, the foreman would just issue the orders to the charge hand who would then pass on the information/directives to the seniors, who would then pass it down the line to the handlers.

In this section, the CKDs that arrive are opened up by the senior material checker with the help of handlers. These are then arranged according to station sequence found at the production line. The parts are sourced both locally and from foreign suppliers. Daihatsu parts come from Indonesian and Japan, whereas, parts for the Volvo 850 come from Sweden. Renault parts originate in France. Local components are made up of parts like glass, tires, exhaust and batteries. Due to the low volume of production, it has become more expensive to source locally. Local content level is still low, at 40 percent for Volvo and 10 percent for the Daihatsu.

Production department

This is the largest department and covers several sub-divisions including:

1. Body Shop:
Welding Jig Area

- Metal Finishing
- 2. Paint Shop:
 - Electro Dipping
 - Underbody Spray
 - Sealing
 - Colour Spray/Dry Sanding
 - Paint Rectification/Plastic Parts Spray
 - CBU/Paint Rectification
- 3. Final Assembly Line
- 4. Rectification

Body Shop

About 60–70 workers are employed in the body shop. This department is divided into two sections whose details are provided below:

- a) Jig Area: The metal panels of the bodies are placed in specialized jigs fixtures, manually assembled and spot welded to fuse specific sections of the panels together. Each spot weld is subject to continuous checking. Volvo Sweden provides the designs and specifications for manufacturing the jigs. This, together with SPC (Statistical Process Control) combine to ensure that Volvo designated dimensions and tolerance are reached.
- b) Metal Finish Line: The vehicle body is finish-welded here using arc welding and brass welding. Joints and welded parts are then grinded in special enclosed booths designed to reduce the noise level in the factory and to prevent metal dust pollution. Finally, doors, bonnets and boot-lids are bolted onto the body to specified tolerances, followed up by SPC.

In the Body Shop, workers are grouped according to the models they work on. Their numbers with corresponding car models are shown below.

Table 1
Body Shop: Workers by Vehicle Model (1992)

<i>Vehicle Model</i>	<i>Jig No. of Workers</i>	<i>Finishing No. of Workers</i>
Volvo: 240	10	12
Volvo: 940	8	
Renault 19	6	
Suzuki	9	7
Daihatsu	13	4
Total	46	23

Paint Shop

In this shop, the body first undergoes pre-treatment: the body is degreased, rinsed and zinc phosphated. It then is electro-dipped (Cathodic Electro Dip process), to provide perfect penetration of the paint after which the body undergoes sealing. The body then proceeds to receive an intermediate coating which is then followed by manual spraying of the top coat by skilled painters. After passing through the topcoat oven it is inspected and any faults are then rectified. The paint shop employs about 70 workers.

Final Assembly Line

This part of the work process comprises several segments: The Trim Line, Body Drop, Final Line and Underbody Treatment. Here again, the workers are grouped according to vehicle model as shown below.

Table 2

<i>Vehicle Model</i>	<i>No. of Workers (Operators)</i>
Volvo: 240	32
Volvo: 940	12
Renault	12
a) Sub total:	56
Daihatsu: Delta	27
Pick-up/Van	24
Suzuki	17
b) Sub total:	68

(a) and (b) each with one chargehand

Trim Line is where the vehicle body is manually fitted with head-lights, tail-lights, bumpers, mouldings, grills, windscreens, door-glasses etc. The material handling system is designed to minimize the number of components handled along the line to reduce damage to components and also to allow for more room in the working environment. At the end of the Trim Line, the body now passes through the Body Drop Section. Here, the body is 'married' to the engine, transmission, front to rear axles using a tilt device specially designed by Volvo to allow a 90 degree tilt which permits easier assembly and inspection of all under carriage work. The vehicle then passes onto the Final Line where seats, carpets, trim mouldings, batteries and other accessories are fitted into the car. The carbon monoxide level is here checked to the minimum level required by legislation and before the car leaves the assembly plant, it receives a final rust protection treatment which involves spraying of anti-rust into the inside box and door sections of the car.

Rectification

This is considered the last stage of the production line where defects and shortages are identified and rectified. Here again, workers are organized to work on specific models.

<i>No. of Workers</i>	<i>Model</i>
7	Volvo 240 and 940
6	Daihatsu
2	Suzuki
3	Renault

They are managed by a supervisor, charge hand and leadmen.

To understand the way work is organized and managed in Malaysia, one has to take into account a few basic factors. First, is the country's very recent shift to waged work as a major mode of economic organization. As recently as 1975, only slightly above half (55 percent), of the population were wage earners. Second, the country has been struggling hard to stave off foreign domination of its economy. Having succeeded in decreasing foreign share of the agricultural sector, it is now trying to balance the need for foreign capital and technology and national autonomy in its effort to industrialize. Third, is the fact that, the auto sector is one of the oldest in Malaysia's manufacturing base. As such, we should expect it to possess more of the moribund vestiges of old industries. Capital restructuring is one big factor affecting the labour market and thus, is important in shaping worker behaviour in this sector.

In view of the remarks above, one can understand why jobs in the auto industry are therefore, generally specific, specialized, simplified, and highly routinized and labour intensive. New recruits are thus, easily absorbed onto the line with only a few days of on-the-job training. If a worker on the trim line has to fit the windscreen, that remains his job day-in-and-day-out until he gets shifted elsewhere to replace some absent colleague or gets promoted due to good/obedient behaviour. Job relationships are bureaucratic and hierarchical, with the foreman acting as the chief spokesman delivering managerial directives. This constitutes the primary and most common form of management – labour communication. Before the appointment of the current personnel manager (acting), there appears to be very little interest in training or what is now designated as 'human resource management'.

It would appear that strict and tight supervision remains the primary tool ensuring that production proceeds smoothly. In this, the foreman constitutes the key. Using the leverage of overtime work (which brings in more than the normal rate of pay-one and half times), the foreman is able to get workers to toe the line by bestowing this 'higher' rate work on the

favoured/selected few. There is very little joint-consultation. However, spurred by the introduction and 'successful' implementation of the Proton project, SMA, like other auto assemblies will likely introduce new methods into its management style. In fact, the foreman on whom much depends but whose supervisory capabilities are widely recognized as conservative and deficient, has become the first target for a new regime of training recently initiated by the personnel manager.

In the past, hierarchical methods of management were justified on the grounds that workers were largely uneducated and irresponsible. The average level of education of the workers is lower secondary schooling of about eight years. A strong national union had successfully gained benefits and higher than average pay for its members. The monopolistic position of the assemblers, prior to Proton, had also strengthened the position of labour to such an extent that absenteeism and malingering has become a perennial problem of production. Part of the reason for this 'undisciplined' work behaviour could stem from the very routinized, nature of the work. In fact, certain sections with heavy, arduous and unpleasant work, like welding, paint shop, trim, final and body departments reported higher rates of absenteeism. However, after the industrial fallout and retrenchment of 3,500 workers, labour problems have resolved themselves. With a trimmed work force, total productivity had even increased – reports one plant which prior to retrenchment had a work force of 800 people/workers producing 60 units, but with a reduced force of 400 in 1990, reached an increased output of 70 per day!

Conclusion

The evolution of Malaysia's auto industry was very much in tandem with on-going developments of the industry at the world level. Malaysia's auto industry was initiated between 1966–69, in the form of joint ventures with European producers just when the European auto industry has reached its peak. Further down the road, when the world's auto industries faced a major crisis due to intense pressure from the Japanese beginning in the 1970s, the Malaysian auto industry also faced cataclysmic losses that had put countless lives in disarray. The crisis of the Malaysian industry was further aggravated by state induced effort at restructuring which had perforce to embrace Japanese technology and capital.

The SMA as one small player was carried along in this historical ebb and flow. And despite its fame as purveyor of hi-tech production technology and sophisticated management expertise, which were not reflected upon in its local plant, the SMA in ordinary times had been quite incapable of influencing the direction of the industry. More importantly, as its fate is shaped by

international, regional and local forces, the company must recognize the need for change on all sides and take reasonable steps to incorporate its work force to forge a stronger initiative for change. Within the local context, rank and file workers and unions have relegated the leadership role to management. They desire that management should create the environment where workers can contribute to organizational goods. But management is hesitating to transform work relationships to a less hierarchical structure, one characterized by a higher level of trust than distrust is needed to help sustain mutual commitment to success.

This is particularly urgent in view of the state push for a second national car project (600cc) with Daihatsu. The relative success of the Proton export sales, localization programme (local content is 60 percent by 1990 with 125 vendors supplying up to 80 percent of local components in 1993), and plans to assemble the car in Indonesia, Chile and Vietnam (Managing Director at AGM of Proton Vendors Association in April of 1994), will ensure the auto industry will be upgraded. Since the national auto market is too small and in view of the ASEAN complementation scheme, the larger assemblers have begun switching to becoming parts exporters. To survive these developments, existing assemblers must make good use of its resources, including its workers who are still holding back their productivity under conventional modes of hierarchial management.

References

- Bhaskar et al (1986), *Japanese Automotive Strategies: A European and US Perspective*, The Motor Industry Research Unit, Norwich, University of East Anglia
- Lee D. (1976), 'How the Malaysian Car Distribution Network Operates', *Asian Auto*, March, *Malaysian Business*, Kuala Lumpur
- Malmberg A. (1991), 'Restructuring the Swedish manufacturing industry – the case of the motor vehicle industry', in Law C. (Ed) *Restructuring the Global automobile industry*, Routledge pp 200–214, London
- Mortimer J. (Ed.) (1987), *Advanced Manufacturing in the Automotive Industry*, IFS, United Kingdom
- Odaka K. (Ed.) (1983), *The Motor Vehicle Industry in Asia*, Singapore University Press.
- Solidum E.D. and (1987), *Decision Making in an Asean Complementation Seah C.M. Scheme*, Singapore Institute of Southeast Asian Studies.
- UNIDO (1991), *Malaysia: Sustaining the Industrial Investment Momentum.*, Basil Blackwell, Oxford
- Womanck J., Jones D. and Roos D. (1990), *The Machine that changed the world*, Rawson Associates, New York
- Yearbook of Statistics (1991), Department of Statistics, Kuala Lumpur

Appendix

Worker Profile

Worker 1

Started work in 1974

Has 3 children age 9,5 and 2

Wife works in Toshiba, earns about \$1,000/m.

Workers wage about \$1,075/m.

Owns House and Car

Expenses for Car \$200+/m.

Worker 2

Has worked for 10 years

Uses motorcycle, for transportation to work from home about 10 kilometres away

Spends \$5 per day outside home (mainly at workplace)

Drinks \$1

Lunch \$2

Petrol \$2

Household expenditure: \$400–600

Wife does not work, has two children age 11 and 7 years

Worker 3

Worked in company for 5 years

Wage amounts to \$650/m.

Deducts \$300/m. for car

Rent costs \$250/m.

Wife has worked in Bata Shoe Factory for 10 years. Earns little, about \$500/m.

The origins of team work at Renault

Michel Freyssenet

In 1991, Renault decided to adopt team work throughout its European factories, in the form of Elementary Work Units (EWUs) or Unités Élémentaires de Travail (UETs), before 1994. Team work is conceived of as polyvalent and multifunctional work undertaken by a team of 20 persons. The Unit is defined by the component, mechanism or subassembly that it makes. It is led (animé) by a Unit leader, who constitutes the first hierarchical level. It controls and analyses its own production parameters. It enters into buyer-supplier relations with the other teams upon which it depends, upstream and downstream in the production process. What is expected from this form of work organization is an ability to react to problems, an improvement in the quality of products and of the functioning of machines, a greater flexibility of production, a development of competencies, an increased interest in work, and finally the modification of hierarchical relationships.

The definition of EWUs, and the decision to organize the factories according to this mode, is explicitly inspired by the Japanese experience. Yet one would not understand the specific traits and meaning of the EWUs, the conditions under which they were adopted, and the difficulties surrounding their implementation, if one was not aware of the long maturation process of the team work idea in the company, of which they are the result. This process consisted of three phases. In the first place, it has its origins in the crisis of work at the end of the 1960s, and in the experiments at Volvo. Several experiments in 'modular' work were made at this time, even though this was opposed by elements within top management. These then served as the basis for thinking about original forms of team work in the factory areas that were automated after the late 1970s. These forms owe nothing to Japanese team work, which was unknown then. The success of some of them, the need to mobilize the entirety of the personnel, and the desire to offer career opportunities to all employees, led the company to consider spreading team work to all factory areas, whether or not automated. The

Japanese example, which was becoming better known in the second half of the 1980s, then arrived to legitimate and confirm this direction. It allowed Renault's idea of team work to be enriched, without, however, causing the disappearance of those aspects born out of Renault's own experiences. The theme of the enrichment of work remained, and constitutes one of the bases upon which fundamental agreement with the unions was reached, whereas it is absent from the original Japanese idea of team work.

1. The 'crisis of work' in the 1960s and the first experiments with team work

The crisis of work first emerged at Renault in 1967, through conflicts that were often spectacular, and through growing absenteeism, high levels of turnover, and an increase in rectification work. Several types of solution to these conflicts were found, some immediate and others long term, some accepted by all and others contested.

The conflicts were ended on the basis of agreements dominated by wage payments, with no real discussion of the problems of work organization and work content which had set off the strikes. These agreements fitted in with the strategy followed by the company since 1955. The guarantee of increasing purchasing power constituted one of the foundations of the 'social contract' that Pierre Dreyfus, the second Managing Director (Président Directeur Général) of the Régie Nationale des Usines Renault concluded with the unions on 15th September 1955.¹

A second type of response, included in the multisector agreements negotiated nationally, was the reduction of working time² and the development of continuous training. This solution corresponded closely to Pierre Dreyfus' philosophy. He believed that the only compensation which could make it worth working at the assembly line or specialized machine (work which could never be different from what it was, that is to say economically superior but alienating for human beings) was the gradual reduction of working time and the development of training and learning activities, to allow employees to discover activities outside work that would permit their cultural and social development in a way that industry could never offer.

A third type of response, and the one that interests us, contradicted the view just discussed. Though supported by certain factory managers, it was not unanimously accepted by top management and was regarded with a degree of suspicion by the unions. It involved the transformation of the contents and the organization of work in 'a framework of responding to the new expectations of man at work ... a permanent requirement for the future of the company'.³

Numerous forms of work organization were experimented with by certain factory managers: rotation between two or three positions, assembly of a complete mechanism by walking it down the assembly line, lengthening the work cycle by including preparation and rectification, working on work 'islands', etc. Later, a company working group consisting of the Personnel Director and the Director of Work Study proposed: 'not only to humanize technology, but also to explore new ways of organizing the factories and the design of equipment and buildings ... [from the viewpoint] ... of the degree of freedom and of initiative that would be allowed the personnel, of the utilization of its skills, and of the possibilities of working in teams'. Several new operations resulted from this: the assembly of a complete engine at a fixed position by one worker; four short assembly lines instead of one long line at the new assembly plant at Douai; the widespread adoption at the Le Mans factory of modular assembly of front and rear axles by three to five workers, organizing themselves, responsible for the whole assembly process as well as for watching over and maintaining the equipment, taking on responsibility for quality, undertaking rectification work and ensuring the cleanliness of machines and work spaces.

These experiments in the reform of work were also of interest to certain manufacturing managers, who were concerned with the difficulties of managing an increasingly diverse and varied output. Beyond the social attractions, they saw in these forms of work the possibility of altering manufacturing schedules more easily and more cheaply.

The most radical and novel formula, that of the modules, was nevertheless a subject of controversy at the highest level. Pierre Dreyfus' Assistant Managing Director, Christian Beullac, encouraged the experiments and suggested that an evaluation on financial grounds be undertaken. However, Dreyfus himself publicly declared that he did not see industrial solutions for the future in this kind of work, which he thought harkened back to artisan work. The work study departments were openly opposed. Taking account only of the theoretical times and manpower necessary in assembly work, they easily demonstrated that modular work was not financially viable.⁴

The experiments that had been set in motion did not end, however. They inspired the forms of work organization in the automated areas which were developed when the choice was made to automate as a response to the crises of work and of productivity. One of these experiments was particularly significant, since it extended the application of the principles of modular work to machining, whereas this had previously appeared only to be applicable to assembly. A working group was established at Le Mans in 1975 to consider the possibility of introducing 'production units' into the machining areas that would be autonomous relative to upstream and downstream activities. It would be composed of various machines, grouped geographically, in which

the operators would be responsible for: running the machines, adjusting and changing tools, quality control, dealing with minor breakdowns, and maintenance. This formula was applied in three areas, though operators did not in fact undertake minor maintenance tasks or deal with minor breakdowns, and they remained under the supervision of a sub-foreman.⁵

Within this same type of solution one can classify the movement to improve working conditions and to 're-value' manual work which was supported by the government of the time. It was also a continuation of the efforts made at Renault since the start of the 1960s to take account of working conditions when designing buildings, machines, and tooling.

The work study departments of the company opposed the modular solutions and remained unconvinced of the value of expenditure on improving working conditions at work posts which, in their view, should have been eliminated as soon as possible. Their favoured solution to the crisis of work was a rapid movement towards automation that would permit the elimination of difficult and repetitive work and the development of guidance-surveillance-maintenance functions, more attractive and more skilled. This is the path that would be taken up at the end of the 1970s.

The final response to the crisis of work was brought about by the long-run slow-down in economic growth and the rise of unemployment. There was a close correlation between the reduction of manpower at Renault, beginning in 1978, and a steady fall in absenteeism and turn-over. From this point on, the development of team work during the 1980s would not have its origins directly in the crisis of work; rather, in the demands of, and the problems posed by, the shift to the automation cum integration of production. At the same time, the social necessity of enriching the content of work and of offering a career to unskilled workers would continue to be a constant and explicit theme of those who were taking the initiative of organizing team work in the automated factory areas, even though all signs of a refusal to work had disappeared.

2. The relaunch of team work in the automated areas

The installation of automated means of production in the machining, stamping, welding and painting areas, starting at the end of the 1970s, led to the relaunch of initiatives on, and further consideration of, team work, though now on a partly different basis.

The form chosen for the automation-cum-integration of machines in production lines had in effect altered the scope of work in the areas concerned. Automation consisted of a significant technological leap and of the integration in a single line of the machines necessary to manufacture a component or subassembly. It involved both simple and complex opera-

tions, partially or totally, leaving the operators to undertake tasks that were partial and heterogeneous. Regarding complex tasks, automation consisted of simplifying them and dividing them up; the repair of breakdowns especially. The machines and the production lines were equipped with automatic apparatuses that stopped them in the event of an anomaly, that located the incident in equally automatic fashion, and that involved 'standard exchange' of the failed component, fuller repairs being postponed to periods outside production.⁶

Three new problems were then posed: how to make these costly integrated lines function continuously so as to reduce their number and the period of their amortization; how to get the new mode of maintenance accepted; and how to divide up tasks, none of which occupied a person full time, and which, moreover, required different levels of competencies. These three problems raised questions about existing norms of work in the areas concerned. Production workers previously had daily quotas to fulfil, giving them relative freedom to vary the pace of work. They had tasks that were relatively homogeneous, and were easy to classify according to their level of complexity. Maintenance workers could take the time necessary for in-depth diagnosis and repair of machines. The output of a defective machine could in fact be shifted to other machines, since they were not integrated into production lines. The new scope of work in the automated areas, as it was perceived at the time, was therefore to ensure: the continuous functioning of the machines despite absent personnel and rest breaks; the undertaking of tasks at different levels by the same persons; and the rapid repair of breakdowns so that production would be disrupted as little as possible.

The organizational solutions found for these three problems varied from one factory to another, indeed from one factory area to another.⁷ They ranged from a mixed group of production and maintenance workers responsible for the entire process of running and maintaining robotized welding machines, to homogeneous groups of former unskilled workers trained to undertake, in turn, the roles of feeding in inputs, operating installations, quality control, changing tools, primary maintenance and breakdown repair on automated machining lines.

These different formulae were no longer mere experiments, but could involve whole departments of a factory: machining, welding, stamping, etc. They did not, however, represent the implementation of an official strategy by the company, but rather the fruit of local initiatives by area or department managers. Time would have to pass before top management and the totality of the management of the company would realize and understand the scope and implications of these new ways of organizing work.

Paradoxically automation also played an important role as a result of its dysfunctions. Expected to bring productivity, flexibility and quality, during

the first half of the 1980s it caused numerous stoppages of production as well as quality problems. Numerous causes lie at the root of this unreliability and the slowness in rectifying it. They include: a lack of understanding of the daily problems of production on the part of the designers, a desire to pursue technological leaps and attain large improvements in a single step, and a mode of calculating the profitability of investments which favoured manpower reductions. They are joined by: a weakness of links between the factories and the central work study department at this period, an opaqueness and needless complexity in the first machines which hindered attempts to make them reliable, and the fact that design technicians and engineers less often came up through the factories by internal promotion than were recruited directly from the major engineering colleges (Ecoles d'Ingénieurs) or were highly qualified technicians. The active participation of those actually running the machines and the maintenance workers was therefore required to analyze the problems and to find the solutions. Team work and collaboration between production and maintenance consequently appeared as self-evident.

Since 1982, it has been possible to observe four forms of team work. The differences among them are related to the individual histories of the factory, indeed the particular factory area, where they first emerged, as well as to different understandings of the problems that automation was going to pose.

The first formula appeared at the Le Mans factory, which, as we have seen, introduced modular work for the assembly of certain mechanical components, and then developed team work in its machining areas. When automated lines were put in place, the management of the factory decided to apply this form of work organization systematically. Formerly unskilled workers were trained for four months to become 'controllers' of automated machine lines. To understand the change of process and of principles in comparison to the 1970s, it is useful to review the debates that took place at the time.

At the point when automated and integrated means of production were being installed for the launch of the R9 model, the Le Mans factory sought simultaneously to 'push the skills of the operators even further', to share the 'extra amount of skill' among the whole team rather than concentrate it on an individual, to sanction this change through creation of a new personnel classification, and to gain acceptance for a new norm of production: 'to benefit from these improvements by obtaining a formalized agreement that equipment should function continuously, even though this last aspect is not related to skill'.

Management therefore proposed to create a new category of production workers who would assure, as a team, the continuous functioning (despite absences of personnel, and minimizing stoppage times) of automated ma-

chines. This would be achieved by dividing among themselves the roles of handling, loading and unloading, certain tasks that remained parcellized such as the trimming of castings, as well as the setting up and changing of tools, all the visual and physical controls, and certain maintenance tasks. Management estimated the skill coefficient of this kind of work to be 195 points, which corresponded to 'Second Level Professional', a classification which at the time did not exist in manufacturing departments, only in maintenance. Management wished to diffuse a wide technical knowledge (stamping, mechanical, assembly, casting) to the workers being promoted into this new category, so that if necessary they could be transferred from one department to another.

Discussions with the Central Personnel and Social Relations Directorate at Renault, the only body permitted to create a new classification, resulted in definitions of the competencies required and criteria for attributing the new classification. The necessary 'level of general, technical and practical knowledge' did not appear to the Directorate to have been demonstrated to the point that it would justify a classification of Second Level Professional. The Directorate feared that an overvaluation would later be challenged by those in other categories and used in their demands for reclassification.

Two solutions were discussed. Challenge would be impossible if the workers in the new category were authentically Second Level Professionals, possessing a real and recognized mechanical or electrical skill. However, it appeared to be difficult and costly to raise unskilled workers to this level of competence. It was also proposed to assign young maintenance professionals, who would have the required educational level, to the control of the automated units. Yet this seemed to present two difficulties: these professionals risked finding their work under-skilled relative to their competence and could therefore rapidly lose motivation; moreover unskilled workers would not have the chance of developing a career and would be massively affected by the reduction of manpower induced by automation.

The solution that was accepted was to recruit 'controllers' from among the unskilled workers, but to make access into this new category dependent upon: prior success in psychological-technical tests; a theoretical and practical examination following a four month period of training; an acceptance of certain working conditions (continuous working, three eight hour shifts, new tasks, team working, etc.); and upon assignment to a specified piece of equipment.

This formula for team work was therefore the result of several considerations: opportunities to a certain number of unskilled workers, the others obliged to see their posts eliminated as automation progressed;⁸ and the offer to these same workers of a professional classification, in exchange for accepting polyvalent work composed of tasks normally classified at

different levels and accepting that the production lines would function continuously.

The second formula, adopted in a robotized welding area, consisted of offering to maintenance workers (Professionals and Technicians) to become line controllers for a fixed period, and to agree to certain quality standards and a certain rate of downtime. The reversibility of this choice and the promise of more rapid promotion elicited volunteers. However, under pressure from the production manager to repair breakdowns rapidly in order to achieve production targets and to avoid hold-ups, they were not able to truly exercise their competencies in this function by organizing themselves to make full repairs and to seek the fundamental causes of breakdowns in order to eliminate them. A separate maintenance group had to be retained.

The third formula also appeared in a robotized welding area, though this time in another factory. Production workers who carried out unskilled work, but who already possessed technical diplomas, were trained full time for a year, to be able to control and repair robotized installations. Organized into groups of five persons, without a leader, they were classified as equivalent to 'Third level professionals'. It was not planned that maintenance workers would come to their aid.

The last formula was adopted in a third welding area, where maintenance, quality control and industrial engineering had been placed under the authority of the head of department. Each robotized line was controlled by a mixed production-maintenance group, consisting of a technician, a leader, an electrician-mechanic, and three operators (former unskilled production workers, classified as 'Second level professionals' following their selection and a four month training period). The division of tasks among them was not rigid, and so the operators sometimes participated in in-depth breakdown repairs, even in modifications made by the technician and the electrician-mechanic. This formula was by far the most original, and potentially the most far-reaching. It represented a good compromise between, on the one hand, the need to make repairs swiftly, and on the other hand, not postponing the search for the causes of problems and the activities necessary to make installations more reliable.

Renault discovered the wealth of initiatives that had been adopted in its various factories on the occasion of an initiative launched in 1983 by the top management, which was aimed at mobilizing all possible energies in order to deal with the deep crisis that had appeared. This initiative was called 'Industrial Restructuring and Social Dynamics' (Mutations industrielles et dynamique sociale: MIDES). In announcing it, it was said that 'the results of the firm are directly linked to its organization, to its management, to the prices and the quality of the products and services that it markets. Today, experience shows us that these parameters are mostly determined by work

relations and by the quality of life within the firm'. Management proposed to 'all those willing' and to the trade unions to participate in a joint process of analysis and reflection regarding future technological, social, economic and commercial change.

This wide debate would most notably lead to the emergence of a number of new concepts at the level of the whole firm: the basic production unit (300 persons), conceived as the basic cell of industrial activity and composed of sub-cells (8–10 persons); the idea of the 'new function of the worker'; a structure for the firm allowing rapid circulation of information; training considered as an investment; and the idea that techniques should meet the aspirations and expectations of the personnel concerning the content of work ...

The progress of this organized and round-table discussion on the problems and the future of the firm came to a halt with the 1984 financial crisis at Renault and the resignation of the Managing Director. All the same, the idea of team work, redefined on the basis of experience in the automated work areas, was beginning to convince those who were reticent about or opposed to modular work. It had become acceptable as soon as it was conceptually separated from a fundamental threat to flow-like production in the form of assembly lines or automated production lines.

3. The homogenization of different forms of team work and its diffusion beginning in the second half of the 1980s

Several factors played a role in the homogenization of different forms of team work and its diffusion. The ambitious labour force reduction goals adopted by management starting in 1985 were a first factor in favour of polyvalence, multi-functionality and team work, in as much as these allowed the elimination of substitute workers, 'setters', quality-control staff and rectification workers, as well as a significant proportion of lower-level managers.

Integrated automation, when it spread to machining, stamping, welding and painting, and when it started to be applied in assembly, was a second factor favouring diffusion. At the same time, homogenization of the various forms of team work that had emerged began. The homogeneous group of operators, former unskilled workers, taking it in turns to undertake the tasks and functions necessary for integrated production lines, became the model in the mechanical components factories. It could do this all the more easily since it revealed itself appropriate to the type of automation adopted. The simplification of tool setting, quality control, problem-spotting and rapid repair allowed these tasks to be confided to operators with only a few months training. In the robotized welding areas, the operating groups

formed only of maintenance workers disappeared, to be replaced by groups similar to those which were favoured in machining. The gap between the level of work that had to be done and the competencies of the workers was too wide. The formula of groups composed of former production workers with previous diplomas, and who were trained for a year to operate and maintain equipment, was not sufficient to obviate the need for intervention by maintenance workers. As for the most developed form, that of the mixed production-maintenance groups in the robotized welding shops, it came up against two problems. The first was the manpower reduction, brought about by the work to make the equipment more reliable that the groups had themselves undertaken. The lack of agreement with management to guarantee jobs provoked a growing reticence on the part of group members to continue their participation in these activities. At the same time, it became more difficult to undertake these activities. The pursuit of automation in the direction of automatic diagnosis for rapid repairs, coupled with the increasing opaqueness of the machines, made it still more difficult for the groups themselves to seek out and analyze the primary causes of events. Moreover, the groups were increasingly composed of operators who were formerly unskilled workers trained only to operate equipment and repair minor breakdowns.

The third factor was the adoption of a new industrial relations framework. Until 1984, Renault management had favoured the CGT trade union, which had the most members, in its relations with trade unions. With the crisis, the new management believed that this union constituted an obstacle to the resolution of the company's problems. It decided to reduce the power and influence of the union and to negotiate with other trade unions. Following a period of tension and conflict related to redundancies and the elimination of jobs from 1985 to 1987, management simultaneously sought to promote a human resources policy as a strategic choice for the firm. Round-table management-union groups met at the end of 1988. Their discussions led to negotiations regarding skills, the management of working time, the organization of work, training, and internal mobility among skilled trades. Several agreements followed: notably an accord on skills in automated areas, and above all 'the agreement for living' (L'Accord à vivre), which defined the new principles for contractual relations between the firm and its employees. 'The agreement for living' confirmed that Renault wanted to base its success in the competencies of its personnel and the relevance of its organization. A plan to give production workers new skills was created. The work team was viewed by the signatories to the various agreements as the framework for, and the means of, simultaneously advancing both the competencies of the workers and the results of the firm, including in the assembly line areas.

Automation of assembly had progressed further at Renault than at other

automobile producers,⁹ Japanese especially, but nevertheless assembly remained mostly manual. The personnel managers who had supported modular work during the 1970s (though without being able to convince others) now consider that assembly line work is unavoidable for economic reasons, the success of the Japanese serving as proof. But they believe that the assembly line has undergone profound modifications which have changed its nature. The modularization of vehicles, the possibility of off-line sub-assembly of modules, the automation of the most awkward tasks, and the introduction of more ergonomic work stations have rendered it far more acceptable. Above all, team work, which adds quality control, management, and maintenance tasks together with a relative autonomy to the long-existing polyvalency of workers at Renault, should imply the partial elimination of the awkward, parcellized, and pure-execution character of work at the assembly line.¹⁰

The fourth factor was the adoption of 'Total Quality' by management. From 1987, quality became the core of Renault's strategy. The Director of Quality became a member of the firm's board. The Renault Quality Institute was established in 1988. Its objective was to provide training in the tools, techniques, and procedures of 'Total Quality'. When the R19 model had been developed, the Director of Quality refused to sanction its launch, on the grounds that its quality was too low. This refusal came as a shock to the firm. It signified the need for profound changes in working methods and to management at all levels. As far as the factories were concerned, the participation of workers in the improvement of quality and of results required the development of an organizational form allowing them to join in this process and to be given responsibilities, as well as requiring redefinition of hierarchical relationships and of the roles of foremen. It was at this point that better knowledge of the Japanese experience led to an understanding that the work team was the organizational form that might encourage workers to participate and to take on responsibilities.

So it was that the Elementary Work Units (EWUs) became the unifying and homogenizing organizational form for the team working on assembly lines or automated production lines which had first appeared in the 1970s, giving it a precise definition and precise economic and social goals.

Unit Leaders have a hierarchical responsibility and do not work on the line themselves. They are not workers like the others, as in the Swedish group or the Japanese team. The unit is relatively large, 20 persons, though this varies. The Unit Leader therefore spends time on personnel management tasks.¹¹

In the assembly areas, the work of the team involves Taylorized tasks on moving lines. The way that operations are divided up remains the responsibility of the industrial engineering department, even if the workers are sometimes consulted; this is different from Japanese teams, which undertake

their own line balancing activities. Workers are trained to be polyvalent, and are classified as first or second level 'Production Professionals' depending upon their ability to do the various jobs on the line and to take on a few associated functions. And yet, because of short cycle times, workers are not able to fulfil these functions, except for the self-regulation which consists of declaring 'my work is completed satisfactorily'. If workers notice a problem, they call for persons to intervene, whose responsibility it is to make the problem go away. These are the unit's Technical Assistants, who are in charge of quality and tooling problems, of training for polyvalency, and of relationships with maintenance workers. The Unit Leaders are in charge of relationships with upstream and downstream production areas, following formal procedures, though they can start these off themselves. The units do not have budgetary objectives, nor their own budget. Evaluation of workers takes place annually by interview, and as necessary in cases where too many mistakes are being made. There is financial reward as a function of performance, which is calculated for the factory as a whole, within the framework of an annual agreement signed by the unions. Providing motivation is the job of the Unit Leader, via the presentation of statistics to the unit during breaks, and via teams that are formed to resolve urgent problems. Maintenance remains clearly distinct from production, so much so that it is sometimes organized into EWUs itself.

In the machining areas, in cases where machines are automated and workers do not have to load and unload components at each cycle of the machine, workers can more easily take responsibility for maintenance tasks, though these are generally limited to cleaning, oiling, and to minor repairs when machines have stopped themselves automatically. Their activities correspond better to the definition of semi-skilled production workers than do those of assembly line workers. We still see some attempts to create a new concept, that of the *exploitant*, a worker who fuses maintenance and production tasks. But these remain limited, unofficial, and are very strongly resisted.

Conclusion

Team work emerged at Renault as an attempt to reform work, but it was opposed insofar as it threatened the basic industrial principles of decomposition of work into additive operations and continuous flow of production. The enrichment of work and the development of a professional career for unskilled workers have nevertheless remained significant themes. As a result of the type of automation selected, new problems have become apparent: ensuring continuous functioning, organizing tasks which are heterogeneous and do not occupy people full time, and rapid breakdown repair. Team work was seen as permitting the introduction of these new norms of work

into the automated areas, as well as offering an enriched type of work and a career path for workers. The success of some of the organizational forms adopted, the Japanese experience, the need to mobilize the personnel to improve results, and the need to form new alliances with the unions led to the decision to spread team work to all factory areas, whether or not they are automated. In this process, the definition and the application of team work have led to the disappearance of the more audacious formulas adopted at the start of the 1980s, as much regarding the function of the team motivator [animateur] as regarding relations with maintenance.

While for Japanese automobile producers team work was and remains a means of getting employees to participate in improving productivity, quality and flexibility, rather than a means of responding to disaffection with industrial work (which is more the case today), at Renault, the theme of enriching work and offering a career path to workers remains one of the essential factors behind the choice of this form of work organization, even if other considerations and imperatives have arisen to embed it, redefine it and justify it for all.

The organizational and social dynamic which the EWUs are capable of engendering, and which some managers hope for, will nonetheless reach a limit. If it begins to threaten the basic industrial principles of additivity and linearity, and this ought to be the logical consequence of seeking the primary causes of the dysfunctionalities of sequential production,¹² then it will open up a difficult debate within the firm, just as happened in the 1970s.

Translation from the French by Sybil H. Mair.

Notes

1. Michel Freyssenet, 1979, *Division du travail et mobilisation quotidienne de la main-d'oeuvre: les cas Renault et Fiat*. CSU, Paris. 133p.
2. Between 1968 and 1977, the length of the working week was reduced from 47 hours 30 minutes to 39 hours 10 minutes for those working shifts and from 48 hours to 40 hours for the other employees.
3. Renault-inter, no. 162, 25 Juin 1973, in Michel Freyssenet, op cit, pp.165–166.
4. Christophe Midler. 1980. *L'organisation du travail et ses déterminants. Enjeux économiques et organisationnels des réformes de restructuration des tâches dans le montage automobile*. Thèse de 3ème cycle. Paris 1, pp.24–26.
5. Michel Freyssenet. 1984. *Evolution du contenu et de l'organisation du travail d'usinage*. CSU, Paris. 84p.
6. This form of automation was not the only one possible. However, its material form makes it difficult for workers or work groups to seek the fundamental causes of events or breakdowns in order to eliminate them, a formula which would be both financially worthwhile and 'skilling' (qualifiant) for the workers. Michel Freyssenet, 1992, 'Processus et formes sociales d'automatisation. Le paradigme sociologique' *Sociologie du Travail* no. 4, pp 469–496.
7. Michel Freyssenet. 1984. 'La requalification des opérateurs et la forme sociale actuelle d'automatisation' *Sociologie du Travail* no. 4, pp.422–433. On welding shops set up later than this period, Christophe Midler, Florence Charue, 1990, 'Un processus d'apprentissage à la française: la robotisation des tôleries automobile' *Colloquium: 'Organization of work and technology: implications for international competitiveness'*, Brussels, 31st May–1st June, 27p.
8. Recourse to maintenance workers to run automated lines would have required the hiring of workers in this category and an even greater and more rapid reduction in the number of unskilled production workers. The social context of this factory and the pointed problems of reclassification which that would have caused made this solution difficult.
9. The level of automation was estimated at 20 percent in 1992.
10. René Tijou, 'La chaîne de montage: maillon faible de l'industrie de grande série?' *Gérer et comprendre*. Annales des Mines, October 1991, pp. 79–82.
11. See Emmanuel Couvreur (1993). Comparaison du travail en groupe dans une usine Renault et dans une usine Volvo. *Document Renault*. 30p.
12. Michel Freyssenet, 1994, 'Volvo-Uddevalla, analyseur du fordisme et du toyotisme', *Actes du GERPISA*. Paris, March, no. 9.

References

- Benjamin Coriat (1978), 'La recomposition de la ligne de montage et son enjeu: une nouvelle 'économie' du contrôle du temps.', *Sociologie du Travail*. pp 19–31.
- Emmanuel Couvreur (1993), 'Comparaison du travail en groupe dans une usine Renault et dans une usine Volvo.', *Document Renault*. 30p.
- Michel Freyssenet (1979), *Division du travail et mobilisation quotidienne de la main-d'oeuvre: les cas Renault et Fiat*. CSU, Paris. 133p.
- (1984), *Evolution du contenu et de l'organisation du travail d'usinage*. CSU, Paris. 84p.
- (1984), 'La requalification des opérateurs et la forme sociale actuelle d'automatisation.', *Sociologie du Travail*, no. 4, pp.422–33.
- (1992), 'Processus et formes sociales d'automatisation. Le paradigme sociologique.', *Sociologie du Travail*, no. 4, pp 469–96.
- (1994), 'Volvo-Uddevalla, analyseur du fordisme et du toyotisme.', *Actes du GERPISA*. Paris, March, no. 9, pp 161–183.
- Christophe Midler (1980). *L'organisation du travail et ses déterminants. Enjeux économiques et organisationnels des réformes de restructuration des tâches dans le montage automobile*. Thèse de 3ème cycle, Paris 1, pp.24–26.
- Christophe Midler, Florence Charue (1990), 'Un processus d'apprentissage à la française: la robotisation des tôleries automobile', *Colloquium: Organization of work and technology: implications for international competitiveness*, Brussels, 31st May–1st June, 27p.
- René Tijou (1991), 'La chaîne de montage: maillon faible de l'industrie de grande série?', *Gérer et comprendre*. Annales des Mines, October, pp. 79–82.

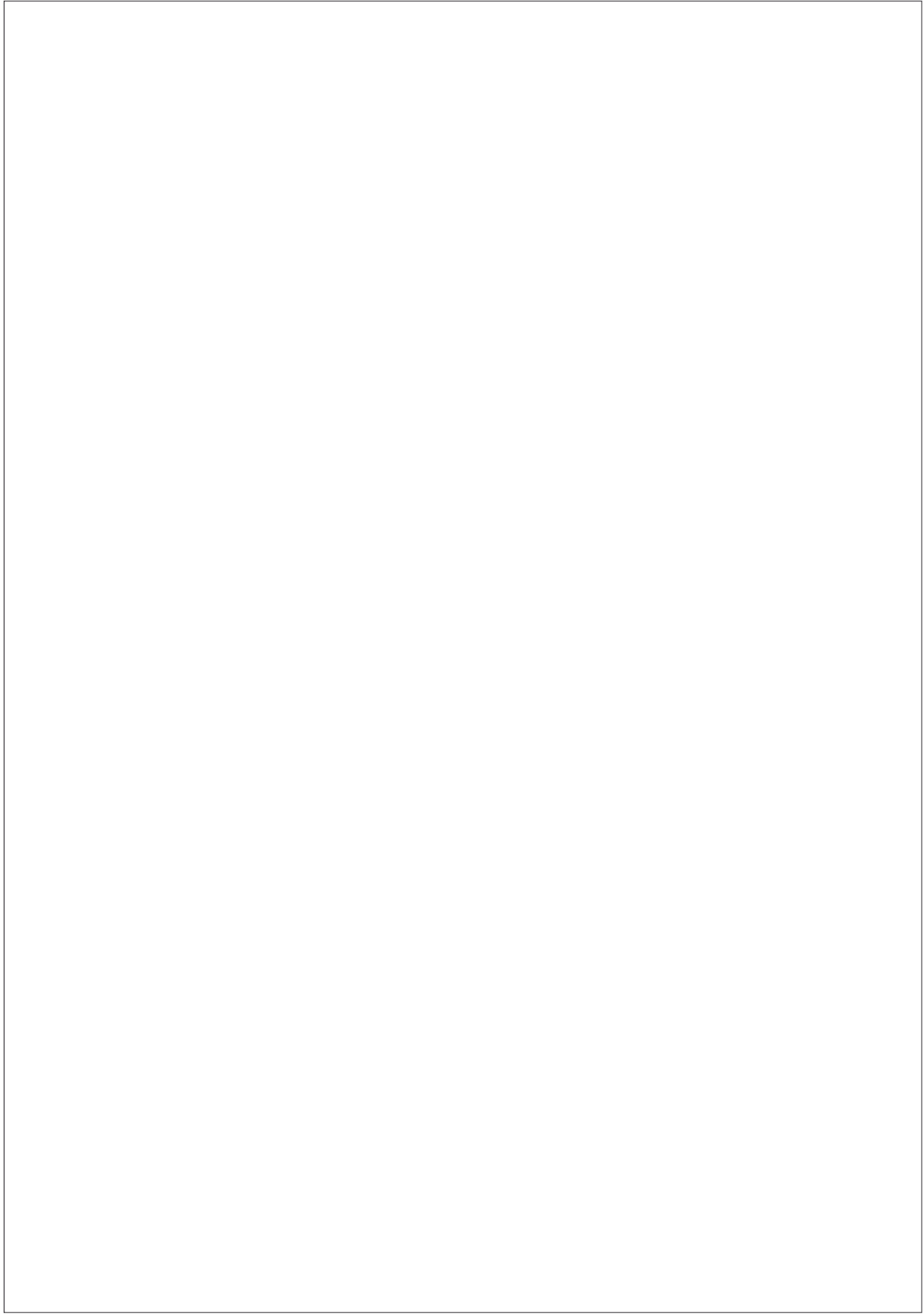

Fait accompli?

A Machiavellian interpretation of the Renault–Volvo merger

Karel Williams, Colin Haslam and Sukhdev Johal

... to maintain a balance between all the different stakeholders has ... become one of the major responsibilities of any manager or business leader in today's world ... (Pehr Gyllenhammar, *People at Work*, 1977)

... to enjoy continued good fortune, it is necessary to change with the times ... (Niccolo Machiavelli, *The Discourses*, 1531)

Preface (June 1994)

This essay is different from the others in this volume because it reprints in abridged form a public interest report which was written in late September 1993, when it appeared that the merger of Renault with Volvo's automotive interests was a *fait accompli*. The authors of the report then questioned the logic of a merger which offered Renault control and subordinated Volvo automotive in a way which safeguarded the interests of Swedish capital and threatened Swedish jobs. The report was written as a political intervention and it acted as a catalyst that helped to trigger a chain reaction; in the face of growing opposition from Volvo managers and Swedish investment funds, the merger plan was abandoned and its architect Per Gyllenhammar resigned. Since then, events have moved on apace in the company and the industry. The Volvo management has reversed the Gyllenhammar strategy of exiting autos and now promises to concentrate on its core auto business; while the BMW takeover of Rover represents the next instalment of predatory restructuring in the European cars business.

The report is nevertheless of more than historical interest because, although its positions are obsolete, its form of analysis remains relevant. The report's analysis fused two key elements: classic Machiavellian political theory and modern business analysis of cost recovery and cost reduction based on financial, market and productive data. The Machiavellian concepts

of *virtu*, *fortuna* and *occasione* were important because they undermined the orthodox business school assumption that management can master events through strategy. The distinction between cost recovery and cost reduction was complementary, because the evidence showed that Volvo's cost recovery had failed to generate the cash for new model development, just as Renault's cost reduction had not created a robust company which could weather cyclical downturn. With or without the merger, further restructuring was therefore a cruel but necessary process in which the interests of worker stakeholders would be sacrificed.

Temporary good fortune has postponed the day of reckoning for Swedish workers. Volvo Car's profits have staged a cyclical recovery as the sales success of the 850 loads the Swedish factories and a weak krona boosts the profitability of export sales. But the fundamentals analysed in this report have not changed and will reassert themselves when fortune changes. Volvo remains a small car company whose problems about financing new model development require more joint venture deals like the one with Mitsubishi which allows replacement of the 400 series. The Swedish social settlement makes Sweden an inherently high cost base for car production in a business which is rapidly going global. When fortune does change, Volvo's workers cannot rely a second time on the investment funds and Volvo managers for whom opposition to the Renault merger was a way of unseating Gyllenhammar. In the lull before the next crisis, Swedish workers should therefore look to their trade unions and Swedish politicians should look to the European Union, which is the only institution that can put a floor under destructive social competition between social settlements.

If this preface summarises our position as of June 1994, the text which follows reprints our original report of September 1993 with only a few changes of tense and some minor cuts which were made to reduce length.

Introduction

Although the merger of Renault and Volvo's automotive interests was subject to Swedish shareholder approval, when the two companies announced their plan in September 1993 they effectively presented the merger as a fait accompli. The French reaction was quietly triumphalist. Gerard Longuet, the French Minister of Industry claimed the merger was 'an industrial event that comes once a decade' (*Guardian*, 7 September 1993). Swedish reaction was more muted. Prime Minister Bildt, like the opposition Social Democrats, welcomed the merger as a development which would secure the future of motor manufacturing in Sweden. A Swedish investment banker observed that Volvo's loss of independence was 'regrettable but inevitable' (*Financial Times*, 7th September 1994). Outside France and Sweden media

commentators struggled to find an interpretation which would make sense of the merger. All agreed it was a result of the car wars which were making it increasingly difficult for struggling companies to make profits in an industry whose excess capacity feeds saturated and cyclical markets.

This report presents a hard interpretation argued within a Machiavellian framework, where the proposed merger is an opportunity (*occasione*) for two firms buffeted by fortune (*fortuna*) and lacking the ability (*virtu*) to master events in the cars business. It is an opportunity for both parties because their calculations are different: it strengthens Renault's productionist commitment to its core business, while for Volvo the merger represents a further stage in the company's metamorphosis into a diversified holding company driven by the imperatives of financial engineering. The irony of this development will not be lost in Sweden where Swedish capital once presented itself as the humane steward of the interests of the worker stakeholder, and Volvo figured as a model for the future of work. Through merger Swedish capital would privilege its own interests and break its obligations to the workforce while Volvo becomes a post-industrial firm just like the Anglo American conglomerates.

We argue this case in two sections which separately address the key questions: why does the merger subordinate Volvo and what would happen after the merger?

1. What determines the form of the merger?

The first essential feature of the merger plan is that Volvo will be subordinated as the junior partner. Renault will have a 65 per cent stake in the new combine against Volvo's 35 per cent. Louis Schweitzer of Renault becomes chief executive of the combine whose headquarters will be at Boulogne Billancourt. Volvo has obtained no guarantees on the maintenance or location of development, investment or production of major product lines. The second essential feature of the merger is that Renault will get the Volvo cars and trucks business through share exchange without paying any cash for them. Renault is doing much better than Ford and GM did when earlier in the cycle in 1989 they bought into Jaguar and Saab. Ford paid £1.56 billion when it bought out Jaguar's shareholders. In the Saab deal, the Wallenbergs held back Scania trucks and offered GM a 50 per cent joint venture but on condition that GM injected \$100 million, assumed responsibility for part of Saab's debt of SEK 3 billion (£300 million), and provided new product (*Financial Times*, 16 December 1989).

Why is Volvo subordinated and how is Renault able to buy into Volvo without paying anything in cash? The answer is that in the period 1990-2, when the basis for the present merger was being established, Renault was

relatively strong and Volvo was relatively weak. In March 1993 Renault's announced 1992 profits which had doubled to FF 5.7 bill.; in dramatic contrast Volvo AB returned record losses of SEK 4.75 billion (*Financial Times*, 12 March 1993). Against this background, a Machiavellian logic determined the outcome because Volvo Group, the car and truck division of Volvo AB, was a weak company caught in a series of adverse power relations which delivered it into the hands of Renault.

For the MIT team that wrote *The Machine that Changed the World* (Womack et al. 1990), Volvo figures as an example of inefficient 'neo-craft production'. The book promotes the concept of lean production and explicitly singles out the Uddevalla plant for criticism. Back of envelope arithmetic is used to set up a vague (and irrelevant) hours to build comparison between the Uddevalla luxury car plant and Toyota Takaoka which produces the Corolla at 40 times the volume (Womack, 1991, pp. 100-3). Much the same line is taken in Adler and Cole's (1993) Sloan Review article which makes another apples and pears comparison between Udevalla and the American NUMMI plant, a Toyota/GM joint venture. The condescension of posterity is already being brought to bear on Volvo's two experiments in assembly without lines; in *Personnel Management* (May 1992), these experiments were dismissed (without evidence) as attempts to control absenteeism and labour turnover 'with little regard to the effect on production, costs and efficiency'.

The 'humanisation of work' has gone out of fashion just like modernist architecture. It is therefore important to make two points about Kalmar and Uddevalla. First and generally, assembly plant efficiency and inefficiency is not very important in the cars business because, as Womack admits, final assembly accounts on average for just 15% of the labour hours in a finished car. Second and more specifically, Kalmar and Uddevalla are not being closed because they are inefficient but because they are branch plants which are surplus to requirements in a firm which is producing at no more than two thirds of capacity. They are both low volume plants which have together produced less than 40,000 cars in recent years; the famous plant at Kalmar employs just 800 workers. Like any other retreating company, Volvo is closing branch plants so as to load the throughput down the lines of its central plant at Torslanda' where less than 75,000 cars were made in 1992 when it operated at less than half-capacity.

Against this background it is important to insist that Volvo is, in efficiency terms, an average firm whose record is no better and no worse than that of other European producers of specialist and luxury motor cars. All these firms through the 1980s pursued the same basic strategy of cost recovery (rather than cost reduction); the aim was to maintain or reposition their products in the upper middle market segments so that existing costs could be recovered. As a comparison with BMW shows (Tables 1 and 2), none of the

European players in this game managed high levels or sustained increases in productivity. BMW is the obvious point of reference, as the most closely comparable European specialist producer which is also widely believed to perform better than other specialists.

Table 1: Volvo car productivity

<i>Year</i>	<i>Output</i>	<i>Employees</i>	<i>Cars per employee</i>	<i>Span adjusted cpe</i>
1981	289,700	25,400	11.41	2.9
1982	317,000	27,950	11.34	3.4
1983	365,000	28,700	12.72	4.4
1984	387,000	31,000	12.48	4.6
1985	392,700	32,250	12.18	4.4
1986	419,500	32,850	12.77	4.5
1987	418,600	34,050	12.29	3.9
1988	400,900	34,100	11.76	3.4
1989	405,600	34,750	11.67	2.9
1990	359,600	33,550	10.72	2.8
1991	309,300	30,400	10.17	2.7
1992	303,800	28,453	10.68	2.2

Source: Volvo, *Annual Report and Accounts*, various years

Note: Process span adjustment is obtained by deflating cars per employee using the value added/sales ratio as a proxy for process span.

Using the simple and intelligible cars per employee measure, Volvo's 10–13 cars per employee is better than that of BMW in every year since 1981. Even after adjusting for differences in the amount of each car built in-house by the two companies, Volvo performs better in seven of the eleven years between 1981 and 1991 and is more or less equal in three more; BMW only pulls ahead in years like 1981 and 1992 when Volvo's output is cyclically depressed. In retrospect Volvo car management made a major mistake in hiring 8,500 extra workers in the upswing between 1981 and 1987, and as a result never managed better than 12.77 cars per employee at the peak in 1986. But the broader record of Volvo Group does not suggest that this is an organisation which is unable to manage auto factories: the trucks division managed a 50 per cent increase in labour productivity over the 1980s.

Volvo's misfortune was not productive incompetence, but limited space in the mid- market niches where Volvo traditionally sold its product, and where its sales are now increasingly blocked by better resourced German and Japanese competitors. These larger competitors can improve their

Table 2: BMW car productivity

<i>Year</i>	<i>Output</i>	<i>Employees</i>	<i>Cars per employee</i>	<i>Span adjusted cpe</i>
1981	351,545	39,777	8.8	3.4
1982	378,769	40,738	9.3	3.5
1983	420,994	43,169	9.8	3.6
1984	431,995	44,692	9.7	3.5
1985	445,223	46,814	9.4	3.2
1986	446,438	50,719	8.8	3.1
1987	461,340	54,861	8.4	2.8
1988	484,120	56,981	8.5	2.7
1989	511,476	57,087	8.9	2.8
1990	519,660	59,544	8.6	2.8
1991	553,230	61,617	9.1	2.6

Source: BMW, *Report and Accounts*, various years

Note: Process span adjustment is obtained by deflating the cars per employee by the value added to sales ratio as a proxy for process span.

product ranges faster than Volvo which had to persevere with out-moded products like the old 300 and 200 series. In the late 1970s Volvo's German competitors consolidated their dominant position in the only two national markets, Germany and the USA, which are large and affluent enough to support volume sales of luxury cars. Between 1974 and 1988 German luxury car output increased by 20 per cent and real sales turnover by 114 per cent (Auer, 1990) as VW moved its product up market while Benz and BMW found volume in the middle of the market. By the late 1980s, Volvo like all the non-German European specialists was caught between a rock and a hard place in the US market, as the Japanese moved up market with luxury ranges like Lexus and Infiniti which sold on price against the dominant German product. The Japanese effectively blocked any attempt to sell the 400 in the United States and will make it increasingly difficult to charge premium prices for large Volvos.

In Volvo's case the general problems about market space were compounded by a narrow market spread. Volvo's volume sales are concentrated in just three national markets (Table 3). Again the contrast with BMW is instructive because BMW builds strength with a strong specialist position in its large home market and a two per cent plus share of every other European car market. Volvo has only a small home market, whilst the UK and USA were the only export markets where the company succeeded in selling more than 50,000 cars a year at the height of the 1980s boom. Together with Sweden these markets accounted for 50-60 per cent of sales in the 1980s.

The company has lost market share in each of them; the fall in the United States is particularly threatening since around one quarter of Volvo cars output was sold there in the 1980s.

Table 3: Volvo car registrations (1000's units) by market

<i>Year</i>	<i>Sweden</i>	<i>USA</i>	<i>UK</i>	<i>France</i>	<i>Germany</i>	<i>Italy</i>	<i>Other</i>
1981	49.9	67.5	44.5	9.2	13.9	15.6	89.1
1982	57.3	69.7	51.3	10.3	12.9	15.1	100.4
1983	62.1	91.8	60.9	14.1	14.6	21.1	100.4
1984	62.4	93.4	59.5	15.8	14.4	21.1	120.4
1985	71.2	109.8	60.5	17.7	14.3	17.5	101.8
1986	64.5	114.3	69.6	19.1	14.3	16.4	121.3
1987	72.4	101.8	70.5	18.9	17.5	15.8	121.7
1988	74.6	94.9	79.8	17.7	16.8	15.3	101.8
1989	66.6	97.8	82.8	15.9	17.0	14.2	111.3
1990	47.6	93.0	66.3	11.5	18.4	23.5	99.3
1991	37.8	65.3	46.1	8.1	20.6	21.1	110.2

Source: Volvo, Report and Accounts, various years

If Volvo's market spread was too narrow, its model range was too broad for the strategy of cost recovery. Volvo is a relatively small car company making just 420,000 cars at the cyclical peak in 1986 and only 304,000 in 1992. Such companies have characteristic problems about cost recovery, because they have to recover the expense of developing the next generation of models over relatively short production runs and therefore need to generate a large amount of cash per vehicle sold. In Volvo's case, this problem is aggravated by the way in which Volvo's output is spread over the medium, large and luxury classes: the 1992 output of 304,000 consisted of three entirely different models, the 400, 850 and 900, which effectively do not share major mechanicals. The contrast with BMW is particularly telling: BMW is basically a two model firm where the 3 and 5 share major mechanicals, and the volume selling 3 alone generates sales of 300,000 each year. The typical Volvo model sells closer to 100,000, insufficient to generate enough free cash from each car sold to cover the cost of replacement every seven or eight years. Volvo Cars's most recently developed model is the 850 which, including an all new power train factory, cost SEK 16.5 billion (*Financial Times*, 23 May 1991). Even if the 850's successors could be developed more cheaply, the basic point remains: the arithmetic of cost recovery does not add up for Volvo.

Table 4: Volvo car value added, labour share and cash flow

<i>Year</i>	<i>Sales revenue SEK million</i>	<i>Net income as % of sales</i>	<i>Value added SEK million.</i>	<i>Labour costs SEK million</i>	<i>Labour as % of value added</i>	<i>Cash flow per car SEK</i>
1981	13,569	1.5	3,532	2,519	71.3	2,280
1982	18,109	2.4	5,490	3,371	61.4	6,684
1983	26,262	4.8	9,210	3,960	43.0	14,383
1984	30,304	6.6	11,119	4,831	43.5	16,232
1985	33,956	7.1	12,389	5,476	44.2	17,604
1986	35,956	6.6	12,649	5,844	46.2	16,224
1987	38,523	4.7	12,093	6,376	52.7	13,664
1988	39,462	3.7	11,542	6,695	58.0	12,092
1989	42,944	2.1	10,856	7,452	68.6	8,396
1990	39,433	(1.0)	9,595	8,713	90.8	2,455
1991	36,079	(2.2)	8,104	8,442	104.2	(1,092)
1992	44,598	(2.2)	7,517	7,906	105.2	(1,280)

Source: Volvo, Annual Report and Accounts

Notes:

- (1) Labour cost and depreciation figures are imputed on the basis of the car operation's share of employment and capital investment in Volvo Group (ie Volvo's automotive division).
- (2) Value added is obtained additively as the sum of labour costs and depreciation and net income.
- (3) Cash flow is calculated by adding net income and depreciation.

The precarious fundamentals of the Volvo cars business were disguised for much of the 1980s because, like any weak car company, Volvo looked good on the cyclical upswing. Like Jaguar and Saab, Volvo made money as long as the American market boomed and the dollar exchange rate was favourable; in the boom years of 1983-6 Volvo got SEK 7-8.5 to the dollar on its American sales compared with 5-6 in most other years (*International Financial Statistics Year Book*, 1992). On the downswing, fundamentals reasserted themselves and financial results became quite dire. The imputed values given in table 4 are, in our view, accurate enough to illuminate the transition from feast to famine.

From 1983 to 1987, Volvo car managed a return on sales of 5-7 per cent. Labour's share of value added was in the range of 45-55 per cent and, if we define cash flow as sales minus labour costs, the company gushed cash; in a good year like 1985, the company had a cash flow per unit of SEK 17,600 (\$ 2,060). In this exceptional period model replacement was not a

problem; the cash of the boom years covered the development expense of the 400 and 850 models. But as boom turned to slump the cars business made losses. Labour's share of value added always increases in car companies as sales fall, and in weak Volvo the increase was disastrous: in 1991 and 1992 labour costs accounted for more than 100 per cent of the value added fund, leaving nothing over for depreciation, or any form of new investment in plant, tooling and development. Shedding labour, market recovery and improved exchange rates could probably restore labour's share to the normal manufacturing level of 70 per cent, but that would be insufficient. This kind of normal share in years like 1981 or 1989 had yielded a cash flow of SEK 3-8,000 which was inadequate to cover replacement expenditure. To cover development costs Volvo Car needed a labour share closer to 50 per cent and that was out of reach.

Volvo Car's operating position could be righted but, given its inability to generate the cash for model replacement, the business was not self supporting; it needed a cash cross subsidy from elsewhere. But corporate reorganisation at the end of the 1980s had changed the relation between Volvo Group, of which cars was a part, and Volvo AB, the quoted parent company in which the public holds shares. By 1990, with divestment and corporate reorganisation, less than 15 per cent of Volvo Group's sales revenue was in non-auto activity: Volvo Group was effectively reduced to an automotive rump of cars and commercial vehicles which were affected by the same downturn as cars, so any cash cross-subsidy for cars would have to come from Volvo AB. After 1989, Volvo AB effectively functioned as a financial holding company with majority and minority stakes in a diverse range of businesses including oil, property, foodstuffs and pharmaceuticals as well as autos; 86 per cent of Volvo AB's total assets currently consist of investments in shares. Volvo AB did not have a strong cash flow because it was simply a financial intermediary: all or more of the cash received as dividends from the subsidiaries and associates of Volvo AB was paid out as dividends to the shareholders of Volvo AB.

Whether by accident or design, Volvo's corporate structure made cross-subsidy very difficult and that left Volvo with the one option of selling a business which was not self-supporting. It was, from the beginning, a distress sale and Renault took full advantage of this fact. Thus the original share exchange of 1991 was not simply a paper for paper exchange but involved a large balancing cash adjustment payment from Volvo to Renault. According to the 1991 Volvo accounts (p. 41) the cash payment from Volvo to Renault was FF 5,887 million; thus Renault got an 'engagement present' of roughly £500 million in cash, a sum which would go a long way to covering the replacement cost of any model in the Volvo or Renault range. When the full merger was announced in September 1993, Renault got its dowry not

in cash but in the form of the balance of the Volvo heavy trucks business. This was a potentially stand alone business which was really worth having because it had a strong market position and a new heavy truck product line, whose development cost had been paid for so that it was not necessary to think about replacement investment for another decade.

If this seemed over-generous to Renault, the fact was that Volvo AB, as a distress seller, had no bargaining position because it could not walk away from the only buyer. At the same time Volvo hoped to win a risky longer term financial game, which will be analyzed more fully in the second section of this report. Through merger Volvo AB would swap a majority stake in its car and truck businesses for a minority stake in Renault Volvo. In financial terms, this would get Volvo off the hook of sole responsibility for its cash hungry auto business and leave it with a claim on anything which Renault might distribute to its shareholders. From a financial engineering point of view, there was also the prospect that, after privatisation, the Renault paper would be tradeable and Volvo AB would in this case have a variety of exit options.

Table 5, Sales price per unit (in FF) for various car companies

<i>Year</i>	<i>Renault</i>	<i>VW</i>	<i>Ford (UK)</i>	<i>BMW</i>
1990	53,478	91,581	90,708	146,985
1991	53,283	79,307	95,105	143,507

Source: Renault, Company Report and Accounts (cars division)

Renault's emergence first as Volvo's ally, and then as senior partner in the merged combine, surprised many social scientists who tend to confuse the companies with their products. Renault's cheap and cheerful small cars may lack the quality of the solid and dependable Volvo product but as a company Renault is much stronger. Of course, Renault's concentration on small cheap motor cars raised problems. For example, Renault's sales price per unit is no more than two thirds of that realised by VW or Ford (UK) and not much better than one third of BMW's selling price. To this extent, like other South European producers of small cars, Renault was trapped downmarket. To combat this Renault embarked on a strategy of cost reduction, taking out assembly labour hours and costs and pressing its suppliers to do the same.

Renault's renaissance of the early 1990s owes everything to the aggression and intelligence with which it pursued these objectives. Renault claims a 50 per cent improvement in labour productivity between 1985 and 1991 (Financial Times, 6 October 1991) and this claim is corroborated by table 6 which shows how Renault built the same number of cars with an ever decreasing workforce.

Table 6, Renault cars division vehicles per employee

<i>Year</i>	<i>Cars</i>	<i>Employees</i>	<i>Cars per employee</i>
1987	1,831,400	136,646	13.4
1988	1,850,700	131,964	14.0
1989	1,966,700	129,699	15.2
1990	1,766,700	114,516	15.5
1991	1,790,700	106,223	16.8

Source: Renault, *Annual Report and Accounts*, various years

The best efforts of car firms to reduce hours are regularly frustrated by market difficulties and cyclical declines in sales. Renault postponed this problem because the aggression it put into hours reduction was matched by the intelligence of its marketing effort, which ensured that its factories were steadily loaded with throughput. Besides being market leader in France with a steady 30 per cent share of a 2 million per year home market, Renault currently holds more than 5 per cent of every other European national market, including the UK. A significant indicator was its 5.4 per cent share of the German market in 1991 which made it that country's leading importer.

Nonetheless all this effort had disappointing financial results. The causes and consequences of Renault's poor financial performance will be analysed in section two; for the moment, all we need observe is that net income as a per cent of sales reached the respectable level of 5 per cent for only two years in 1988 and 1989 before collapsing to 0.7 per cent in 1990 and then rebounding to 3.2 per cent in 1992. But, after 1986, Renault did succeed in putting six consecutive years of losses behind it, including the record 1984 loss of FF 12.6 bill. Renault's managers were therefore free to consider the purchase of another car company provided the owners of that company did not want cash.

Table 7, Renault European sales and market share

<i>Year</i>	<i>EC total market 1000s units</i>	<i>French market share %</i>	<i>German market share %</i>	<i>EC market share %</i>
1987	2,475	32.2	3.1	11.5
1988	2,594	30.9	2.9	11.1
1989	2,668	31.1	3.5	11.3
1990	2,703	29.9	3.5	10.8
1991	2,377	29.1	3.5	10.7

Source: Renault, *Annual Report and Accounts*, various years.

The arguments for buying Volvo were productionist. The European volume cars business was, by general consent, ripe for rationalisation. None of the volume manufacturers could avoid losses in the cyclical downturns and the problem of excess capacity would be aggravated by increasing Japanese imports and transplant production. The European volume car business was also highly fragmented with twelve companies competing against each other. Against this background, any increase in size which did not weaken Renault financially was likely to improve Renault's chances of survival. Furthermore, the Volvo brand name was recognised worldwide and had a unique reputation for safety and durability. Business school academics may debate the value of brands but they remain important in cars because consumers around the world are reluctant to buy large expensive cars which carry the badges of mass market car companies; Renault's recently launched large car, the Safrane, is currently failing in the market place despite being advertised across Europe. This is the reality which Volkswagen recognises by developing the Audi brand and which the Japanese recognise by selling their luxury cars badged as Lexus, Infiniti and Accura.

It was initially hard to see how cash hungry Volvo Car could do anything but drain Renault's financial resources. But, discussions about a common large car platform (codename P4) and shared mechanicals showed that, on this basis, Volvo's requirement for development expenditure could be more or less halved and that Renault needed to spend little more than it would have had to do as an unsuccessful maker of large mass market cars. As long as Volvo car stood alone, its owners would need an impossibly low 50 per cent labour share of value added to cover replacement, but Renault could make a go of the same business on a shared development basis with a labour share of 70 per cent. There was a downside financial risk because the market for cars was saturated and unpredictably cyclical. But there was no risk of French loss of control through hostile takeover since Renault was currently nationalised and, even after privatisation, the French government intended to take a 'golden share' which would protect Renault management.

2. Where would Renault and Volvo go from here?

If the form of the merger had been determined by Volvo's relative weakness and Renault's apparent strength, by the time the merger was announced in September 1993 the relative position of the two companies had changed. In the previous month Volvo and Renault had announced their provisional results for the first half of 1993. Volvo 'confounded market expectations' when, instead of anticipated losses of SEK 500 million, Volvo AB reported a return to operating profit and an overall surplus of SEK 166 million (\$20.5 million) (*Financial Times*, 27 August 1993). Renault announced an 87 per

cent year on year drop in pre-tax profits to FF 730 million (\$123.93 million) (*Financial Times*, 27 August 1993).

Volvo's return to profit did not reflect any change in the productive fundamentals of its auto business: the 13,000 or 19 per cent reduction in the workforce since 1990 had been matched by a 15 per cent fall in sales. The miraculous recovery owed more to good luck and creative accounting. Volvo Group was benefiting from a temporary pause in replacement expenditure because the company had just completed development of a new heavy truck. A 25 per cent currency devaluation also brought a windfall gain of some SEK 200 million (*Financial Times*, 27 August 1993). And the decision to capitalise tooling costs brought a gain of SEK 400 million (*Ibid.*). As for Renault, that had suffered a real profits collapse which exposed its weakness; whatever the French managers had done, they had not created a robust company which was capable of withstanding the inevitable cyclical downturns. The underlying reason is relatively straightforward: Renault had taken labour hours out of its product over the 1980s but so had all its European competitors in the small cars business (Table 8).

The German industry represents the strategy of cost recovery and never manages much above a 10 per cent improvement on 1981 productivity levels. German success in the middle and top end of the market forces all the other producers into making smaller cheaper cars and these companies have no option but cost reduction through taking labour hours out. Unlike Germany (and Sweden), the other European countries all manage substantial productivity gains, at least in the upswing. The French industry pulled the hours reduction trick but the Italian and Spanish industries, which also specialise in small cars, did even better. From Renault's point of view as the major player in the French industry, and a minor player in the Spanish industry, the problem was that it had worked miracles but had not obtained any competitive advantage.

Table 8, Motor vehicles per employee (percent change on 1981)

<i>Year</i>	<i>Germany</i>	<i>Spain</i>	<i>France</i>	<i>Italy</i>	<i>UK</i>
1981	0.00	0.00	0.00	0.00	0.00
1982	4.86	23.49	7.90	5.00	10.16
1983	5.88	25.81	13.07	19.26	25.37
1984	1.62	28.13	8.92	25.38	18.04
1985	8.71	35.38	13.54	29.56	32.14
1986	9.52	40.71	23.51	42.27	32.71
1987	8.89	44.67	32.15	44.88	40.11
1988	9.25	49.69	37.08	49.14	44.47
1989	12.76	52.35	41.82	50.55	46.99

Source: Eurostat

Because Renault had no competitive advantage, its financial results were always mediocre. This point emerges very clearly from any analysis of the financial ratios in the (non consolidated) accounts of Regie Nationale which is Renault's core operating business; the Regie accounts for nearly 70 per cent of total Renault sales and car sales account for around 75 per cent of the Regie's turnover.

Table 9 covers the period when the financial benefits of productivity reduction should have been coming through. But, as a seller of small cheap cars, even in the two best years, 1988 and 1989, Renault did no better than realise FF 5,200 (about £500) per vehicle sold; in its heyday in the mid 1980s Volvo could realise three times as much. 'Small car, small profit' was an industry adage of the 1960s; twenty years later Renault's cash recovery still depended on its ability to shift large numbers of small cars. Worse still, Renault was conceding nominal wage increases in the late 1980s so that the financial benefits of head count reduction were very modest. Thus, only in two years, 1988 and 1989, did Renault succeed in getting labour's share of value added below 70 per cent; the very modest fall in the Regie's output after 1989 bounced the labour share back up above 70 per cent. This kind of variation suggests, and 1993 confirms, that a further output reduction of around 10–15 per cent would create real problems. In the mature cyclical car markets of Western Europe, peak to trough demand falls of 20 percent plus are the norm: thus Renault had not created a robust firm because it never achieved the financial ratios which would allow the firm to ride out an average European downturn.

Table 9: Regie Renault value added, labour's share and cash flow

<i>Year</i>	<i>Income pre tax and deprctn FF million</i>	<i>Employ-ment costs</i>	<i>Value added</i>	<i>Labour share of VA</i>	<i>Units 1000s of vehicles</i>	<i>Cashflow per unit FF</i>
1987	3,620	14,165	17,785	79.65	1,831	1,977
1988	8,201	13,850	22,051	62.81	1,851	4,431
1989	10,166	14,287	24,453	58.43	1,967	5,169
1990	4,745	14,331	19,076	75.13	1,777	2,671
1991	5,768	14,527	20,295	71.58	1,791	3,221

Source: Renault, *Report and Accounts*, various years

Notes:

- (1) Value added is obtained additively by by summing labour costs and depreciation and net income.
- (2) Cash flow is calculated by adding net income and depreciation.
- (3) Labour costs include wages and salaries.

By autumn 1993 Renault was in the middle of an average downturn; in the first eight months of 1993 the EC car market was 13 per cent down on the previous year. Renault's output in the first six months of 1993 was 19 per cent down on the comparable period in 1992; we estimate that if this sales loss is sustained, labour's share of value added will rise to 90 per cent in the Renault group and cash flow will be halved. Although Renault, hovering around break even in the first half of 1993, was performing better than loss making competitors like VW, Ford of Europe or Fiat, the newly elected centre right French government has scheduled Renault for early privatisation which requires a track record of profits rather than the avoidance of loss. Renault is the most political of European car companies and knows it must please its new political masters by finding profit and, *inter alia*' the quest for profit means turning the newly acquired brand into a winning business. The company that plans to take over Volvo auto is not a strong company but a desperate company.

At the press conference which launched the merger, it was claimed that the combined automotive operations could make savings of FF 30 billion (£3.4 billion) before the year 2000 as a result of rationalisation and integration of overlapping activities. No doubt this figure was plucked from the air but it did express a truth because across large areas of their activity the merged companies have duplicate development teams, product lines, assembly facilities and supplier networks. By substituting one for two of everything, large savings could be made within seven years or so which is roughly equal to one product life cycle. The crucial question is whose development teams, product lines, assembly factories and supplier networks would bear the brunt of the adjustment.

Table 10: Hourly labour costs in Sweden and France (in SEK)

<i>Year</i>	<i>France</i>	<i>Sweden</i>
1980	45.8	66.6
1983	69.7	83.6
1986	74.6	113.7
1989	83.9	143.7
1991	96.5	169.4

Source: VDA

Volvo's Swedish workers and the 10,000 employed by Volvo's Swedish suppliers have reason to be fearful because the Swedish social settlement makes Sweden an unattractive high cost location for auto production. Swedish workers in Volvo and its supplier factories receive high wages and work short hours. Table 10 presents basic data on motor industry employment

costs per hour in France and Sweden taken from the standard German VDA source. French hourly employment costs are broadly comparable with those paid in Italy or Britain but Swedish employment costs, in recent years, have been about 45 per cent higher.

If the Swedish social settlement imposes a large mark up for social welfare benefits, the burden of social charges is increased by the very short hours which are typically worked in the Swedish auto industry. Short hours mean more workers and more per capita social charges to deliver a given quantum of assembly or supplier factory labour. This problem arises one not because the standard working week is very short in Sweden but because the social welfare system offers an assortment of leave arrangements for responsibilities such as parenting which are less provided for in other advanced capitalist countries. According to Riegler and Auer (1991, p. 234) Swedish blue collar workers in car and engine production actually worked an average of less than 1450 hours per year in the period from 1981 to 1986. Renault's workers in France and Spain are on a standard year of around 1800 hours and most of those hours are actually worked.

The sale of Volvo's automotive interests would thus presage a post modern attack on the Swedish social settlement. As a trans-national, Renault Volvo automotive would not need to demand wage cuts, provoke strikes and tough it out with the Swedish workforce; the combine could simply transfer its supply contracts and assembly work to other advanced countries with less generous social settlements, while Swedish workers go quietly into the dole queue which already includes 13 per cent of the workforce. One informed estimate by Kurt Syren of Gothenberg University predicts 10,000 job losses at Volvo and supplier factories within three years (*Guardian*, 7 September 1993). Those who think this is alarmist should remember that since Jaguar was taken over by Ford employment has been more or less halved from 11,700 at the end of 1990 to 6,500 at the end of 1992 (*Financial Times*, 28 September 1993).

If the merger goes through, the job losses will not be a problem for Volvo AB's managers who will have passed the auto business on so that it becomes Renault's operating responsibility. At Volvo AB they will face the new and different problems of running a diversified investment trust; the sale of Volvo's automotive interests to Renault in return for a paper claim on the earnings of the combine would complete Volvo's transformation into a rentier holding company.

The sale of the Volvo auto business is a financial exercise in protecting the interests of Swedish capital. Volvo AB managers who planned the sale are imitating Lord Hanson and Jimmy Goldsmith, whose alchemy turns illiquid and low yielding capital assets into cash for reinvestment in assets offering higher yields or capital gains. The merger would successfully

complete the first phase of this transformation. Before Renault came along Volvo had large amounts of capital tied up in auto factory assets that nobody wanted to buy for cash; worse still, the auto business offered no prospect of decent returns and was cash hungry. If the merger is completed, Volvo will have turned its assets into paper which gives it a shareholder's claim on Renault's earnings when Renault makes a profit without any downside risk because Volvo has no responsibility for Renault's operating losses or cash requirement. The Renault paper which Volvo AB then holds may not of course offer a decent rate of return but, when or if Renault is privatised, the paper becomes tradeable. That opens up the prospect of a second phase of transformation whereby Volvo gets back to cash by selling its paper. On 28 September company sources confirmed that, after the merger, Volvo AB would be free to sell all its holdings in Renault subject only to the condition that it did not sell the stake to a competitor of Renault.

Such a sale is made likely because Volvo AB's financial portfolio includes too many low yielding problem investments. By 1994 its main interests will include its 35 per cent stake in Renault Volvo; 25–35 per cent of Pharmacia, the pharmaceuticals business of Procordia; a 100 per cent share of Branded Consumer Products, the consumer goods business of Pharmacia; and a rag bag of investments mainly in property and oil. The cash cows are Pharmacia and BCP both of which have a starry return on sales of 10 per cent. The problem investments include everything else because Renault Volvo will never generate half that return on sales and Volvo's non-auto investments have generally performed badly. Volvo's oil trading and investment subsidiary Beijerinvest, for example, cost it money for most of the 1980s and Beijerinvest was in many ways the symbol of a decade long unsuccessful diversification strategy. The low yielding investments must now be replaced with higher yielding investments or, like any other unsuccessful investment trust, Volvo will trade at a discount to its net asset value and open itself to takeover and break up.

Renault and Volvo are both in their different ways changing with the times in the hope of enjoying continued good fortune. In both cases the new directions represent the triumph of 1990s hope over 1980s experience. Renault is the desperate productionist which must cut labour costs to right its financial ratios; it can only become robustly profitable in the 1990s if it succeeds in opening up an advantage over its competitors which eluded it in the 1980s. Volvo is the would be financial engineer which must pursue shareholder value more successfully than it did in the 1980s. At the end of the day the most likely outcome is that (more) workers will be unemployed and shareholders will be the poorer. 'Sauve qui peut' is the law of late capitalism as the privileged social settlement of a country like Sweden collapses under the burden of accumulating stresses which undermine responsible

management's ability to balance the interests of the different stakeholders in the enterprise. Swedes may still believe their national form of capitalism is different but the merger plan tells a different story about the pressures which encourage mutation towards the Anglo-American form of dealing and financial engineering in the interests of capital.

References

- Adler P. S. and Cole R. E. (1993), 'Designed for learning: a tale of two auto plants', *Sloan Management Review*, Spring, pp. 85–94.
- Auer P. (ed.) (1990), 'Workforce adjustment patterns in four countries', *WZB Discussion Papers on Labour Market and Employment*, Berlin.
- BMW, *Report and Accounts*, various years, Munich.
- Financial Times*, London, various issues
- Guardian*, London, various issues.
- Gyllenhammar, P. (1977), *People at Work*, Addison Wesley, New York.
- International Financial Statistics Yearbook*, various years, International Monetary Fund, New York
- Machiavelli, N. (1531), *The Discourses*, repubed. Penguin Classics, London.
- Renault, *Report and Accounts*, various years, Paris
- Riegler, C. and Auer, P. (1991), 'Workforce adjustment and labour market policy: Sweden', WZB report no. FSI 91–4, Berlin.
- Womack, J. Jones, D. and Roos, D. (1990), *The Machine that Changed the World*, Rawson Associates, New York.
- Volvo, *Report and Accounts*, various years, Stockholm.

Part IV

Beyond lean production

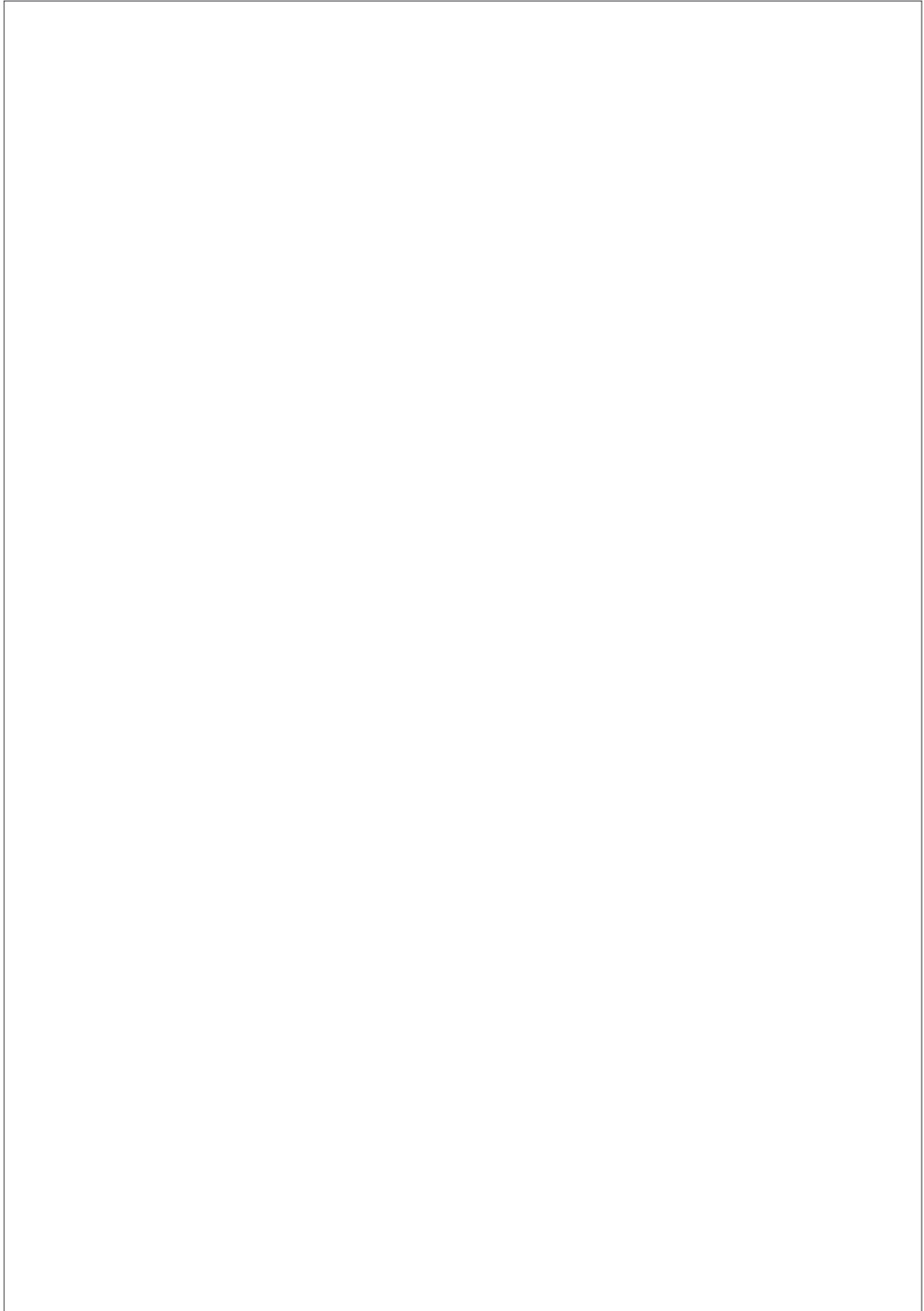

Japanese work policy: Opportunity, challenge or threat?

Norbert Altmann

While the Massachusetts Institute of Technology (MIT) study of the automotive industry (Womack et al., 1990) had the effect of stimulating discussions of Japanese work policy, it also deprived these debates of a number of important aspects. The tenets of 'lean production' continued to generate equally lean debates while the picture provided by the '5 million dollar – 5 year study' (as proclaimed on the book cover) succeeded in replacing Japanese reality. In view of the fierce competitive environment within the triad, the discussions on technology design, the organization of work and manpower utilization revolved almost exclusively around productivity issues ('half of everything'). The key issues discussed and pursued in Europe, namely the humane design of work and its productivity effects, as well as the democratic participation of employees in decision-making, were marginalized in this process. Even worse, however, was the fact that Japanese human resource management was not actually investigated, it was simply assumed to be superior to its Western counterparts. The consequences of lean production for employees and the resulting problems arising for the economy and society as a whole, as well as their repercussions on the individual enterprises and their manufacturing practices, were only discussed to a very limited extent. The following section of my paper will be dealing with precisely these issues. In doing so, some detail is sacrificed in favour of outlining structures.¹

1. The unavoidable point of departure: the lean production discussion

In Germany, as in many other countries, the summary of the MIT study rapidly achieved the status of a cult book in management, as well as, union circles. As the current debates on Japanese work policy are beset with a

number of serious problems arising from the interpretation of the MIT study, it is necessary to address this issue. A few examples should suffice:

1. The summary of the MIT study has been discussed as if it were an accurate depiction of Japanese work policy although this only applies to a very limited extent. The truth is that management perceptions are treated as reality.
2. The MIT study deals with the concrete characteristics of work organization in a circumscribed way, instead of presenting a comprehensive picture by considering the production process within the context of the economy as a whole.
3. There can be no doubt of the need to deal with productivity issues, which undeniably play a pivotal role in problems relating to the economy and industrial policies. The MIT study, however, turns a blind eye to the other side of the coin, namely the consequences for employees and the effect this has, in turn, on productivity.
4. The study also gives no consideration to the distinct forms of hierarchical and functional divisions of labour in Japan. This results in a false assessment of the actual forms of organization and respective measures prevailing in Japan (keyword: 'integration of work').
5. Accordingly, in the ongoing debates of lean production, the Japanese transplants are regarded as proof that Japanese management systems can be successfully transferred, although the American and English transplants tend to document the very opposite. In fact, Japanese management systems presuppose general political, economic and social conditions that do not (as yet) exist in Germany or Sweden (such as the virtual absence of unions). They also engender consequences which meet with limited acceptance from an employee standpoint, and are therefore usually introduced only under specific labour market conditions (Berggren, 1991, p. 42 or Garrahan and Stewart, 1992).
6. In the end, problems affecting employees, companies and societies which arise in conjunction with Japanese production modes (whether lean or not), such as the problems of just-in-time logistics, on-the-job-training, etc., should be viewed in their entirety. In Japan, lean production has not been and still is not a topic of debate, rather it is the 'crisis of Japanese management' that is discussed. One might infer that Sony's 'boss' Akio Morita was merely concerned with allaying trade conflicts when he remarked that Japanese enterprises 'do not pay their employees adequately for working hours that are too long'. However, there must be something more to it when he added that Japanese enterprises 'accept frugal profit margins and appease their shareholders with meager dividends'. These comments have given rise to much debate among Japanese employers (Satori, 1992; Takeuchi, 1992; Morita, 1992, p. 8).

All in all, it would be wise to submit the empirical foundation and the argumentation structure of the concept of 'lean production' to a critical assessment. There is one basic assumption made by the MIT study that the author of this paper ascribes to, namely that a totally culturist interpretation cannot adequately deal with the question of transferring 'lean production' concepts to other countries. While cultural, national and social traditions may have varying effects on the design of work and work behavior, one thing is for certain: the basic features of a respective production mode are transferrable, provided that decisive functionally equivalent conditions are given and the ensuing consequences are accepted (or have to be accepted). Yet it appears that posing the problem in terms of a 'question of transferral' is fundamentally wrong. The question should be whether worldwide converging rationalization strategies (as operational dimensions of productivity gains) are directed at similar or identical strategic goals. Also whether given the same strategic goals, but different social conditions and norms, other functionally equivalent ways of achieving these goals could be found without having to elevate a very specific management concept beset with problematic consequences to an ideology. This also raises the question of the transferability of 'Volvoism' or other forms of productive work organization (Sandberg, 1993).²

2. The social division of labour: the basis of work policy³

2.1 Work policy with a segmented workforce

The (various forms of) Japanese production are based on a distinctive division of labour within society. This is manifested as a 'segmented labour market' which is a key precondition of work and personnel policies in Japan. Segmented means that there are considerable differences between employees with regard to their employment and social statuses and that their working conditions also vary to a great extent in all possible dimensions (for an overview see: Tokunaga, 1984; Ernst, 1986; Ernst, 1992).

In the industrial sector the core workers, the so-called 'regular' workers, account for a maximum of 20 to 25 percent of all employees. These workers are recruited by the large scale and 'large medium size,' enterprises immediately after leaving school. (In addition there are also those smaller medium size companies who succeed in commanding a secure market position within the supply chain; in most cases as specialized firms). The core workers are the only workers who, in the long run, are able to rely on enjoying secure jobs, training opportunities, possibilities for promotion and rising income. This group consists almost exclusively of male employees (Tokunaga, 1984, p. 34).

The marginal workers consist mostly of female workers. This is generally

the case in mass production, although the automotive industry is an exception as very few women are employed on assembly lines, in contrast to supplier firms and subcontractors to the automotive industry. The group of marginal workers also comprises those female workers who were originally hired by large enterprises as 'regular' workers. This was under the implicit assumption that they would retire after marriage or the birth of their first child (with superiors exerting 'gentle' pressure in some cases), and who reenter the labour market years later as part-time or temporary workers. Apart from these groups, the marginal or 'peripheral' work force also consists of those workers (male and female) in small subcontractor firms who sometimes work directly in the production plant of the large (automotive), enterprises and under their instructions (while remaining employees of the subcontracting firm). In addition there are seasonal workers and unskilled workers who change companies from time to time. These workers do not enjoy the opportunities held by the core workers. As their wages are lower, their employment security and working conditions are less favourable in many instances and their interest representation by unions is either very poor or non-existent. Moreover, they have very limited opportunities for further vocational training. (For an overview see: Chalmers, 1989; for detailed examples see Tamai, 1992). These marginal workers form the quantitative employment buffer for lean production.

During the eighties in Japan, due to the tight labour market, this segmentation of workers had no effects on overall employment security, especially in the automotive industry. However, during the crises of the seventies, the segmented labour market allowed Japanese enterprises to flexibly adapt the number of employees (Ernst, 1988). In the current recession of 1992/93 the marginal workers are also used as a flexibility buffer (along with the prevailing practice of cutting back over-time among all employee groups). In other words, the marginal workers, who form the largest employee group by far, are not treated as 'fixed capital' as the concept of lean manufacturing purports.

Marginal workers are one major component of the segmented labour market in Japan. We will now turn to a discussion of two main features of the segmented labour market: special forms of recruitment and so-called 'life long employment'.

1. The segmented labour market manifests itself in prevailing forms of recruitment. The large and renowned enterprises (i.e., the automobile manufacturers and their first tier suppliers) recruit almost exclusively high school or university graduates directly after finishing school. As a result they are without vocational or job-related training (that means in most cases after 12 years of school, in one third of cases followed by two [female] or four [mainly male] year university programs). The decisive aspect here is the

fact that these workers are 'clean slates', so to speak, and can therefore be shaped and moulded to become readily integrated into a given corporate culture. These employees – at least the men – will join the group of core workers. The recruiting process, the efficiency of which has often been overestimated, is extremely selective. (For an example from the assembly area in the electrical sector see: Tokunaga and Altmann et al., 1991, p. 96). This highly selective procedure ensures that the large and powerful enterprises have choice access to a preselected manpower reservoir exhibiting homogeneous skills.

Toyota and Nissan formed their core work-force somewhat differently from other car companies. They also recruited junior high school graduates (at the age of 15), training them in the company school for an additional three years. After completing the company's school, they were assigned jobs in either direct or indirect production. Those who were deployed to the direct production area were expected to become supervisors, while those who were deployed to the indirect production area became 'skilled workers' (maintenance, tooling, inspection, and so on) by on-the-job-training. Both Toyota and Nissan recruit thousands of junior high school graduates every year.

Previously, the majority of large companies had such in-house schools, but in the 1960's junior high school graduates increasingly began to seek high school degrees ('Senior High School'). Many enterprises abandoned their policy of recruiting junior high school graduates and abolished the in-house schools. Recently quite a few large firms began to establish in-house schools for high school rather than junior high school graduates. A typical example is the school at Mazda. Mazda discontinued its in-house school for junior high school graduates at the end of the 60's, and at the end of the 80's founded the in-house 'Mazda Technical College' which recruits senior high school graduates for a two year training program.

It should be pointed out, that the car manufacturers in principle wanted to recruit only graduates right out of school. However, from 1959 to 1973, large Japanese car manufacturers were compelled to promote also the marginal work force (seasonal workers, temporary workers etc.) to core workers due to the shortage of young graduates on the external labour market. After the first oil crisis, the labour market became unfavourable for the workers and the car makers began to recruit their core workers exclusively from graduates fresh out of school (also from Senior High School). In the economic boom of the mid-80s, the workers again began to leave the car makers on a massive scale. Only then did the car companies once more reluctantly hire mid-career entrants as core workers.

Currently, changing attitudes to work have engendered increasing recruitment problems, even for the large manufacturing enterprises, particularly

with regard to university graduates. Due to the poor working conditions, the automotive industry has a particularly unfavourable position. According to studies conducted by the Confederation of Japanese Automobile Workers' Unions, a mere 4.5 percent of the automobile workers would recommend that their children choose a job in the automobile industry (Nomura 1992); among university graduates Toyota holds the 27th place on a list of the 'most popular' large enterprises (see a summary by Demes, 1992a, p. 484).

In comparison, smaller and less renowned enterprises – such as small and medium size companies in the supplier sector – have only limited access to better qualified individuals from the general school system at least in times of economic growth. Looking at this issue from the perspective of the 'marginal' workers, there is no access to core worker status (or at best only access to less secure forms of core work with less scope for promotion and the poorer working conditions that are offered in the small and medium size company sector). Naturally, a lower social status is also tied to these jobs.

This segmentation caused by recruiting practices, results in long term effects. The internal corporate labour markets (for regular employees) basically remain closed, careers and deployments take place within the company and without any competition from the external labour market (with the exception of some specialists). In contrast, the labour markets of the small and medium size companies are open. Those who end up in these companies will have, at best, the opportunity for further training, promotion, and higher pay in this particular sector and will have to deal with competition from the external labour market, particularly from younger individuals. In spite of the need for skills in small and medium size companies (see 2.2) the opportunities for further vocational training are limited. Those skills acquired, however, will only be valid on the labour market for similar companies with similar (inferior) working conditions.

During the period of economic growth up to 1991 the automotive industry did provide some opportunities for entry from the external labour market in some cases even with core worker status. However, this development has been discontinued due to the current economic downturn.

2. Given the considerable structural manpower shortage (see 5.2), and the declining attractiveness of working in the automotive industry, the question of employment security was not a pressing issue during the long phase of economic growth. In the meantime, however, changes are beginning to emerge. In any case, the so-called concept of 'life long employment' was always applied with considerable restrictions. This concept is by no means a Japanese 'principle' embedded in social or cultural convention or tradition (or even secured by collective agreements), its actual form arose out of the labour shortage of the post war years. It was intended to help the enterprises

secure their investments in training and the utilization of experienced employees (for literature see Ernst, 1986, p. 21, fn. 23). The conflicts arising in connection with (wage) demands made by younger workers with better (educational) credentials and the decreasing significance of work experience due to rising levels of automation and other factors, led to segmentation and had the effect of restricting life long employment to core worker groups. For older employees, their career was basically over at the age of 55 (further promotions were no longer possible even if the employee continued to work at the company – demotions were also not out of question). Currently, under pressure from the government, more and more employees are retained, with normal status, up to the age of approximately 60 years.⁴

During periods of recession core groups are retained if possible as ‘in-house unemployed’, estimated at 1 million workers at the end of 1992 (for large enterprises in all economic sectors: Handelsblatt 1993, no. 23), which tends to increase the pressure for the peripheral worker groups. ‘Voluntary retirement’ of regular employees (known as ‘shoulder tapping’) is also expected to be put into effect if the need arises and is being made demonstratively public (*The Daily Yomiuri*, 1993), the increasing publicity of dismissal of managers in large companies is a hot topic of discussion in Japan at the moment.⁵

In the relationship between buyer and supplier companies a special aspect of achieving flexibility is becoming relevant for employment security, namely the transfer of (older and/or surplus) employees (primarily white collar employees) from buyer enterprises (large scale enterprises) to suppliers (small and medium size companies). On the one hand this practice gives suppliers access to experience and skills that would not be available otherwise. On the other hand, in times of recession or in the case of rationalization measures carried out in the buyer enterprises, supplier companies are pressured to absorb workers who are not always adequately qualified or capable of fully meeting their needs. Naturally, this hampers the dependent companies from carrying out independent personnel policies. This problem also arises when qualified, (older) employees are transferred who subsequently block the upward mobility paths for existing employees in the smaller and medium size companies. (Apart from the supplier chain, the same also holds true for transfers to various plants within corporations.) Permanent transfers, even regional ones (especially for white collar employees), usually entail less favourable working conditions for workers, as well as, negative social aspects (especially for families).

The lower the position a company occupies within the supplier pyramid which is also dependent upon the particular branch of the given supplier – the more such firms will be dependent on female part-time workers (and other workers holding insecure precarious positions, including family

members). This then makes it all the more difficult, or even impossible, to recruit more highly skilled (male) workers. 'Part time' female workers, who currently account for one seventh of all employees and whose numbers are increasing, are defined more by their status than their working hours. They receive lower wages than male workers or core workers and they do not incur any training costs. (In this context, it should be pointed out that these employees also have a twelve year education and could be trained in a short period of time). One must also consider that the term 'part-time work' does not mean half-time or something similar, but simply means less regular working hours than a full-time job. Therefore, these workers can serve as an excellent buffer.

Particularly in supplier firms, the demands for the legalization and regulation of foreign workers are becoming increasingly vocal (although in the economy as a whole foreign workers play a minor role, they are indispensable for many suppliers, see JLB, 1992, p. 4).

2.2 Intensification of the division of labour through the type of training

The organization of training within Japanese companies increases the division of labour, especially in direct manufacturing and assembly work.

1. In this context, training refers primarily to on-the-job-training. These measures are not oriented to providing broad basic training in the sense of 'vocational' training, nor are they a 'practice oriented' variation of systematic professional training. However, this on-the-job-training is also not, as is often assumed, training to become a 'generalist' (who, if selected by their superiors, may be given opportunities for advancement). Even in large scale Japanese enterprises, training is basically adaptation oriented, in other words, adaptation to current and specific company needs. At least for the large enterprises, the skills workers acquire have 'enterprise-use-value' but have no 'labour market exchange value' (Georg, 1990, p. 44). The time devoted to training measures is often overestimated for the shopfloor level (but also for higher hierarchical levels), whereby the factor of training 'clean slates', i.e., training employees with a total lack of previous vocational training must be considered. Training remains company-, process- or even machine-specific and is derived from experience rather than formal instruction. The chances employees are given to develop depend strongly on the respective forms of work organization and if the worker will remain employed within the (large scale) enterprise. It is, except for specialists, virtually impossible for individuals to derive any substantial financial benefits from acquired skills (particularly in terms of a career) on the 'open' labour markets, since wage increases depend on seniority and in-house personnel evaluation (see 3.2).

In certain cases training measures are carried out off-the-job. These courses, which are available to core workers only, are usually of a very limited duration and are oriented to adaptation or promotion (see Demes, 1992b). Longer and more systematic training measures off-the-job are only available to a limited group of employees. This applies to workers performing repair and maintenance tasks not integrated into direct manufacturing work, or workers implementing new facilities who are earmarked for their operation at a later date, for example. (For a survey of training issues see: Dore and Sako, 1989; Münch and Eswein, 1992; Georg and Sattel, 1992).

2. Generally, the access to corporate further training measures depends on whether a worker belongs to the group of male core workers and on being chosen for such measures by his superiors. These measures, however, cannot be regarded as 'further training' in the sense of broadening basic qualifications, since they are also oriented to company and operational needs. The training measures are usually carried out by the company's own skilled workers or specialists and not by instructors having undergone didactic training. At the same time, these measures form the stepping stones of individual careers and are limited accordingly. Individual or company initiated private training activities outside of working hours are recorded in the personal evaluation (as an indication of motivation), yet are rarely taken into account in workplace deployment (Tokunaga and Altmann et al., 1991, p. 149).

3. The 'polyvalence' claimed to be an important characteristic of lean production, i.e. versatile and multi-faceted skills as the basis for flexible manpower utilization is in reality more the competence to deal with tasks belonging to the same level of work requirements. In other words, a broader scope of skills but not higher ones. It is essential to understand that in Japan training in general takes place within the context of a rationalization strategy, based on a workplace and process design which follows the principle that the simplest work place or process is the best ('simple is best'). It is also believed that all tasks should be standardized to the greatest extent possible until the next changes become necessary. This also holds true, for example, for the frequently quoted multi-unit tending or for the U-line organization: Apart from ensuring more intense utilization of employee performance by eliminating system losses without dispensing with the highly Taylorized form of work, these concepts offer companies considerable flexibility benefits (by bundling or separating short cycle operations and altering manning levels). While such concepts do not translate into higher skills and qualifications for employees, they do entail considerable physical and mental stress.

The claims made by Japanese scientists (Koike and Inoki, 1990), but also

by their European colleagues (see Münch and Eswein, 1992, p. 152; Staudt and Rehbein, 1988, as examples of German publications) that Japanese workers are highly skilled and command versatile skills thanks to a particularly efficient company training system must be refuted for the entire industrial sector and especially the automotive industry – at least for the shopfloor level (see Demes, 1992b; Demes and Jürgens, 1989; Tokunaga and Altmann et al., 1991, p. 139; p. 178, for an example from the electrical industry).

4. On-the-job training has several organizational preconditions, including the explicit integration of training activities into the range of tasks to be performed by experienced workers so that these workers are not subject to additional burdens in performing their other work tasks, as well as, an appropriate wage system. (The wage system is more or less independent of the workplace requirements and largely neutral in terms of work assignment; it is individually oriented and tends to be performance-related, whereby the term performance comprises individual and collective parameters as well as the demand for total work commitment ('the entire person')).⁶

Within the small supplier firms skilled work is frequently restricted to a few individuals, in many instances to owners working in their own firms. Due to time pressure and the lack of skilled personnel, as well as, the lack of government vocational training programs, it is virtually impossible to carry out extra training measures. Only the top tier suppliers receive support from buyer enterprises in the form of training and in such instances the respective measures are very specific and determined by current requirements.

One of the key preconditions ensuring that this system functions as a whole is the comprehensive twelve year school education that is not vocationally oriented and of which 90 percent of the present school graduates have undergone. Although this educational system is not free of weak points, the significance of the discipline it imparts, its strong group focus and the competitive spirit instilled in the individual are remarkable elements, to consider as the background of work policy measures in Japan.

2.3 The organization of work and control of workers stabilize the division of labour

The concept of lean production defines company work organization as integrative (work tasks), open (in functional and hierarchical terms), decentralized (units bearing responsibility) and codetermining and coresponsible (bottom-up decision processes, responsibility for quality). The MIT study, by the way, made little mention of these aspects and did not investigate them. It is doubtful, however, to what extent these concepts are actually put into practice. In Japan too, work processes are organized according to Tayloristic principles; in their pursuit for more rationalization, industrial engineers

cooperate closely with direct superiors. Quality circles and improvement efforts routinely make use of work study methods – in other words, ‘the Japanese out-Taylor us all’ (Schonberger, 1982, p. 193). This holds true in spite of the fact that the organization of the manufacturing process as a whole deviates from Taylorism.⁷ In the following, we will only be dealing with group or team work (‘the heart’ of lean production, according to Womack et al., 1990, p. 99) and hierarchical structures as examples.

1. In Japan, task integration and team have a fundamentally different meaning in terms of contents and concepts than in European discussions (and particularly those in Sweden and Germany); they involve different personnel policies and have different consequences for the effected workers.

In German debates the topic of ‘team work’ refers to the interaction between different team members with different training backgrounds (such as skilled workers and semiskilled workers), as well as, to the latitude for planning and taking action with regard to work content and scheduling, and the reduction of formal hierarchy (for an overview see Roth and Kohl, 1988). Designing technical facilities, control systems and programmes so as to be compatible with team work is at least striven for (as evidenced in a number of assembly processes or manufacturing islands⁸. The participation of representatives of employee interests is also intended (in the manning of assembly groups, for example⁹).

Berggren called attention to special aspects of Swedish team work models such as the scope they give employees to take action, the reduction of hierarchical control and the unions’ influence on forms of organization (Berggren, 1991, p. 302, p. 326); team work as ‘social compromise’ (1991, p. 327).

This elucidation of teamwork is important because the various points have nothing to do with ‘group work’ as it is practiced in manufacturing and assembly in Japan. Groups in these areas are defined in a highly formal manner, and are strictly oriented to certain sections of the manufacturing process (for example in the final assembly of automobiles; adjusting or mounting special parts in an assembly process in the electronics industry; certain machine groups in manufacturing). Perhaps the MIT study’s claims of the ‘widespread’ use of ‘team work’ in the automobile industry can be attributed to the existence of the ‘Hancho’ (Krafcik, 1988), a group leader without management responsibilities, who is more an assembly line leader, or ‘first’ man in the Western sense. A ‘Hancho’ is not to be confused with a team speaker (as at Volvo, for example) and he is naturally chosen by management, not elected by his colleagues. Japanese ‘work-groups’ have no scope for independent action, planning or scheduling and the individual work operations are highly standardized and strictly monitored. In processes with a higher degree of automation, the lack of decoupling from automatic

stations or machinery, results in tight integration into short cycle times in conjunction with high working speeds. The idea that workers can manage their own time (in German: 'time sovereignty') is an illusion, especially where Just-in-time organization is practiced.

In most cases, workers rotate only within a certain process area and by orders issued by superiors. The companies enjoy a very flexible utilization of manpower as the tasks have been levelled out so that the demands made on workers are more or less homogeneous, and low in the final assembly sector.

Tight manning levels are a basic principle. In view of the zero buffer and zero defect requirements, this results in massive social pressure within the group. Absentees put a burden on their colleagues. The low absenteeism rates have less to do with commitment or corporate loyalty than with the pressure exerted by colleagues and direct superiors.

As Jürgens aptly commented, '... it is doubtful ... whether team work exists at all in Japanese plants' (Jürgens, 1992a, p. 48; see also Jürgens, 1992b, p. 27), especially if one has the European concepts in mind.

Division of labour also exists between groups performing different functions and with different skills. The so-called 'integration' of work tasks exists only at a low level of work requirements. In Japanese industrial mass production, those groups of specialists concerned with rationalization measures or 'improvements', or the implementation of new technologies or machinery, or difficult repair tasks generally operate as separate units. The assignment of tasks to these groups of more highly skilled workers fulfilling functions that are not fixed, but are under strict control by superiors. In these groups, time pressure generates an internal division of labour ensuring that the varying skills and experience of the individual group members are optimally used under the given time constraints. Flexible manpower utilization (in all group forms) tends to be more the result of process friction, the given product mix, or output volume than absenteeism.¹⁰

A highly developed personnel evaluation system which plays a decisive role in promotion and wages, effects Japanese group work; in the orientation to the group's cooperative performance on the one hand, and competition between the members of the group on the otherhand (see 3.2).

We do not doubt the existence of a basic social orientation among the workers involved in group work, yet we do not view this orientation as being solely determined by cultural-historical factors, as a 'typical Japanese trait'. Rather educational and company personnel policy socialization measures strategically promote and sanction this orientation (see Eswein, 1988). Within the existing social and economic structure this orientation also translates as measurable benefits to the individual (in terms of promotion or career development, for example).

2. 'Flat' hierarchy is a word often heard in the discussions of lean production (see the literature on team work). The German discussions are based on a long tradition, which is characterized – at the level of manufacturing and assembly work – by the so-called 'Meister crisis' (loss of function) on the one hand, and by a 'return' of direct management tasks to their 'real' function (i.e., personnel management), on the other hand. Recently, the drive for leaner organizations has resulted in attempts to eliminate 'entire levels' from hierarchical structures, although it remains unclear where the given functions (and the employees) will wind up, insofar as it is possible to integrate the functions into direct production work, the question of coping with these functions in terms of skills and their remuneration remain open. In this respect, the general conditions of 'old' industrial locations and plants (brown-fields) and new factories in non-industrial areas (green-fields), are naturally very different.

As a generalization, it can be stated that the management pyramid in Japan is anything but flat (in manufacturing and assembly processes, this pyramid frequently comprises, with the foreman, four or more steps). On the shopfloor, the number of supervisors is high, thereby ensuring very tight control. Management positions, especially foreman and Meister (Kumicho and Shunin, but not the Hanchō), have all decision making power.¹¹

To a very limited extent, considerations aimed at 'flattening' hierarchical structures are currently emerging in a number of leading enterprises such as Toyota, although their orientation is completely different from what is being discussed in Europe. These experimental concepts envisage individuals assuming a management position for a specific project over a limited period of time, while retaining their former social status and title (Nomura, 1993, p. 43).

In general, however, the number of supervisors is comparatively high and there is a dense span of control. There are numerous and very subtle hierarchical levels. It must also be considered that some positions do not entail any management functions or rights, but represent formal promotions created in order to absorb some of the competitive pressure among the core employees. (The status positions with their respective titles, symbols and wage groups also serve to classify specialists and other employees with higher skills). Within the extremely authoritarian structures of Japanese companies, superiors fulfill more far reaching social functions than supervisors in Western countries. In Japan for example, superiors exert influence on young workers' parents, concern themselves with private affairs and apply pressure if necessary. They wield highly effective sanctions to this end, particularly those related to personnel evaluation (see below).

The frequently quoted bottom-up decisions play no role at all on the production levels, and their role on higher, 'white collar' levels is very limited.

Participation in decision making processes is primarily geared to securing acceptance; it is virtually impossible to deviate from basic decisions that have been already made.

To summarize, on the 'dual labour market' the social division of labour is intensified by the differing opportunities of gaining access to training. This means the forms of work organization tend to stabilize this division of labour more than eliminating it.¹²

3. Work policy instruments: securing the integration and utilization of manpower

3.1 The improvement process enhances motivation and secures process stability

The improvement process is regarded as one of the key elements in the concept of lean production. In it, aspects of rationalization policies and personnel policies converge in such a way, that the one can no longer be separated from the other. There are different perceptions and interpretations of the concept of 'improvement'. The definition of 'improvement' ranges from the philosophy of production policy as a whole ('Kaizen'; Imai, 1992) to more concrete terms denoting employee suggestion programmes. 'Continuous improvement process' covers the concept in the most neutral way.

The authors of the MIT study refer to the 'creative tension' (Womack et al., p. 102) in which workers are placed (given the zero defect/zero buffer situation) in a production process that is susceptible to breakdown. Improvement activities are primarily intended to smooth and facilitate the process and are measured solely in terms of productivity gains (and to a much lesser extent in terms of work safety). From this situation improvement activities certainly have the effect of stabilizing the 'fragile' work process divested of all personnel and material buffers in order to achieve the determined schedules, volume and quality demands. Improvements, however, only define new work and performance parameters, but do not create any new scope for employee action or reduce strain on the workers (until the next changes occur, operations are standardized and deviations not tolerated – this is a declared objective of Kaizen).

Particularly in mass production, Japanese middle management regards the special function of the improvement process on the shop floor level as primarily consisting of workers identifying flaws in the production process. Workers are not involved in solving such problems. In Japanese mass production, anything that lies beyond the correction of minor issues is placed in the hands of specialists. Secondly, Japanese managers repeatedly point out the fact that participation in the improvement process plays a significant role in terms of motivation, while the rationalization effects actually achieved

are rather limited. Thirdly, the number of improvement suggestions brought forward by individual workers is an important factor in personnel evaluation (the target number of suggestions is actually specified).¹³

The improvement process is also characterized by a pronounced division of labour. This applies primarily to manufacturing workers and the lower level supervisors. Apart from the manufacturing workers there are also functionally separated groups of indirect workers in the manufacturing area ('improvement teams', 'engineers on site'), whose main task is to carry out improvement measures in the sense of incremental rationalization and smoothing out of manufacturing sequences (in connection with the process of problem identification, not problem solving by production workers).

What are the consequences for the workers? On the one hand, they attain – through the productivity orientation of the entire system – continuously reduced standard times and increasingly 'leaner' work content with tighter manning levels. Financial premiums are minimal. Apart from recognition in the personnel evaluation, the most important effects of participating in the improvement process are the feeling of being heard and accepted. Thanks to this involvement, the workers experience that 'the hierarchy' reacts to their input – regardless of the concrete effects for them.

It should be kept in mind that the motivation behind the 'continuous improvement process' ('CIP') tool also includes the permanent monitoring of behaviour on the job and working attitudes. (This may make workers afraid of making mistakes which may hamper their creativity.) The identification of points of friction within the manufacturing process and their elimination by specialized rationalization experts results in a considerable intensification of work. 'Kaizen' does not imply any 'participation' (or co-design or codetermination!) at the workplace; and finally Small Group Activities do not translate into significant training effects for the workers since the topics are handed down by superiors and the process is closely controlled.

Staff cutbacks, such as dismissals, which are the result of rationalization suggestions, are very rare occurrences. It is the core workers that are the employees mainly involved in the improvement process, but naturally there are 'abstract' reductions in the total number of jobs, at least in times of economic growth.

There is one decisive organizational trend in Japanese work policies that I would like to call attention to and briefly summarize: It is not the much quoted integration of job tasks, the comprehensive scope of skills, or the continuous improvement process that secure process flows and their efficiency. It is far more the cooperation between the different functional areas, skill levels and hierarchical levels that achieve this degree of efficiency. This involves, for example, the permanent contact maintained by 'engineers' (this term must be understood in the broadest sense), and technicians with

the production level and their willingness to 'get their hands dirty' if need be. Moreover, it is the existence of a multilayered and closely knit network of middle and lower level supervisors and specialists, capable of listening and reacting swiftly which secures the production flow. Thus, in Japanese manufacturing, a high division of labour does not necessarily imply that barriers are erected between different workers, functions and manufacturing areas. There are many aspects of training and culturally determined socialization, as well as disciplinarian measures, which address this basic willingness to cooperate. Also, it should not be forgotten that this willingness – or pressure – to cooperate has very definite effects on the personnel evaluation the individual worker receives.

3.2 Evaluation as the 'heart' of work policy

1. While the features of Japanese work policy we have outlined thus far are indeed key characteristics of lean production, a main instrument of control, sanctions (or incentives) of the Japanese personnel policy often is not adequately represented in such discussions – that is the personnel evaluation system. If it holds true, as Womack et al. claim, that the 'workteam is the heart' of manufacturing activities, which I can neither confirm nor contest, then the personnel evaluation system is, in our analysis, the 'heart' of Japanese personnel management.

Historically, the personnel evaluation system has played a pivotal role in the enterprise, in terms of both the interests of control on the part of the company as well as the interests of younger employees in the period of manpower shortages during the sixties¹⁴. The personnel evaluation system was initially used as a countermeasure to the prevailing 'seniority wages' that were oriented solely to the employee's length of service. Accordingly this measure met with a great deal of acceptance from some workers, while it engendered conflicts with senior employees as both aspects (performance and period of service), retained their tense relationship with one another. The personnel evaluation system is certainly the strongest personnel policy instrument Japanese management commands.¹⁵

Presently personnel evaluation has considerable effects on the assignment of jobs, individual careers and income. The criteria applied are highly differentiated and are often dealt with as 'highly confidential' in many enterprises (Special Enquête, 1988; Tokunaga and Altmann et al., 1991, p. 153; Demes, 1989a; Endo, 1991; 1992a). In spite of a number of corrective mechanisms the personnel evaluation of workers by supervisors is systematically subjective. A considerable amount of effort is invested in this process which '... is reminiscent of the effort expended on work studies and workplace related performance profiles in Western companies' (Demes, 1989a, foreword by Jürgens).

Here I would like to refer once again to Japanese group work, as the methods utilized in employee appraisal solve one of the central problems of these groups, namely generating cooperation, and 'harmony' while at the same time promoting individual competition among the workers within the group (an aspect we will not be dealing with in greater detail). As personnel evaluation is a continuous process and is partially oriented to potential individual performance in the long run and in part is closely related to short term productive performance (normally only applied to the core workers and enterprise internal), this rating is exceptionally important for the employees. This evaluation leaves an ineradicable imprint on further careers and thus, on the work and life situation. It also determines, amongst other factors, the (in some cases) considerable deviations in company-related and age-determined income increases.

2. In Japanese industry, wage systems exhibit a similar basic structure, while their individual, enterprise-specific forms deviate widely. In all instances, wage systems are very complex and closely linked with the employee appraisal systems (Nomura, 1987; Takagi, 1987; Demes, 1989a; Tokunaga and Altmann et al., 1991, p. 187). Although seniority (period of service) plays an important role, especially for the core workers in large scale enterprises, the individual appraisal and performance rating is also of considerable significance. Toyota's wage system change of 1990 offers one example: Apart from the objective of achieving greater wage stability for the individual (by reducing the share deriving from productivity effects and introducing a fixed rate according to age) and establishing more transparency, the new concept tends to give more weight to individual performance than to collectively generated productivity (through competition between different groups or production 'segments'; Nomura, 1993, p. 44).

In our present context one must also consider the wage difference between automotive manufacturers and suppliers and also within the supplier pyramid, which is more pronounced in Japan than in other industrial nations. These differences, however, are less due to personnel evaluation systems, which are only rarely systematically applied in the case of second and third tier suppliers, as to other factors. Within Japan's dual economy there are many factors determining wage differentiation that are relevant in this context (see Ernst and Laumer, 1989, p. 28) and exert negative effects on the workers in the supply companies. Within large scale companies male core workers receive better pay than the female marginal workers (at the ratio of about 2:1).¹⁶ A comparison of wages according to company size, and therefore, regarding workers' income in supplier firms,¹⁷ also brings sizable differences to light. The widespread utilization of female and 'de facto marginal' male workers in small and medium size supplier firms as well as the

employment of older workers also plays a role. In enterprises that are end producers the wage increase based on the length of service comes to an end between age 55 and 60. However, in many cases such workers are transferred from these companies to dependent supplier companies. Moreover, due to the low retirement pensions and the period of time between retirement from a large scale enterprise and the first retirement pension payments,¹⁸ there is a considerable amount of pressure for retiring employees to seek further, usually lower paid employment on the open labour markets. To a much greater extent than in other countries, individuals continue to work far beyond the age of 65 (JIL, 1992, p. 74).

Generally speaking there are considerable wage and income differences between individual employees due to the use of personnel evaluation systems when measured over the entire life working time.¹⁹ The slight company internal income differentiation between 'normal', male core workers and management level employees (approximately 1:2), which is so frequently stressed in the lean production concept, appears in a completely different light in a comparison by company size: There is an inverse ratio of up to 2:1 and more, based on hourly wage, between the (core) manufacturing workers in large and those in small companies (see Yearbook, 1990, p. 116). Differences also exist between benefits such as health care, social facilities, etc.

3.3 Virtually unrestricted duration and flexibility of working hours

Long working hours are a well-known aspect of Japanese working life; in the automotive industry, the hours worked lie above the industry average and totalled an annual average of 2,291 effective working hours in 1990 (Bosch, 1993). In producer companies this figure is not so much the result of standard daily working hours as it is the many hours of overtime workers put in (1990:450 hours and more on the production level). This figure is possible due to the two to three hour 'gaps' between the first and second shift which are regularly filled by employees working overtime. In addition, many workers do not take their holidays (which are short by international comparison) and the rate of absenteeism is very low (all in all, Japanese workers take approximately half of the average annual holiday of 15 days; Yearbook, 1990, p. 268). Gerhard Bosch offers this concise summary of company working hours policy:

In spite of some minor differences, the working and operating hours adhered to by most Japanese automobile manufacturers are so similar, that it is legitimate to speak of a specifically Japanese type of time management: As the number of core workers is very limited, working hours must be continuously extended by overtime and beyond the collectively agreed standard working time; in addition, overtime is also used to cope with fluctuating demand. Japanese production planning,

yet also the negative sanction mechanisms in personnel planning, reflect the fact that companies take unpaid work in the form of unclaimed holidays for granted. Absenteeism due to illness or accidents is completely compensated for in the individual's holiday ... Thus Japanese companies are able to count on an attendance rate of approximately 95%. Even without overtime, operating periods of almost 4 000 hours per year are achieved, as manufacturing operations are only interrupted on paid holidays, but not on additional holidays ... the intensity of worker performance (is) exceptionally high. Their flexibility ... is remarkable. By drawing on overtime, manufacturing operations can be stepped up by 15 to 20% and more ... (Bosch, 1993, p. 19).

Moreover, employees in smaller and medium size companies, and especially supplier firms, are subject to additional disadvantages. In small supplier firms of the automotive industry, working hours are 25 percent longer than in final assembly companies and in the large first tier supply companies (*Handelsblatt*, 3.2.92) in spite of the many part-time workers employed in such companies. This also shows that part time workers are defined more by their status than by their actual working hours. In addition, it can be assumed that a great deal of statistically unrecorded overtime occurs in small (family-owned) companies.²⁰ During periods of economic decline this situation may temporarily change, but the contrast between the buyer and supplier remains just as intense.

One of the consequences of long working hours in small and medium size supplier firms is the restricted opportunity for recruiting qualified employees from the labour market. Long working hours are one factor which makes such companies less attractive for highschool graduates and further aggravates labour shortages for small and medium sized firms. This is also increasingly effecting the large automobile manufacturers. The production policies pursued by buyer companies (especially the demands for strict adherence to supply schedules and short term delivery of small batch sizes) forces the suppliers, despite staff shortages, to react to their customers' fluctuating volume demands. This is handled particularly by extending working hours and overtime. As Japanese law permits very small companies to work more hours per week and there is no union organization in such firms, workers do not receive better pay for additional working hours. Naturally, this is also the case with the part-time workers who are generally paid according to a fixed hourly wage (the hourly wage is roughly one third of the hourly wage paid to core workers in buyer companies).

The only alternative to extending working hours, or maintaining the existing working time, would be the introduction of additional, manpower-saving automation, which is difficult for small companies to finance. Even in cases where this is possible, the implementation of such facilities would require

skilled workers which small firms cannot recruit from the labour market. It cannot be assumed that the reduction of long working hours that has been going on since 1991 with the onset of economic crisis, will actually be maintained once an economic recovery sets in. In the segmented Japanese labour market, economic growth will translate into greater working hour burdens for marginal worker groups and workers in supplier companies.

The 'bufferless' and synchronous integrational production entails a very tight link between the working hour structure in the buyer and supplier companies. Apart from supplier firms, the transport companies serving the supply network are also affected (see page 24). In this context, the consequences for workers (shift work, weekend work, etc.), the topic of much discussion in Europe, must not be overlooked (see page 21)).

All in all it is evident that the comprehensive, almost unrestricted control that enterprises are able to exercise over working hours constitutes a decisive precondition for other work policy measures. The present recession demonstrates the high flexibility arising from Japanese working time policies and raises doubts whether the targeted reduction of working hours throughout the entire economy ('1800 hours' per year) will actually be attained once economic growth resumes.

4. The representation of employee interests: no participation in the design of work

In Japan the representatives of employee interests are not involved in the technical-organizational design of work. These issues, at least up to now, have remained outside of the orientations and activities of Japanese unions, and this can be regarded as a basic condition of Japanese work policies.²¹ So far, the unions have neither attempted to influence the technical-organizational design of work nor developed independent work policy concepts. The 'Guidelines on Rationalization Policies' developed by some large enterprise unions and by the union umbrella organizations (in the electrical and metal industries) in the eighties were solely oriented towards the protection of employees from potential rationalization effects and not at all with the co-design of work. The guidelines have been applied, if at all, to a very limited degree in Japanese companies.

Only recently, under the pressure of increasingly intensive forms of work, decreasing corporate profits and trade conflicts²², and especially within the Japanese Automobile Workers' Union (see Confederation of Japan Automobile Workers' Union (eds.) 1992) massive criticism has been voiced regarding the prevailing working conditions. Moreover, new concepts have been formulated that address ecological and product related questions, the

problematic relationships between buyer and supplier companies and the issue of shorter working hours.

All of the union's activities up to now have revolved around the formulation of demands and not in concrete suggestions on work design. It is possible, however, that changing union attitudes, tentative at present, may gain further momentum to the extent that in the medium term it will no longer be possible to deal with Japanese rationalization strategies in major industries without considering employee interest representation. An indication in this direction is the activities of the Nissan union in response to the closing of the Zama plant in 1993.²³

In discussions on industrial labour the term 'participation' has had, and will probably continue to have, an entirely different meaning and content than in a European context for some time to come. It must not be confused with union representation of employee interests, nor with worker participation in the design of the actual manufacturing process, aimed at securing individual and collective interests.

As already outlined in connection with the continuous improvement process, participation refers to including workers in a largely predecided consultation processes, aimed at obtaining personal acceptance. Small group activities, quality circles, various motivation and incentive methods, as well as the previously mentioned cooperation between functional areas and across hierarchical levels, will create the necessary 'consensus' (in the sense of acceptance, not compromise!) and motivation. However, the design of technology and organization and personnel policy questions, as basic issues that could lead to codetermination rights, will not be up for debate. In Japan, there is a total absence of concepts relating to a 'socially compatible' design of work as discussed in Germany or as seen in the Swedish model. Workers regard given forms of rationalization and their effects as 'natural' (particularly the 'typical' jobs for female workers, for example). In this context one must consider that all of these factors have come about in a climate of strong economic growth and with the legitimation of providing a high degree of employment security.

While the company unions do not interfere with management decisions on work policies and rationalization issues, there are three areas in which the unions are active. To begin with, the unions play a role in negotiating the annual wage increases. In this context, the unions of large automobile manufacturers even try to exert a restraining influence on the company unions of supplier firms (insofar as such unions exist), so as not to endanger the buyer company's competitiveness and thus, the wages of its core workers (Nomura, 1989).

The second area of union interest pertains to working hours. While the unions of major manufacturing enterprises do not push for any relevant

reductions of working hours, they are active in achieving a slight shift from a decreasing number of collectively agreed standard working hours towards an increasing number of overtime working hours. This means they work for achieving higher wages by increasing the number of working hours with extra allowances (usually 30 percent). In the present recession, these modest union policies (working hour policies as wage policies) are achieving exactly the opposite of what was originally intended. As overtime is being cut back, workers are losing those allowances that made a major contribution to their income (in the automotive industry 25–30 percent in many cases; Bosch, 1993). The last field of union activity focuses on health and work security measures and other material benefits. From the second tier on, most of these activities are absent in supplier companies.

This particular aspect of lean production as a form of work organization ('of the 21st century', according to Womack et al. 1990; p. 278), without the participation of elected and institutionalized representatives of employee interests and in the final instance without direct 'participation' at the workplace is not given adequate consideration in current discussions. One result is that in union discussions, in Germany for example, a number of misconceptions concerning Japanese labour market structures, team work, training and 'participation' in the continuous improvement process have also lead to the misconception of the existence of progressive forms of direct worker participation in Japanese industry. At least up to now, a work policy which is based on the absence of strong unions has not been a model for European work policies. The question that should be asked is, which functional equivalents for work policy measures can be found that achieve acceptable and necessary goals such as increased productivity, but do so in cooperation with the unions. To this end, the experience gained in Sweden and Germany offers ample points of departure.

5. Japanese work policy: consequences and problems

5.1 Human resource management remains limited

Japanese work policy, that mixture of rationalization and personnel policies, does not utilize labour, even in terms of productivity, as effectively as the MIT study and the ongoing discussions in Europe would suggest. To put it bluntly, Japanese human resource management wastes a large share of its labour potential.

To avoid any misunderstanding, I would like to emphasize that this basic assumption is by no means meant to infer that we should no longer take the question of competing with Japanese (automobile) industry as seriously as we have done so far. On the contrary, I would like to draw attention to the, as of yet, unused labour potential, waiting to be unleashed in Japan.

1. Even in the large production companies (final assembly), Japanese forms of work organization do not succeed in allowing labour to unfold to its fullest extent. This applies for practically all female workers and other members of the marginal workforce. The assignment and utilization of core workers is largely characterized by the intensification of work and the extension of working hours in many areas. These are necessary preconditions for, and inevitable results of, Japanese manufacturing methods and work policies. Personnel policies are consciously and consistently geared to the principle of coping with friction arising in increasingly mechanized and automated (lean meaning 'fragile') processes, by ensuring the most comprehensive use of manpower possible, such as 'allround utilization' (Deutschmann, 1987), in a process specific perspective. Central to this approach, however, is not occupational skills, creativity or even participation, but much more the control over working time, the acceptance of work intensity, and the integration into the 'philosophy' of the corporation (or management).

2. One aspect of limited human resource management can be seen in the consequences Japanese manufacturing methods engender for employees in the supply industry. According to the concept of 'lean' production, the Japanese forms of supplier relations are a central condition for increasing productivity (Womack et al. 1990: p. 146). In lean production, buyer/supplier relations are characterized by 'rational forms' of coordination and cooperation (which places a considerable strain on suppliers). Other interpretations assume the existence of a long term 'partnership-oriented' cooperation between buyers and suppliers (Sabel et al., 1991). The work policies pursued by the majority of the supply firms, however, is without question highly restricted or predetermined by their dependency on buyer companies. These Japanese forms of cooperation are not only based on a refined (lean) system of coordination and organization in the value added chain, but also depend on different labour and employment standards prevailing on the different supplier tiers. For example, these forms of cooperation draw on long working hours, low wages and 'outsourcing' of poor working conditions (see Demes, 1989b; Asanuma, 1988; Sakai, 1990; Ikeda, 1987; 1988). While the MIT study contests the above, it does not succeed in documenting the opposite case due to an inadequate consideration of personnel policy issues, especially the conditions in the supplier industry.

In Japan, the organization of work is based on the segmentation of the labour market and on the dual structure of the economy, both of which are totally underestimated in the West. The segmentation of the labour market brings with it a representation of employee interests divided both across companies and within companies, where it is oriented only to parts of the workforce (core workers). The divergence of working standards across the

value added chain which is associated with this system, is a necessary precondition for Japanese production modes.

3. Japanese human resource management is also limited and sub-optimal in a macro-societal perspective. The almost complete exclusion of marginal and female workers from company training and personnel development measures and the lack of public vocational training measures naturally limits and segments potential supply from the labour market. The negative physical aspects of the way labour is used, such as long working hours, high working speed, etc., also prevents the full utilization of labour and most comprehensive extent; this holds particularly true in view of the increasing aging of Japanese society (see below). Thus, apart from the individual negative effects, there is the general loss of potential labour within society as a whole, which in turn has an especially strong effect on the weak companies within the supplier system.

4. In the general discussion on lean production, besides the MIT study, it is frequently overlooked that mechanization, automation and inter-company networks by means of information and communication technology, remain central objectives of Japanese rationalization strategies. There is a tendency to forget that the MIT study accredits considerable productivity gains to automation and product design geared to manufacturability (see The Boston Consulting Group Ltd., 1991). Moreover, it is frequently overlooked that criticism directed at the United States and Europe is not aimed at technology and automation as such, but at forms of work organization that do not make adequate use of them. Personnel policy remains a dependent variable of rationalization policy, in which even in Japan, the potential of labour only plays a role for narrowly defined groups of the workforce. The authors of the MIT study reach the conclusion that there is a need for increasing automation so that 'only' the highly qualified problem solvers will be left (Womack et al. 1990: p. 102). The question remains open as to how large the share of workers eliminated in the process will be, and how productive such a system will be from a general economy perspective.

There are very few branches, such as the automotive industry and consumer electronics, in which Japan's productivity per employee is actually higher than in the United States and a number of European industrial nations (Dollar and Wolff, 1993; Handelsblatt, 16.10.1992). The average productivity per employee recorded in the Japanese economy is below that of Germany (see Deutscher Industrie- und Handelstag (DIHT), 1992).

By concentrating on fragile manufacturing concepts it is easy to lose sight of the Japanese manufacturing modes in their entirety. They are not 'best practice' for two reasons: they entail a loss of individual and societal

working capacity in the long run and cannot be regarded as productive when viewed in the context of the economy as a whole.²⁴

5.2 The repercussions of work policy for enterprises and society

In almost all instances, and especially in the case of the MIT study, the efficiency of Japanese personnel and rationalization strategies is assessed in individual production units and branches of the economy. Supported by frequently overrated assessments of the industrial policies of the Ministry of International Trade and Industry (MITI), sweeping statements on Japanese competitive strength are subsequently derived. In the process, the increasingly manifest effects of Japanese work policies for the enterprise itself and for society are hardly considered.

As I mentioned earlier, the Japanese challenge to world markets should not be underestimated. What I would like to call attention to, however, is that the emerging discussion of 'Japanese management' in Japan itself, indicates that precisely those areas where work policy actually was 'lean', new developments are being undertaken or have to be undertaken.

1. Even during the current recession, the labour market situation and industrial working conditions pose considerable problems for companies recruiting personnel. The Japanese economy, and particularly the automotive industry and its suppliers, are confronted with a twofold, structural problem. (a) Given almost stagnating population growth and a strong rise in the ratio of elderly citizens in the total population, the share of the working age population is decreasing to a greater extent than in other industrial nations (Japan Institute of Labor (JIL), 1992: 10; Japan Productivity Center (JPC), 1992–93, p. 80). At the same time, the existing quantitative manpower reservoir has been largely exploited and working hours are extended almost to their limit (criticized, yet a still accepted practice). Working hours reduction are caused more by the recession than by altered work policies, and finally there is very limited availability of foreign workers (JLB, 1992, p. 4). This situation is closely linked (b) with the allocation problem: companies with physically demanding, dirty and dangerous work are met with less acceptance from younger and better qualified workers or university graduates (JLB, 1991a, p. 4, for example). The automotive industry has a particularly poor image in this respect, while the same also holds true for long working hours (see above 3.3). All the while, higher social status is an increasingly important factor for job seekers (White Paper, 1992, p. 40). Generally speaking and to somewhat oversimplify, one could say that current trends are leading away from the manufacturing industry in favor of the service sector and white-collar jobs. This holds especially true for those employee groups who have been of particular significance to date for the rationalization process in the

automotive industry and its suppliers (graduates of technical disciplines or computer scientists, for example).

During growth phases, the 'normal reactions' of enterprises would have been to change wage forms and level, create openings for new employee groups from other companies, and utilize the flexibility buffer provided by marginal workers. However, in the present situation this is no longer possible in the automotive industry. There is increasing pressure on companies to improve working conditions, and especially to reduce working hours (for a summary see Demes, 1992a, p. 483). At present it is completely unknown whether the so-called 'new factories' (such as Nissan's 'Humane Land' in Kyushu, and Toyota's 'worker friendly' assembly hall at the Tahara plant), with their forms of organization departing from the lean production model as reported in the MIT study will ever prove to be successful. The new concepts are characterized by such features as a high degree of automation in the assembly area, consideration of ergonomic aspects (for the first time), longer work cycles, buffers and stocks, more space, and shift systems without overtime, etc., in conjunction with changes in wage and hierarchy structures (International Metal Workers' Federation (IMF), 1992; Demes, 1992a; Nomura, 1993). The decisions for these new work structures and the considerably higher investments they involve over traditional plants were made during the last growth phase. However, considering the existing recruiting problems and the basic structural labour market problems that lie behind them, and given their only modest improvement during the current recession, there will be some pressure to ensure the further development of such concepts. Labour saving rationalization measures (the top priority corporate measures in 1991, the last boom year; White Paper, 1992, p. 23; p. 64), such as further automation, as well as, the pressure to improve working conditions will both have to increase in order to secure manpower recruitment for the manufacturing sector and ensure the loyalty of core workers in large enterprises. Demes even raises the question of so-called 'Europeanization' in his summary written for the volume by Tokunaga, Altmann and Demes, 1992. The traditionally comprehensive, allround utilization of labour in Japan has generated its own winds of change for the work policy of the future.

There are three other problem constellations in which work policies also play a causal role, which will be briefly outlined below:

2. At present there are considerable problems in the supplier sector, especially in companies below the first tier. In Japan, these small and medium size firms generally have very little potential for providing training, yet are subject to considerable pressure to carry out rationalization measures requiring skilled workers (as the required investment volume makes rationalization measures increasingly difficult, the number of bankruptcies

has risen accordingly, see Asahi Shimbun, 1992). Due to their working conditions, these suppliers already suffer from a shortage of skilled workers, and the latter are also subject to marked stress (working hours) due to this shortage. This results in a vicious circle lending additional momentum to the recruiting problems of such firms. Training opportunities outside of the companies (by prefecture administrations, for example), are rare and workers whom are already putting in a great deal of overtime have difficulty attending off-the-job-courses. Personnel transfers from the buyer companies rarely reach down to the lower tier suppliers and the transfers from higher tier suppliers frequently fail to meet the labour demand. In any case, these transfers are more or less measures for shunting off older and less productive workers to deal with the recession. Demands for publicly funded vocational training measures are becoming increasingly vocal (White Paper, 1992, p. 58; ISF-material). Most likely, the recruiting and training problems of the small and medium size companies will remain and generate friction and/or changes within the supplier system (for an overview see JLB, 1990, p. 5). Such problems are already in evidence in larger suppliers in connection with short development periods and the problems of recruiting R&D personnel and the stress these employees are subject to.

3. In the concept of lean production, as well as in discussions of competitive advantage, short model cycles and thus short development in general are regarded as essential. Particularly in the automotive industry and the buyer-supplier chain, simultaneous engineering is viewed as a special strength of the Japanese way of linking rationalization and personnel policy (Womack et al. 1990, p. 112, 146; Clark and Fujimoto, 1992, p. 205). However, even suppliers with considerable R&D potential (large, direct suppliers), but especially the small and medium sized firms with limited potential, are presently incapable of coping with the short development cycles in terms of personnel, work organization and manufacturing technology (a complaint voiced by all of the Japanese suppliers we surveyed; ISF-material). The vicious circle of recruiting remains a problem. While R&D personnel are 'hoarded' by buyer companies as well as production engineers, technicians in the company's service area are dismissed during recession periods. The segmented labour market makes it nonetheless difficult or even impossible for small and medium size companies to recruit these individuals. As a result, the automotive industry has already started to extend model cycle periods (from 4 to 5 years at Nissan; the same also applies to the consumer electronics sector, where cycles had been cut down to periods of several months). The number of variants is also being reduced, while the products themselves are being simplified (in the electronics industry advertising refers to such products as 'easier to operate').

At the same time, discussion of these issues has gone beyond management circles to the public arena. The still existing working hour burdens stand in stark contradiction to the 5-year plan developed by the government, employers and unions to reduce working hours. According to this plan, which has already been delayed several times, 1800 working hours are aimed for by 1996. In addition, the MITI and the Ministry of Labour are pressing to address the wasteful use of resources (material and personnel resources) associated with short model cycles and give greater consideration to recycling issues. Even inter-company oriented work policy – i.e. the organization of the supplier system – is reaching the limits of what is viable in spite of productive methods such as simultaneous engineering. At the same time, the supplier system holds no more potential for further rationalization and cost reduction (according, for example, to the corporate report by Toyota, *Handelsblatt*, 15.12.1992).

The supplier system is subject to additional burdens arising in the context of the highly praised, purported ‘partnership-based’ cooperation forms between manufacturers and their suppliers (in matters such as simultaneous engineering, know-how transfers, direct personnel cooperation, as well as increasing utilization of information technology, etc.). On the one hand, suppliers are becoming increasingly transparent for buyers, on the other hand, the latter expect suppliers to diversify their customers. This is not only an attempt to reduce ‘responsibility’ for suppliers in times of crisis. Buyers are primarily interested in suppliers being exposed to international competition in order to draw on their enhanced rationalization and product know-how at a later date. The problem of how suppliers will be able to generate the necessary synergy effects in the R&D and rationalization process under the conditions of greater diversification and transparency is the topic of much discussion (ISF-material). The balance between autonomy and control, and thus the distribution of productivity gains throughout the value added chain (Bieber and Sauer, 1991; Sauer, 1992, p. 187) remains unsolved in Japan as elsewhere, with necessary consequences for employees in supplier firms.

4. The JIT system is regarded as the pivotal element of Japanese manufacturing methods in the automotive industry. At present, this concept has also reached its limits in several respects, including work policy (JLB, 1991b, p. 4). The fact that other branches (especially the wholesale/retail sector) have adopted JIT principles has placed such an enormous strain on under-developed traffic infrastructures that reliable just-in-time deliveries can no longer be guaranteed. If the present developments progress in a linear manner, traffic will increase by an estimated 20 percent by the year 2000. Large assembly plants erected in remote regions, distant from metropolitan areas (in Kyushu, for example), as a response to the labour market situation,

naturally create longer delivery channels. It is being overlooked that it is precisely the jobs in the transport and haulage trade that are among those no longer meeting with acceptance (due to factors such as long and irregular working hours, night work and work on holidays, long absence from home, heavy physical work, poor working conditions and low wages; Japan Trucking Association 1991) and that this could have severe consequences. Given the further extension of the JIT system and considering the targeted reduction of working hours, the government estimates that between 800,000 and one million drivers (an increase by 66 percent) will be required by the year 2000. A figure that the Japanese labour market cannot provide (Demes, 1992a, p. 482). At the same time, the transport companies find themselves confronted with increasing economic problems such as: smaller loads, demands for shorter delivery times, negative sanctions imposed in the event of delays, and rising personnel costs. All in all, these are burdens that the transport companies cannot or will not be able to cope with. Here too, The Ministry of International Trade and Industry (MITI) and the Ministry of Transport are pressing for the introduction of new logistics concepts (even keeping stores) and especially the consideration of ecological aspects! This is another area in which inappropriately lean rationalization concepts have outstripped themselves, not least for personnel policy reasons.

In conclusion it would seem that Japanese work policy, integrating personnel policy and rationalization policy, perhaps have not reached their limits, but it is currently confronted with considerable problems in a number of respects. Reflections of alternative forms of work policies which achieve productivity gains and thereby enhance competitive strength, should not be blocked through a fixation with the past success of the Japanese automobile industry. Our brief look at the effects of Japanese work policy has revealed problems for workers, enterprises and society, which, in the end, will result in consequences for the production mode itself.

The unique challenge we are currently facing in Europe consists of meeting worldwide converging rationalization objectives by developing work policies that adequately cater to the needs of society and the economy, while at the same time providing more humane forms of work. In view of the problematic aspects of Japanese work policies, neither the social nor economic goals can be adequately met by limiting solutions to the European status quo, nor by merely seeking to catch up with the Japanese. In conclusion, one must consider the fact that Japan has a tremendous latent potential of labour capacity that has remained relatively underdeveloped thus far, but one which surely will be mobilized in the future.

Notes

1. This paper refers to the mass production sector (not just the automotive industry) and to production and assembly work on the shop floor level, while omitting the white collar sectors (such as R&D, for example). Although it would be most desirable, the current paper does not differentiate between different industrial branches or enterprises. The supplier industry is only dealt with in terms of its basic structures. The text was completed in early 1992, therefore the consequences of the current economic downturn in Japan (1992/1993) are not discussed.
2. The following treatment is based on research of Japanese work policies conducted at the Institute for Social Research, ISF Munich, since the beginning of the eighties and focusing especially on mass production (automotive industry, particularly the supplier industry, but also the electrical industry). These projects were conducted in connection with research on the automotive supplier industry in the FRG and theoretical work on 'systemic rationalization'. Apart from the author, the team of researchers includes Daniel Bieber, Manfred Deiß, Volker Döhl, Dieter Sauer (Altmann and Sauer, 1989; Bieber and Sauer, 1991; Deiß and Döhl, 1992; Sauer, 1992; Altmann, 1992a; Tokunaga and Altmann et al., 1991; Tokunaga, Altmann and Demes, 1992). I would also like to thank Klaus Semlinger, who is investigating the same issues especially in the small size company sector, for his valuable insights, Pamela Meil (also from ISF) and Masami Nomura (University of Okayama, Japan), for their helpful comments. The literature referred to in the following is selective and consists mainly of publications from German speaking countries and associates of the ISF Munich.
3. The term 'work policy' denotes all of the design measures pertaining to personnel and rationalization policies (technological and organizational) affecting the regulation of work within companies, as well as, that of dependent companies (suppliers).
4. Naturally small and medium size supplier companies also seek to retain their employees, which results in peripheral workers also serving the firm for a long time. Due to the tight labour market, the repercussions for the company's image and for reasons of social responsibility, Japanese companies try to avoid laying off employees. Concerns which are by no means so 'typically Japanese' as to be conspicuously absent in other industrial nations.
5. Above a certain hierarchical level, such managers can no longer be members of the (company) union and thus are not represented by the union.
6. It should be noted that there is no formal division between 'employees' and 'workers' and therefore no division of the respective training forms. Naturally, 'white collar' and 'blue collar' workers perform different functions, as well as treading different career paths, etc. While a certain scope for permeability is pre-served in principle, it is soon restricted by the way in which individuals enter the company, as well as by personnel evaluation and task assignment. In

the following we will not be dealing with these issues. In Japanese enterprises there is also no differentiation between 'skilled' and 'semiskilled', although in many large enterprises this is identical with the differences between male and female jobs.

7. See Tokunaga and Altmann et al., 1991, chapters IV-VI; and Jürgens et al., 1989, p. 39, with a different emphasis.
8. An example is Mercedes-Benz Rastatt, see *Automobil-Produktion*, 1992, p. 128; Springer, 1992; for Opel see Minssen et al., 1991; Gesterkamp, 1992.
9. The company agreement Nr. 179 at Opel-Werke, 1991.
10. Naturally, skilled team work is also to be found in other sectors, such as in machine building. Team work is primarily encountered where male workers are employed (core workers!). In these areas, teams are formed comprising members with different training backgrounds (with 2 and 3 year training, sometimes off-the-job training), as well as workers with differing amounts, but nevertheless company specific experience. In all processes organized according to line principles, and especially those with female workers, such teams do not exist.
11. See for mass production in general: Tokunaga and Altmann et al., 1991, p. 79 and p. 123; Jürgens, 1992b, p. 28; and Clark, as early as 1979, p. 104.
12. In view of the social division of labor (and considering the additional relevance to the working time issue (see 3.3)) a paper dealing with the supplier system alone would be justified. The Japanese supplier system is a precondition for the work policies that exist in the automotive industry, as well as a work policy instrument in its own right which allows the buyer companies to shift problems of flexibility, loyalty and cost reduction, etc., to the supplier chain. In this context, the work policy measures and limited scope for independent action in the supplier firms should also be investigated. For reasons of space, however, we will not be able to discuss these questions. The consequences for employees in supplier firms will be summarized at the end of this paper (see 5.1).
13. There is a profusion of material available on this topic; on the one hand the comprehensive concept of 'quality orientation' is dealt with, which in turn is regarded as a Japanese 'characteristic'. De facto, however, this concept was adopted as the result of work policies (introduced by American management consultants) and implemented by management circles in conjunction with strategic sales market policies. The available literature also discusses 'quality circles', a widely employed tool in Japan (Beriger, 1986). The practice and design of quality circles is conceptionally well known in the West, while its concrete aspects are largely unknown (Yahata, 1987).
14. Personnel evaluation was first introduced in the twenties in the large companies. During the war, evaluation was discontinued in light of the very tight economic situation. Only after economic stabilization in the 50's, personnel evaluation was once again intensified and further developed.

15. The powerful position of authority that direct supervisors hold over production workers has been based in large part on the personnel evaluation system since the second half of the fifties (after the traditional 'feudal' structure of the prewar period fell under a great deal of criticism from management circles and the still powerful unions). As a result of rapid technological developments the 'new foreman' was no longer integrated into a potentially militant union, as was the case following democratization in the early fifties; the new foreman was called on to fulfill more personnel policy functions, particularly in conjunction with the implementation of new manufacturing methods and new products. This involved employee training (for which the foreman was prepared using mainly the American methods of 'training within industry') and the personnel evaluation system. This development was also advanced by management interests in curbing union activities, or guiding them in a direction that would serve corporate interests (employee activity in unions is recorded in the evaluation - negatively if necessary - although not official (see a case study from the wholesale/retail sector reported by Endo, 1992b).
16. In view of the overwhelming proportion of male workers, this factor does not play a decisive role in automobile companies.
17. The difference in wage costs between manufacturers and lower level suppliers, exhibits an average ratio of approximately 3:1, Handelsblatt, 3.2.92; for an overview see: Hirasawa, 1990.
18. This period has become increasingly shorter over the last few years, and is an important issue of debate in social policy.
19. For an example from the electrical industry see Tokunaga and Altmann et al., 1991, p. 192, p. 220.
20. See for example the detailed case studies by Tamai, 1992, p. 398; for information on structures and an assessment of working time see Deutschmann, 1987; Altmann, 1992b; Bosch, 1993.
21. Japanese unions are enterprise unions. At present there are more than 70,000 individual unions. Normally, only the core workers hold union membership, while the union organization and interest representation of the marginal workers is rudimentary at best. In many cases, medium size companies have no representation of employee interests, and small firms usually lack such representation altogether. In Japan the total percentage of workers organized in unions has dropped below 25%.

As institutions and in terms of union personnel, the individual enterprise unions are autonomous bodies which can conclude collective agreements. The umbrella organizations, and their programs and guidelines (such as agreements on protection against rationalization) are of very limited relevance for the enterprise unions. (There is a great deal of literature on these issues, see references in Kawanishi 1992; I will quote only a few examples relating to my own work in this field: Tokunaga and Bergmann, 1984; Bergmann and Tokunaga, 1987; Bergmann, 1990; Tokunaga, Altmann and Demes 1992).

22. Decreasing profits and trade conflicts are regarded as threats to future wage developments.
23. Nissan planned (June 1993) to reassign 1500 out of 4000 employees in Zama to other workplaces (for example, machine building), and to transfer 2500 to other plants. The majority of the employees are resisting the transfers. The company union is trying to assure that no one is dismissed (see also JLB, 1993).
24. In this context the question of the control systems governing industrial policies and market policies in Japan and their underlying strategies should be dealt with in more detail.

References

- Altmann, N. (1992a), 'Convergence of Rationalization – Divergence of Interest Representation' in Tokunaga, S. et al. (eds.), *New Impacts on Industrial Relations*, iudicium, München.
- (1992b), 'Arbeitszeitstrukturen in Japan' in IG Metall (ed.), *Fachtagung 'Arbeitszeitfragen'*, 20./21. Februar 1992 in Nürnberg, München.
- Altmann, N.; Sauer, D. (eds.) (1989), *Systemische Rationalisierung und Zulieferindustrie – Sozialwissenschaftliche Aspekte zwischenbetrieblicher Arbeitsteilung*, Campus Verlag, Frankfurt/New York.
- Asahi Shimbun (1992), 'Wenn die mittelständischen Unternehmen nicht wieder Tritt fassen ...' (Leitartikel), *Asahi Shimbun Dahlem*, No. 8, 24.5.
- Asanuma, B. (1988), *Japanese Manufacturer-Supplier Relationships in International Perspective – The Automobile Case*, Working Paper No. 8 for the Conference on 'Japanese Corporate Organization and International Adjustment', mimeographed, Canberra.
- Automobil-Produktion* (1992), Sonderheft Mercedes-Benz Modellfabrik Rastatt, July.
- Berggren, Ch. (1991), *Von Ford zu Volvo – Automobilherstellung in Schweden*, Springer Verlag, Berlin/Heidelberg etc.
- Bergmann, J. (1990), *Rationalisierungsdynamik und Betriebsgemeinschaft*, Rainer Hampp Verlag, München/Mering.
- Bergmann, J.; Tokunaga, S. (eds.) (1987), *Economic and Social Aspects of Industrial Relations – A Comparison of the German and the Japanese Systems*, Campus Verlag, Frankfurt/New York.
- Beriger, P. (1986), *Quality Circles und Kreativität*, Haupt Verlag, Bern.
- Betriebsvereinbarung*, No. 179 der Opel-Werke zur Gruppenarbeit vom 4. April 1991.
- Bieber, D.; Sauer, D. (1991), "'Kontrolle ist gut! Ist Vertrauen besser? – 'Autonomie' und 'Beherrschung' in Abnehmer-Zulieferbeziehungen'" in Mendius, H.G.; Wendeling-Schröder, U. (eds.), *Zulieferer im Netz*, Bund-Verlag, Köln.
- Bosch, G. (1993), *Arbeits- und Betriebszeiten in der japanischen Automobilindustrie*, mimeographed, draft paper.
- Chalmers, J.N. (1989), *Industrial Relations in Japan – The Peripheral Workforce*, Routledge, London/New York.

- Clark, R. (1979), *The Japanese Company*, Yale University Press, New Haven/London.
- Clark, K.B.; Fujimoto, T. (1992), *Automobilentwicklung mit System*, Campus Verlag, Frankfurt/New York.
- Confederation of Japan Automobile Workers' Unions (eds.), Japanese Automobile Industry in the Future* (1992), mimeographed, place of publication unknown.
- Deiß, M.; Döhl, V. (eds.) (1992), *Vernetzte Produktion – Automobilzulieferer zwischen Kontrolle und Autonomie*, Campus Verlag, Frankfurt/New York.
- Demes, H. (1989a), *Beförderung und Entlohnung in einem japanischen Automobilunternehmen – Eine Fallstudie*, Veröffentlichungsreihe der Abteilung Regulierung von Arbeit, Science Center Berlin, Berlin.
- (1989b), 'Die pyramidenförmige Struktur der japanischen Automobilindustrie und die Zusammenarbeit zwischen Endherstellern und Zulieferern' in Altmann, N.; Sauer, D. (eds.), *Systemische Rationalisierung und Zulieferindustrie*, Campus Verlag, Frankfurt/New York.
- (1992a), 'The Japanese Production Mode as a Model for the 21st Century?' in Tokunaga, S. et al. (eds.), *New Impacts on Industrial Relations*, iudicium, München.
- (1992b), 'Qualifikationsentwicklung und Karriere in Japan' in: Georg, W.; Sattel, U. (eds.), *Von Japan lernen?* Deutscher Studienverlag, Weinheim.
- Demes, H.; Jürgens, U. (1989), 'Skill Formation in the Automobile Industry – A Comparison between West German, British, American and Japanese Enterprises' in Blumenthal, T.; Logan, C.T. (eds.), *Employer and Employee in Japan and Europe*, The Humphrey Institute for Social Ecology, Employer and Employee in Japan and Europe – Conference Proceedings, Beer-Sheva.
- Deutschmann, Ch. (1987), *Arbeitszeit in Japan*, Campus Verlag, Frankfurt/New York.
- DIHT (Deutscher Industrie- und Handelstag) (ed.) (1992), *Japanische Herausforderung – Antworten der deutschen Wirtschaft*, Bonn.
- Dollar, D.; Wolff, E.N. (1993), *Competitiveness, Convergence and International Specialisation*, The MIT Press, Cambridge/Mass./London.
- Dore, R.; Sako, M. (1989), *How the Japanese Learn to Work*, Routledge, London/New York.
- Endo, K. (1991), *Satei (Personal Assessment) and Inter-Worker Competition in Japanese Firms*, mimeographed, Yamagata.
- (1992a), 'Japan – Wo sich Wohlverhalten bezahlt macht', *Die Mitbestimmung*, No. 10.
- (1992b), *Sex and Creed Discrimination under the Satei System in the Japanese Firm*, mimeographed, Yamagata.
- Ernst, A. (1988), *Dauerbeschäftigung und Flexibilität in Japan – Beschäftigungspolitik japanischer Unternehmen in Rationalisierungs- und Krisenphasen*, Campus Verlag, Frankfurt/New York.
- (1992), 'The Changing Nature and Persistence of Dualism in the Japanese Labour Market', *IFO-DIGEST*, Vol. 15, München, September.

- Ernst, A., unter Mitarbeit von Herold, R. (1986), *Japans langer Abschied von der Vollbeschäftigung – Arbeitsmarktstrukturen und Arbeitsmarktentwicklung*, Mitteilungen des Instituts für Asienkunde No. 147, Hamburg.
- Ernst, A.; Laumer, H. (1989), *Struktur und Dynamik der mittelständischen Wirtschaft in Japan*, Mitteilungen des Instituts für Asienkunde No. 170, Hamburg.
- Eswein, M. (1988), *Gemeinschaftserziehung in japanischen Betrieben*, Peter Lang Verlag, Frankfurt/Bern etc.
- Garrahan, Ph.; Stewart, P. (1992), *The Nissan Enigma – Flexibility at Work in a Local Economy*, Mansell, London.
- Georg, W. (1990), 'Berufliche Bildung und Qualifikation in Japan – Einschätzungen und Perspektiven aus deutscher Sicht' in Deubner, Ch. et al. (eds.), *Modell Japan?* Frankfurt/New York.
- Georg, W.; Sattel, U. (eds.) (1992), *Von Japan lernen?* Deutscher Studienverlag, Weinheim.
- Gesterkamp, Th. (1992), 'Interessenvertretung in einer Gruppenarbeitsstruktur – weniger "Wachhund" denn Problemlöser', *Die Mitbestimmung*, No. 2. *Handelsblatt* (1992), 3.2. *Handelsblatt* (1992), 16.10. *Handelsblatt* (1992), 15.12. *Handelsblatt* (1993), No. 23.
- Hirasawa, K. (1990), 'Subcontracting System and Labour Conditions in Japan – Wage Differential Problem and Enterprise Size', *The Studies of Business and Industry*, No. 7, The Research Institute of Commerce (ed.), Nihon University.
- Ikeda, M. (1987), 'Evolution of the Japanese Subcontracting System', *Trade-scope*, No. 7.
- (1988), 'New Development of Japanese Pattern of Subcontracting System', *The Studies of Business and Industry*, No. 5, The Research Institute of Commerce (ed.), Nihon University.
- Imai, M. (1992), *Kaizen*, Random House, New York.
- IMF (International Metal Workers' Federation) (ed.) (1992), *Toyota Motors Towards 2000 – Report for Workers and their Unions*, mimeographed, Toyota City.
- Japan Trucking Association, Inc. (1991), *Survey on Labour Shortage in Truck Business*, Tokyo.
- JIL (The Japan Institute of Labour) (1992), *Japanese Working Life Profile*, Labour Statistics 1992-93, Tokyo.
- JLB (Japan Labor Bulletin) (1990), Kanaya, S., 'Small and Medium Enterprises – Changes and Possibilities', *Japan Labor Bulletin*, No. 9.
- JLB (1991a), Suwa, Y., 'Do Young People Really Hate "Dirty, Dangerous and Difficult" Jobs?', *Japan Labor Bulletin*, No. 5.
- JLB (1991b), Kameyama, N., 'Recent Debate over Just-in-Time System', *Japan Labor Bulletin*, No. 11.
- JLB (1992), Inagami, T., (1992), 'Gastarbeiter in Japanese Small Firms', *Japan Labor Bulletin*, No. 3.

- JLB (1993), Yahata, S., 'Relocation Arising from the Gradual Close of Nissan's Zama Plant Production Line', *Japan Labor Bulletin*, No. 7.
- JPC (Japan Productivity Centre) (1992/93), *Practical Handbook of Productivity and Labour Statistics*, Tokyo.
- Jürgens, U. (1992a), 'Ein schlankes Produktionssystem beseitigt jeden Spielraum – darum ist es schlank', *Die Mitbestimmung*, No. 4, Vol. 38.
- (1992b), 'Lean Production in Japan – Mythos und Realität' in Hans-Böckler-Stiftung et al. (eds.), *Lean Production – Schlanke Produktion*, Tagungsband, Düsseldorf.
- Jürgens, U.; Malsch, Th.; Dohse, K. (1989), *Moderne Zeiten in der Automobilfabrik – Strategien der Produktionsmodernisierung im Länder- und Konzernvergleich*, Springer Verlag, Berlin/Heidelberg etc.
- Kawanishi, H. (1992), *Enterprise Unionism in Japan*, Kegan Paul International, London/New York.
- Koike, K.; Inoki, T. (1990), *Skill Formation in Japan and South East Asia*, University of Tokyo Press, Tokyo.
- Krafcik, J.F. (1988), *Methodology for Assembly Plant Performance Determination*, IMVP Papers, October.
- Minssen, H.; Howaldt, J.; Kopp, R. (1991), 'Gruppenarbeit in der Automobilindustrie – Das Beispiel Opel Bochum', *WSI-Mitteilungen*, No. 7.
- Morita, A. (1992), 'A Moment for Japanese Management', *Japan-Echo*, No. 2, Vol. XIX.
- Münch, J.; Eswein, M. (1992), *Bildung, Qualifikation und Arbeit in Japan – Mythen und Wirklichkeit*, Erich Schmidt Verlag, Berlin.
- Nomura, M. (1987), *New Technology and Industrial Relations – The Japanese Case*, mimeographed, Paris.
- (1989), 'Beziehungen zwischen den Unternehmensgewerkschaften eines Automobilherstellers und seiner Teilezulieferer – Organisation und Aktivitäten von Gewerkschaften in der japanischen Automobilindustrie' in Altmann, N.; Sauer, D. (eds.), *Systemische Rationalisierung und Zulieferindustrie*, Campus Verlag, Frankfurt/New York.
- (1993), 'Farewell to 'Toyotism'? – Recent Trend of a Japanese Automobile Company', *Actes du GERPISA*, réseau international, No. 6, des réalités du Toyotisme, mimeographed.
- Roth, S.; Kohl, H. (eds.) (1988), *Perspektive: Gruppenarbeit*, Bund Verlag, Köln.
- Sabel, Ch.F.; Kern, H.; Herrigel, G. (1991), 'Kooperative Produktion. Neue Formen der Zusammenarbeit zwischen Endfertigern und Zulieferern in der Automobilindustrie und die Neuordnung der Firma' in Mendius, H.G.; Wendeling-Schröder, U. (eds.), *Zulieferer im Netz*, Bund Verlag, Köln.
- Sakai, K. (1990), 'The Feudal World of Japanese Manufacturing', *Harvard Business Review*, November/December.
- Sandberg, A. (1993), 'Volvo am Scheideweg', *Arbeit*, No. 2, Vol. 2.
- Satori, A. (1992), 'Suche nach Harmonie', *WirtschaftsWoche* No. 50, 4.12.
- Sauer, D. (1992), 'Auf dem Weg in die flexible Massenproduktion' in Deiß, M.; Döhl, V. (eds.), *Vernetzte Produktion*, Campus Verlag, Frankfurt/New York.

- Schonberger, R.J. (1982), *Japanese Manufacturing Techniques*, The Free Press/ Collier Macmillan Publishers, London.
- Special Enquête 1988 (1988), 'Jingi Koka Seido ha dou Unei sarate iruka', *Chingin Jitsumu* (Lohnpraxis), No. 8, Vol. 599.
- Springer, R. (1992), *Gruppenarbeit – Anlässe, Ziele und aktueller Stand – Erfahrungsbericht aus der Mercedes-Benz AG*, Vortrag auf dem Refa-Bodensee-Forum, mimeographed.
- Staudt, E.; Rehbein, M. (1988), *Innovation durch Qualifikation*, ed. Frankfurter Allgemeine Zeitung, Frankfurt 1988.
- Takagi, I. (1987), 'Determination of Wages in Japan' in Bergmann, J.; Tokunaga, S. (eds.), *Economic and Social Aspects of Industrial Relations*, Campus Verlag, Frankfurt/New York.
- Takeuchi, Y. (1992), 'Rethinking the Economic System', *Japan-Echo*, No. 2, Vol. XIX.
- Tamai, K. (1992), 'Working Conditions in Small and Medium-sized Enterprises in Japan – The Case of Osaka' in Tokunaga, S. et al. (eds.), *New Impacts on Industrial Relations*, iudicium, München.
- The Boston Consulting Group Ltd. (1991), *The Competitive Challenge Facing the EC Automotive Components Industry*, paper prepared for the Commission of the EC, London.
- The Daily Yomiuri* (1993), Jan. 4.
- Tokunaga, S. (1984), 'The Structure of the Japanese Labour Market' in Tokunaga, S.; Bergmann, J. (eds.), *Industrial Relations in Transition*, Tokyo University Press, Tokyo.
- Tokunaga, S.; Altmann, N.; Demes, H. (eds.) (1992), *New Impacts on Industrial Relations – Internationalization and Changing Production Strategies*, Monographien aus dem Deutschen Institut für Japanstudien der Philipp-Franz-von-Siebold-Stiftung, Band 3, iudicium verlag, München.
- Tokunaga, S.; Altmann, N.; Nomura, M.; Hiramoto, A. (1991), *Japanisches Personalmanagement – ein anderer Weg? – Montagerationalisierung in der Elektroindustrie III*, Campus Verlag, Frankfurt/New York.
- Tokunaga, S.; Bergmann, J. (eds.) (1984), *Industrial Relations in Transition – The Cases of Japan and the Federal Republic of Germany*, Tokyo University Press, Tokyo.
- White Paper on Labor 1992* (1992), The Japan Institute of Labor (ed.), Tokyo.
- Womack, J.P.; Jones, D.T.; Roos, D. (1990), *The Machine that Changed the World*, Macmillan Publishing & Co., New York/Toronto etc.
- Yahata, S. (1987), *Gegenwärtiger Stand und Entwicklungsperspektiven von Kleingruppenaktivitäten in japanischen Automobilunternehmen*, WZB/IVG-discussion papers 87–206, Berlin.
- Yearbook of Labor Statistics 1990 (1991)*, Policy Planning and Research Department, Minister's Secretariat, Ministry of Labour, Japan (eds.), Tokyo.

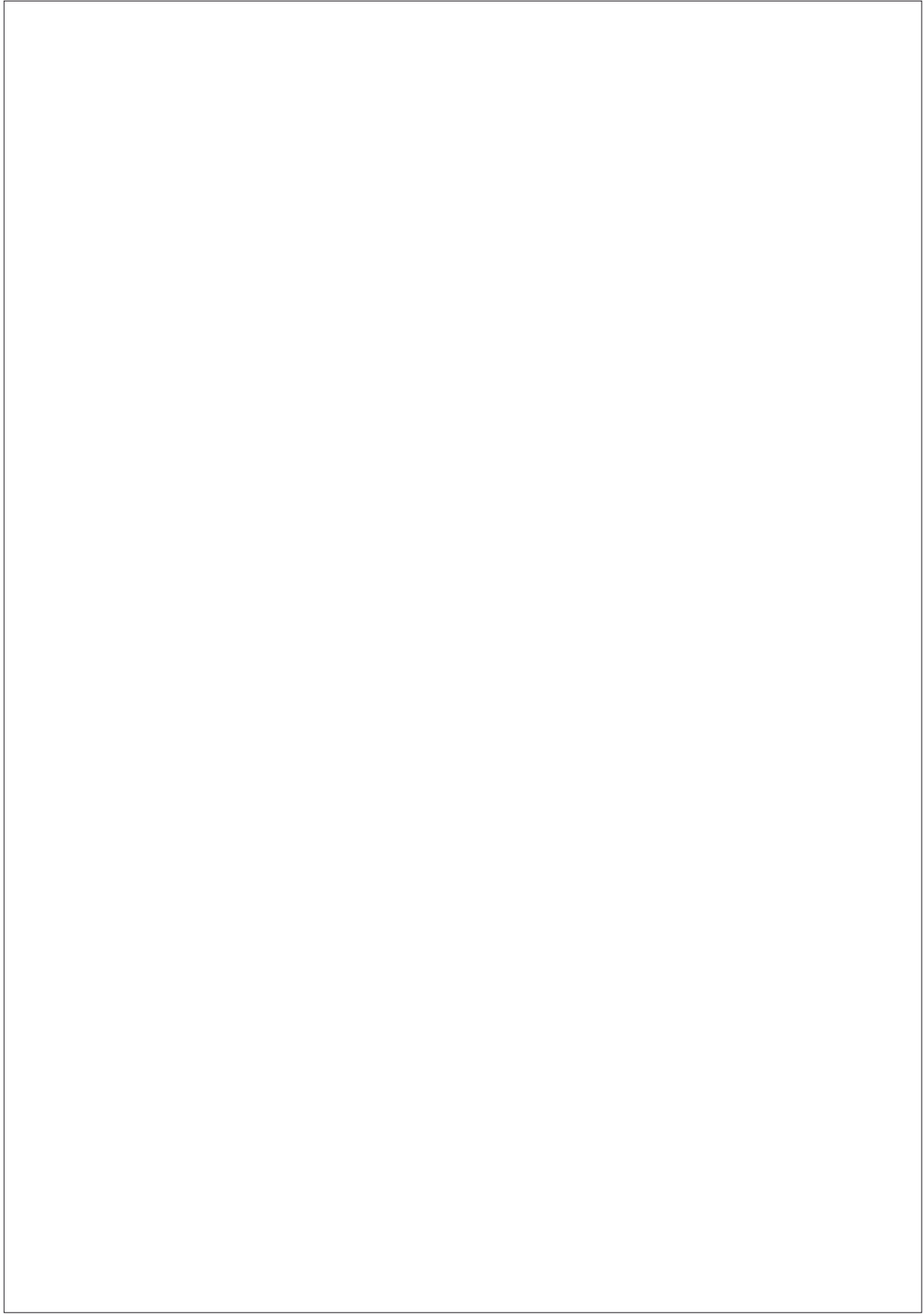

Lean production in the automobile industry: Second thoughts

Dan Jonsson

1. Introduction

Recently, so-called lean production has been heavily promoted as the ultimate manufacturing method in automobile assembly, especially in the book entitled '*The Machine that changed the world*' (Womack, Jones & Roos 1990; henceforth MCW). This book, based on the International Motor Vehicle Program at the Massachusetts Institute of Technology, is the first to reveal, according to the cover: '... How the Japanese have been able to move ahead of the rest of the world in the global auto war ... Their secret weapon: a manufacturing method called lean production ... What industry everywhere must learn about lean production to succeed in the 1990's.'

The following citations, beginning on the first page of the first chapter – 'The Industry of Industries in Transition' – reflect the missionary zeal guiding the authors:

After World War I, Henry Ford and General Motors' Alfred Sloan moved the world manufacture from centuries of craft production – led by European firms – into the age of mass production. Largely as a result, the United States soon dominated the global economy.

After World War II, Eiji Toyoda and Taiichi Ohno at the Toyota Motor Company in Japan pioneered the concept of lean production. The rise of Japan to its current economic pre-eminence quickly followed, as other Japanese companies and industries copied this remarkable system. ...

This book is an effort to ease the necessary transition from mass production to lean. By focusing on the global auto industry, we explain in simple, concrete terms what lean production is, where it came from, how it really works, and how it can be spread to all corners of the globe for everyone's mutual benefit. (MCW, pp. 11–12)

This is powerful rhetoric, but sweeping statements such as these can also evoke scepticism. In view of the strong impact this book has had on Western manufacturers, there seems to be a need for a dispassionate analysis of the logical structure and empirical validity of arguments presented therein. This chapter provides an explication and assessment of MCW's main message relating to assembly plant practices.

2. An explicated causal model

The schematic causal model in figure 1 represents an explication of the complex of ideas in MCW that will be analysed below.

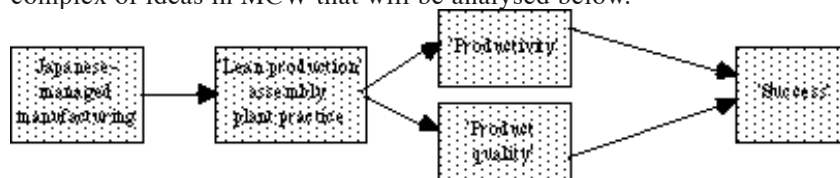

Figure 1. A schematic causal model explicating an important complex of ideas in 'The Machine that changed the world'

Note that 'lean production' is a so-called intervening variable in the causal model, so if this production method is established in plants that are not necessarily Japanese-managed, the same benefits with regard to 'productivity', 'product quality' and 'success' should be expected there. This is in fact one of the main messages in MCW.

The causal model may be expressed in terms of the following theses:

- (1) The assembly plant practice of Japanese automobile manufacturers differs significantly from that of Western manufacturers.
- (2) Japanese automobile manufacturers achieve significantly higher productivity than Western manufacturers.
- (3) Japanese automobile manufacturers achieve significantly higher product quality than Western manufacturers.
- (4) Japanese automobile manufacturers are significantly more successful than Western manufacturers.
- (5) Japanese automobile manufacturers achieve significantly higher productivity and product quality than Western manufacturers mainly because the assembly plant practice of Japanese manufacturers differs significantly from that of Western manufacturers.
- (6) Japanese automobile manufacturers are significantly more successful than Western manufacturers mainly because Japanese manufacturers achieve significantly higher productivity and product quality than Western manufacturers.

Theses (1)–(5) are argued explicitly and forcefully in MCW, whereas thesis (6) constitutes an interpretation of an implicit message. Since statements similar to thesis (6) have been made by many journalists and managers obviously inspired by MCW, and also because the relevance of theses (2), (3) and (5) is largely based on the truth of thesis (6), there are good reasons to consider this thesis as well.

3. The state of the industry

In this section, two questions concerning theses (1)–(4) will be addressed, namely ‘What are the meanings of the key terms in these theses, and how are the key concepts measured?’ and ‘What is the evidence for these theses, and what is the evidence against?’

(1) The assembly plant practice of Japanese automobile manufacturers differs significantly from that of Western manufacturers.

Table 1 reflects different assembly plant practices in Western as compared to Japanese-managed plants; practices in MCW referred to as ‘mass production’ and ‘lean production’, respectively.

Table 1
Some indicators of assembly plant practises
in Western and Japanese-managed plants (MCW, p. 92)

	<i>Japanese in Japan</i>	<i>Japanese in North America</i>	<i>American in North America</i>	<i>All Europe</i>
Size of repair area (as % of assembly space)	4.1	4.9	12.9	14.4
Inventories (days for 8 sample parts)	0.2	1.6	2.9	2.0
% of work force in teams	69.3	71.3	17.3	0.6
Job rotation (0 = none, 4 = frequent)	3.0	2.7	0.9	1.9
Suggestions/employee	61.6	1.4	0.4	0.4
Number of job classes	11.9	8.7	67.1	14.8
Training of new production workers (hours)	380.3	370.0	46.4	173.3

The data in table 1 should not be accepted uncritically. For example, the team concept as used in Japan does not correspond to the concept of autonomous teams as used in Europe, so the differences with regard to team work

reported in table 1 should be interpreted with caution. Even if important differences between assembly plant practices do exist, some claims about these differences in MCW seem to be exaggerated – e.g. the claims that lean production is ‘an entirely new way of doing things’ (MCW, p. 47) and that the introduction of lean production constitutes ‘a revolutionary leap’ (MCW’s cover). Such statements disregard the fact that lean production has retained or even reinforced traditional elements such as the assembly line, short work cycles, standardised work methods and hierarchical organisation principles (Ellegård et al. 1992).

(2) Japanese automobile manufacturers achieve significantly higher productivity than Western manufacturers.

According to measurements made in the International Motor Vehicle Program World Assembly Plant Survey, Japanese automobile manufacturers achieve remarkable productivity and product quality (see figure 2). Note that ‘assembly plant’ activities include welding and painting of car bodies as well as final assembly of automobiles.

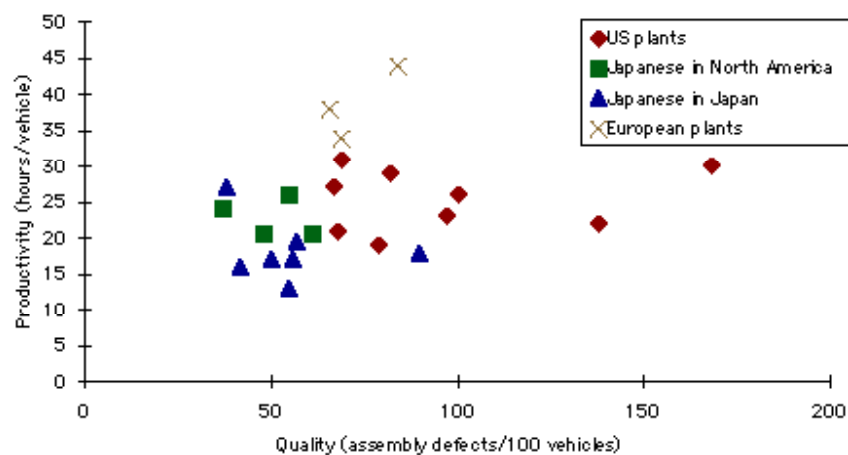

Figure 2. Productivity and product quality achieved in assembly plants (MCW, p. 93)

The productivity figures reported in MCW have been widely cited. Unfortunately, the way they have been presented and interpreted has often revealed an inadequate understanding of these figures. Several basic points concerning the meaning and measurement of productivity have often been overlooked.

First, sufficient attention is not always paid to the fact that 'productivity' in MCW refers to *assembly plant productivity*. This concept encompasses only a small fraction of all value-adding activities in the automobile industry.

Second, the measurement of assembly plant productivity poses several problems and involves some dubious or at least debatable decisions.

It is important to note that the productivity figures reported are *not* based on the number of automobiles produced and the number of man-hours spent in the assembly plant as observed during some specific period or periods of time (e.g., one year or a random sample of shifts). Instead, productivity figures are based on a standardised number of automobiles produced by a standardised number of employees during a standard shift (Krafcik 1987, p. 18; Krafcik 1988, pp. 57–58).

As a consequence of this measurement approach, insufficient attention is paid to overtime. Unpaid 'voluntary' overtime, a common practice in Japan, is not included in the man-hour counts. Nor is paid overtime included, apparently, since total working hours per shift are calculated from the (nominal) length of shifts and the (adjusted) number of workers in each shift (Krafcik 1988, pp. 57–58).

Neglecting overtime may introduce a serious measurement bias in favour of Japanese manufacturers. As an illustration, visitors to the Toyota star plant in Takaoka, Japan reported an actual working week of 60 hours in 1988, whereas the nominal working week was only 40 hours (Williams et al. 1992, p. 16).

Furthermore, the number of vehicles produced in a standard shift can be calculated by (1) dividing the number of minutes per shift by the stipulated number of minutes per work cycle for each assembly line and then adding the assembly-line capacities thus calculated, or (2) dividing the number of vehicles produced per year by the number of shifts per year. The first method (which presupposes that conventional line assembly is used) provides a measure of nominal production capacity, whereas the second method also reflects capacity utilisation. It is not clear which one, if any, of these methods that was used in the World Assembly Plant Survey.

An issue raised here concerns the relationship between productivity and capacity utilisation. Japanese assembly plants have attained high and stable levels of capacity utilisation; for example, the quarterly capacity utilisation in the motor vehicles and parts manufacturing sector as of 1991 varied from 96 percent to 101 percent in Japan versus from 67 percent to 76 percent in the United States (Williams et al. 1992, p. 20). Since low capacity utilisation affects productivity negatively, there is again a risk of introducing a considerable bias in favour of Japanese automobile manufacturers.

It should also be noted that all employment figures used in the calculation of productivity measures were 'based on the number of employees required

to operate, not the total roll-on' (Krafcik 1988, p. 57), implying that employees required due to absenteeism were not included. Furthermore, only a subset of all activities performed in the assembly plants are included in the man-hour counts reported. This subset is designed to consist of activities performed in all plants, the purpose being to improve comparability between plants performing more or less assembly work in-house.

To further improve comparability, correction factors were used to compensate for the effects of relief time, welding requirements, product size and equipment content. While such corrections are motivated, given the measurement approach, the choice of correction factors necessarily involves debatable decisions.

One concern, then, is whether the definitions and adjustments described above really permit fair comparisons between different assembly plants. Another concern is based on the fact that the man-hour counts reported in MCW are substantially lower than the gross assembly hours calculated by dividing the total hours of effort in the plant by the total number of cars produced there. In popular discussions of assembly plant productivity, the standardised net assembly hours reported in MCW are often interpreted as – and compared to – actual gross assembly hours. Specifically, fictitious man-hour counts from Japanese assembly plants have sometimes been compared to actual man-hour counts from Western assembly plants, resulting in grossly exaggerated productivity differences.

(3) Japanese automobile manufacturers achieve significantly higher product quality than Western manufacturers.

Thesis (3) is supported by the product quality data reported in figure 2. However, the measures of product quality presented in MCW can be misinterpreted unless certain crucial aspects of the measurement procedure are born in mind.

First, product quality is measured by the number of defects, that is quality refers to deviations from a standard. The issue of the quality of automobiles that adhere to this standard is not addressed. Second, only those defects that can be attributed to work in the assembly plant are included, specifically water leaks, loose electrical connections, paint blemishes, sheet metal damages, misaligned exterior and interior parts, and squeaks and rattles (Krafcik 1988, p. 74). 'Product quality' thus means *assembly quality* as measured by the number of assembly-plant-related defects, not product quality in a wider sense.

Third, the number of defects reported are based on North American customers' responses to a mail questionnaire. While it is useful to obtain customers' opinions, this procedure does also involve several problems. It should be noted that quality measures were obtained only for automobiles

sold in the United States and that the questionnaire response rate was very low, about 31 percent in 1990 (Armstrong 1991). In addition, psychological factors will inevitably influence customers' assessments of defects. For example, what is seen as a defect will probably differ depending on whether the automobile is a luxury car or a compact car, and the customer-dealer relationship is also likely to affect the number of defects reported.

(4) Japanese automobile manufacturers are significantly more successful than Western manufacturers.

As shown in table 2, the Japanese share of world automobile production increased from about 1 percent in 1960 to about 25 percent in 1989, an extraordinary performance.

Table 2
Japanese share of world automobile production (Löf 1991, p. 2)

	1960	1965	1970	1975	1980	1985	1989
World production	12 766	19 232	22 578	25 215	29 216	32 728	36 015
Japanese production	165	696	3 179	4 568	7 038	7 647	9 042
Share of world production	1.3%	3,6%	14.1%	18.1%	24,1%	26,9%	25,1%

In terms of profit margins, return on investments, dividends paid and similar measures of economic success, Japanese automobile manufacturers have not been equally successful as they have in terms of growth of market share, however (e.g., Helling 1991). This is hardly accidental. Japanese automobile manufacturers have pursued a long-term strategy, where they are willing to buy market shares in order to gain a strong market position. As they put it themselves: 'First win, then profit'. This strategy has been stimulated by the keiretsu system, which provides for financial stability, and by the extended pay-off times for investments tolerated in Japan.

Second, even if 'success' is interpreted as 'successful *market performance*', some concerns remain. Note that the Japanese share of world automobile production has not shown an upward trend since 1980. A further sign that the tide may have turned is that Japanese companies have been significantly hit by the recent down-turn for the global automobile market, while the down-turns in 1969, 1975 and 1982 did not affect them to the same extent.

Such observations suggest that the factors explaining the fast growth of the Japanese automobile industry may have been present and effective mainly

during the 1960s and 1970s. It is not obvious that because of Japanese automobile manufacturers' success yesterday, Western manufacturers should emulate tomorrow what the Japanese are doing today.

4. Determinants of assembly-plant productivity and assembly quality

Correlations thus exist between assembly plants' national affiliation (Japanese vs. Western) and their reported productivity, and also between national affiliation and reported assembly quality. These correlations are in MCW interpreted as evidence of causal relations as stated in thesis (5).

(5) Japanese automobile manufacturers achieve significantly higher productivity (i.e. assembly plant productivity) and product quality (i.e. assembly quality) than Western manufacturers mainly because the assembly plant practice of Japanese manufacturers differs significantly from that of Western manufacturers.

As discussed in section 3, the reported correlations may be exaggerated due to measurement errors. In addition, it will be argued here that even if the correlations are accepted at face value they do not demonstrate causality. The main part of any productivity and quality advantage exhibited by Japanese-managed assembly plants is probably due to other factors than lean production understood as a manufacturing method.

Four types of factors that affect productivity and quality may be distinguished: 'materials', 'machines', 'men' and 'methods' (e.g., Krafcik 1988). The salient question is to what extent productivity and quality are affected by the first three of these factors and to what extent they are affected by the last factor, 'methods'. This question is important because, to be specific, easy-to-assemble cars ('materials'), extensive automation ('machines') and skilled and hardworking employees ('men') are not defining features of lean production systems whereas a certain assembly plant practice ('methods') is.

4.1 Assembly plant productivity

As noted in MCW (pp. 96–97), the 'materials' factor, which concerns the manufacturability of automobiles, is an important determinant of the number of man-hours required for assembly work. In spite of that, manufacturability was not taken into account when assessing assembly plant productivity, with the exception of a rather crude correction for automobile size as discussed above.

'Answering the manufacturability question definitely is difficult', say the authors of MCW in defence of this omission, 'because we would have to perform what automobile manufacturers call a tear-down analysis on every

car being assembled in every plant we surveyed. Only then could we see how many parts the car has and how easily they can be assembled. This analysis would be staggeringly expensive and time-consuming.' (MCW, p. 96)

This is not very convincing, though. Standard assembly times based on time-and-motion analysis are required in all line assembly plants in order to perform capacity calculations and line balancing. Therefore, it seems reasonable to believe that such data should have been rather easy to obtain for all plants in the study. As an alternative, or a complement, data extracted from product data bases can be used to estimate required assembly times. In a study by Engström (1983, p. B6:6), the number of parts to be assembled and the type of fasteners used were found to account for 85 percent of the variation in standard assembly times.

In the absence of more adequate data, MCW refers to two minor studies on manufacturability (p. 96). In one study, eight automobile companies ranked 19 manufacturers according to the manufacturability of their products. The rankings agreed fairly well, and in terms of average rank the six Japanese manufacturers won positions 1, 2, 3, 5, 8 and 9. In another study, conducted by General Motors, it was estimated that 40 percent of the difference in productivity between one GM assembly plant and one Ford plant was due to a difference in manufacturability.

Second, a considerable part of the variation in productivity is due to some assembly plants being more automated than others (the 'machines' factor). While the actual assembly work is difficult to automate, the welding and painting of car bodies can be automated to a great extent. Fortunately, the degree of automation was assessed in the World Assembly Plant Study, and as expected automation proved to be related to productivity. Specifically, about one third of the variation in productivity could be accounted for by variation in the level of automation (MCW, p. 94).

Third, the work intensity and the qualifications of the employees ('men') also affect productivity. Obviously, if operators work harder they will complete the job in less time, and a more qualified worker will in general also do the job faster than a less qualified one if they work equally hard. If strong, healthy, tenacious, skilled and highly motivated workers are hired it is reasonable to expect higher productivity irrespective of production methods.

Again, MCW reports no data that could be used to assess such effects. Some tentative conclusions can however be drawn from reports concerning Japanese assembly plants in North America and Europe, so-called transplants. According to such reports (e.g. Fucini and Fucini 1990; Berggren, Björkman, and Hollander 1991), the work pace in these plants is quite high. More importantly, the recruitment of employees shows a clear pattern. Assembly plants have been established in regions with high unemployment, very competitive wages are offered, and a no lay-off 'guarantee' is issued.

As a result, each position in the plant attracted a large number of applicants who were subjected to an extensive screening and testing procedure. It may be argued that these plants would not have taken such trouble and accepted additional costs unless it had enabled them to recruit a labour force unusually willing and able to work hard and skilfully.

Also, Japanese-managed assembly plants are characterised by a minimal work-force (leading to much overtime work) and small variations in capacity utilisation. As a result, workers' idle time is minimised. As mentioned earlier, it is not clear whether the productivity measure used in the World Assembly Plant Study is biased by this effect.

Now, if (1) manufacturability accounts for a major part of the observed difference in assembly plant productivity between Japanese and Western manufacturers, (2) automation accounts for about one third and (3) factors such as workforce selection and work intensity account for a significant part of the difference, there is not much variation in assembly plant productivity that remains to be accounted for by the fourth factor, 'methods', which includes the lean production assembly plant practice.

In conclusion, there is not much real evidence presented in support of the thesis that superior Japanese assembly plant productivity is mainly due to some powerful, ingenious 'secret weapon' manufacturing method practised in Japanese assembly plants. Correlation is no proof of causality, and there are other plausible, indeed rather obvious, explanations of a major part of the observed difference in assembly plant productivity.

4.2 Assembly quality

The same type of analysis as in the preceding subsection may be performed for assembly quality. There are reasons to expect that product design as well as component quality will affect assembly quality. Similarly, automation and skilled and well-motivated employees can be expected to improve assembly quality by reducing process variations.

Unfortunately, it is difficult to quantitatively assess the magnitude of these three types of contributions to assembly quality – they may be decisive, but they may also be of minor importance. Consequently, it is difficult to assess the contribution of the 'methods' factor. In any case, thesis (5) is not proved in MCW.

5. Effects of assembly plant productivity and assembly quality

As mentioned in the introduction, the following thesis fits in with those considered above and is also worth investigating.

(6) Japanese automobile manufacturers are significantly more successful in terms of market performance than Western manufacturers mainly because Japanese manufacturers achieve significantly higher productivity (i.e. assembly plant productivity) and product quality (i.e. assembly quality) than Western manufacturers.

The notion that assembly plant productivity and assembly quality are sufficient to explain the market performance of automobile manufacturers neglects many other important factors. This becomes evident in asking the questions ‘What determines total production costs?’, ‘What determines customer-perceived product value?’ and ‘What factors in addition to total production costs and customer-perceived product value determine market performance?’

5.1 Total production costs

In the absence of a critical discussion of the relevance of the man-hour counts presented in MCW, readers are prompted to believe that the reported man-hour counts accurately reflect total production costs per automobile. For several reasons, this is not the case, even if it is assumed that man-hour counts do reflect assembly plant productivity accurately.

First, man-hours do not equate labour costs; man-hour reduction is a means rather than an end. As noted in section 4.1, man-hour counts may be reduced by raising wage levels, thereby making it possible to recruit an elite labour force. Such man-hour reductions will obviously not result in proportionate reductions of labour costs. Furthermore, reduced man-hour counts may also be achieved through measures that increase non-labour costs, e.g. the introduction of automatic equipment to replace manual labour.

Second, the labour costs in the assembly plants constitute only a small percentage of the total production costs. In a Swedish final assembly plant recently studied, the labour costs amounted to less than 10 percent of the costs for materials alone. Even though labour costs for welding and painting of bodies have to be added to this figure, the assembly plant labour costs’ share of the total production costs was in the vicinity of 5 percent. This means that even if labour costs in the assembly plant are reduced dramatically, the resulting total cost reduction will be marginal. The cost contribution of assembly plant man-hours is not sufficient to merit the amount of attention paid to them in MCW.

In a broader perspective, on the other hand, there are many significant elements of the total production costs that may have favoured Japanese automobile manufacturers. For example, (1) Japanese designers have apparently required less time and resources to design new car models, (2) Japanese manufacturers seem to have been able to obtain components more cheaply than Western manufacturers and (3) capital costs have been

low due to low interest rates and low inventory. Capital costs (as well as administrative overhead) have also been reduced by the high capacity utilisation attained in Japanese assembly plants.

Especially during the 1960s and 1970s, the main expansion period for the Japanese automobile industry, lower domestic wages, particularly among suppliers, created a cost advantage. In 1990, labour costs per hour in the Japanese motor industry were 90 percent of those in the United States, but as late as 1980 Japanese labour costs were only 58 percent of those in the US (Williams et al. 1992, p. 33). In 1989, Japanese motor industry firms with less than 100 employees – a category where the lower echelons of suppliers are found – paid wages equal to only 53 percent of those in the largest firms (ibid., p. 34).

Ironically, statistical data suggest that the productivity in the Japanese motor vehicle industry was lower than that in the United States at least until the mid-1970s (ibid., p. 18), so thesis (6) does not explain why the Japanese share of world automobile production increased from 1.3 percent in 1960 to 18.1 percent in 1975. Nor does thesis (6) explain why the Japanese share of world automobile production ceased to grow when assembly plant productivity reached the level of excellence reported in MCW.

5.2 Customer-perceived product value

As noted above, ‘product quality’ as defined in MCW is measured in terms of defects attributable to the assembly process, i.e. assembly quality. While assembly quality is one determinant of customer-perceived product value, it is hardly a major one, for several reasons.

First, the quality of the assembled automobile derives not only from the assembly process but also from the quality of the components assembled. Japanese automobile manufacturers have a reputation of demanding high quality from suppliers. How much component quality contributes to over-all product quality is an important question; unfortunately, it is not discussed in MCW.

Second, the customer-perceived product value depends not only on objective product features but also on how these features match customers’ needs and preferences. Originally, Japanese automobiles were designed to appeal to customers that wanted small and cheap cars, then dependability became an important selling point, and lately stylish appearance and ample equipment have characterised Japanese-designed automobiles. Whether Japanese automobile manufacturers have been particularly successful in designing cars that match customers’ needs and preferences during each period is another important question not discussed in MCW.

5.3 Market potential and market presence

Other important factors that affect market success are market potential, primarily the size and rate of growth of a market, and market presence, i.e. availability and customers' awareness of products. Japanese automobile manufacturers have certainly been fortunate to possess a domestic market with great potential and weak presence of foreign competitors.

The Japanese automobile market is today second only to the North American market, and 45 percent of all automobiles produced in Japan were sold on the domestic market in 1991. It may be argued that the growth of world market share for the Japanese auto industry in part only reflects the phenomenal growth of its sheltered domestic market. For example, the number of motor vehicles sold in Japan increased from some 200,000 in 1960 to about 7,000,000 in 1989.

The increased Japanese share of the world motor vehicle market of course also reflects an increased market share abroad. But again this successful market performance partly reflects market potential and market presences at home. In other words, profits generated at home but used for market investments abroad have contributed to the growth of market shares abroad (MCW, p. 208).

6. Conclusions

The main conclusion of my analysis may be stated in two parts:

- There do exist important differences between Japanese and Western automobile manufacturers with regard to economic success, product quality, productivity and assembly plant practice. These differences are, however, somewhat exaggerated and distorted in MCW. (They are even more exaggerated and distorted in the general debate on lean production.)
- Contrary to what is implied in MCW, the 'lean production' assembly plant practice does not have a decisive influence on assembly quality and assembly plant productivity; there are many other important contributing factors. Moreover, assembly quality and assembly plant productivity do not have a decisive influence on economic success (even if economic success is narrowly defined in terms of market performance); there are many other important contributing factors.

The last point can be clarified by comparing the simple causal model in figure 1 with the amended model in figure 3.

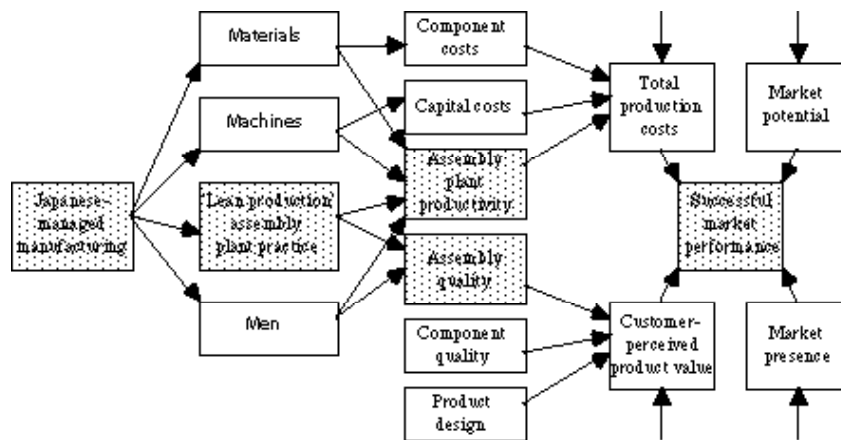

Figure 3. An amended version of the original causal model (the shaded boxes are those included in figure 1)

From a scientific point of view, the oversimplified message about the virtues of lean production presented in MCW must be questioned and criticised in several respects. The presupposition that the factors that explain productivity, product quality and market performance today did also explain them 25 years ago is historically naive. Procedures for measuring productivity and quality are incompletely documented, the validity and reliability of the measures is questionable, and the concepts measured have minor relevance. The causal interpretation of observed correlations is methodologically naive.

But it would also be naive to assume that the book's impact outside the scientific community is determined by its level of scientific rigour and methodological sophistication. The big and difficult decisions facing managers in the automobile industry today are potentially anxiety-arousing. Simple, forcefully stated diagnoses and prescriptions that relieve anxiety have great appeal in this situation, whereas a scientifically solid, carefully qualified analysis may fail to impress decision makers.

Unfortunately, MCW's analysis of the Volvo Uddevalla and Kalmar plants seems to have been affected by this logic of persuasion. The Uddevalla plant is dismissed as 'neocraftsmanship ... almost certain to be uncompetitive with mass production, much less lean production' with neither any empirical data nor any understanding of its mode of operation to support this conclusion. Elaborating on the 'neocraftsmanship' interpretation, the authors speculate that '[t]he real satisfaction presumably comes in reworking and adjusting every little part so that it fits properly' (MCW, p. 102), as if standardised, interchangeable parts were not used in the Uddevalla plant! The Kalmar plant is also misrepresented: the statement that it 'reintroduced craft techniques by giving small groups of workers responsibility for assembling a whole vehicle' (MCW, p. 47) is false. While a more careful assessment of

the Uddevalla and Kalmar plants would have made the message about lean production as the ultimate manufacturing method less compelling, it would simultaneously have made the story told more interesting and credible.

References

- Armstrong, L. (1991), 'Who's the most pampered motorist of all?', *Business Week*, June 17.
- Berggren, C., T. Björkman, and E. Hollander (1991), *Är dom oslagbara?*, Institutionen för Arbetsvetenskap, Kungliga Tekniska Högskolan, Stockholm.
- Engström, T. (1983), *Materialflödessystem och serieproduktion*, Chalmers University of Technology, Göteborg.
- Ellegård, K., T. Engström, B. Johansson, M. I. Johansson, D. Jonsson, and L. Medbo (1992), 'Reflective Production in the Final Assembly of Motor Vehicles – An Emerging Swedish Challenge', *International Journal of Operations & Production Management*, vol. 12, no. 7/8: 117–133.
- Fucini, J. and S. Fucini (1990), *Working for the Japanese*, Free Press, New York.
- Helling, J. (1991), *Världsmästarna. En ny generation av tillverkningsföretag*, Selin & Partners, Stockholm.
- Womack, J.P., D. Jones, and D. Roos (1990), *The Machine that Changed the World*, Rawson Associates and MacMillan International, New York.
- Krafcik, J.F. (1987), *Trends in International Automotive Assembly Practice*, The International Motor Vehicle Program.
- (1988), *Comparative Analysis of Performance Indicators at World Auto Assembly Plants*, Sloan School of Management, MIT, Cambridge, Mass.
- Löf, H. (1991), 'Klarar Svensk bilindustri den japanska utmaningen?', *Fakta/Debatt*, no. 4, TCO, Stockholm.
- Williams, K., C. Haslam, J. Williams, T. Cutler, A. Adcroft and S. Johal (1992), 'Against Lean Production', *Economy and Society*, August.

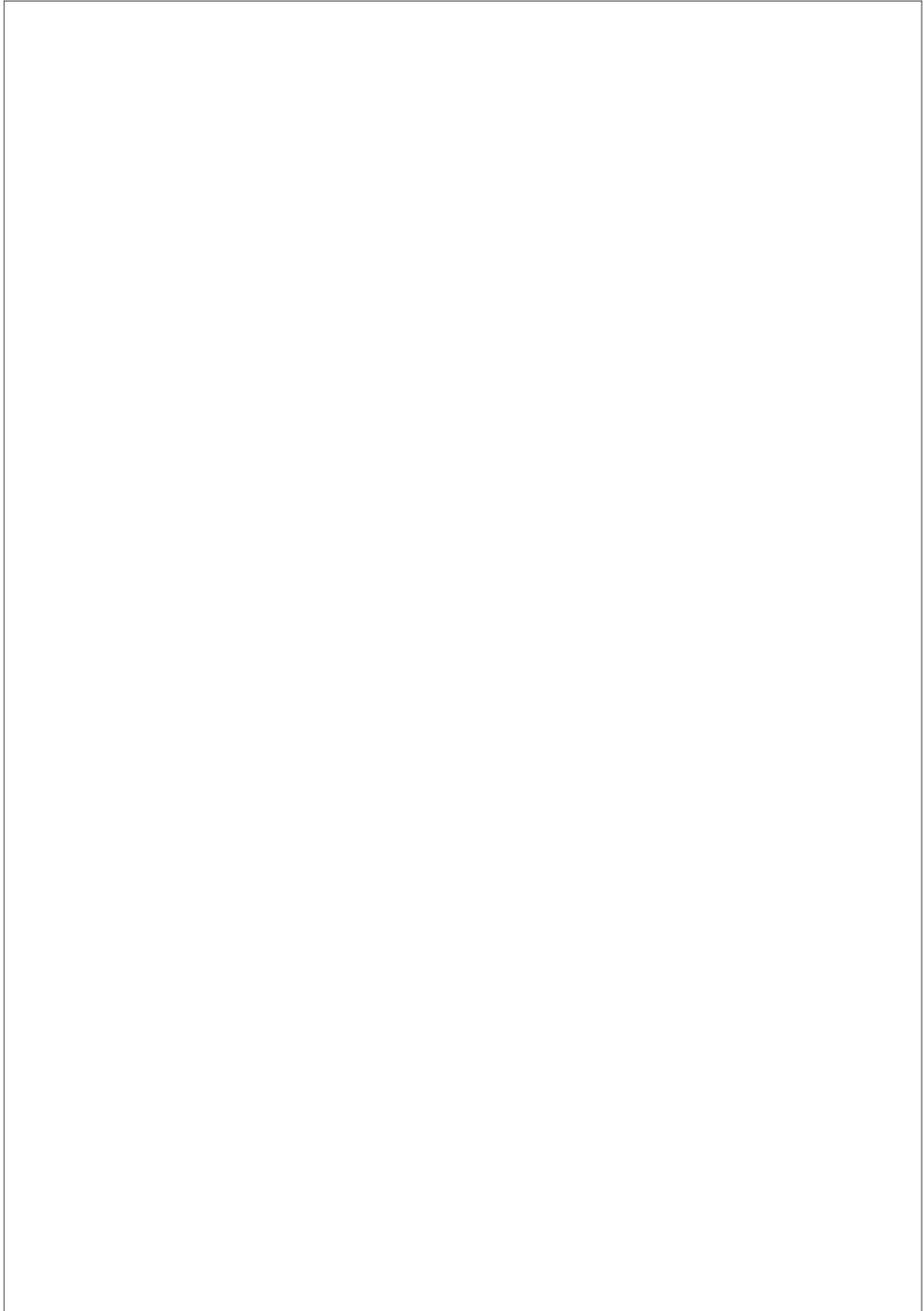

Humanization of the production system and work at Toyota Motor Co and Toyota Motor Kyushu¹

Koichi Shimizu

In the mid 1990s, when it appears that 'lean production' is being adopted by all automobile producers, Toyota has been reorganizing the very production system upon which 'lean production' is based.

After encountering a crisis of work during the late 1980s in the midst of Japan's 'bubble economy', the management and the union at Toyota began to question the production system and the social relations of work in search of a radical way to tackle the problem of work that had been posed. The conclusion was that the principle of 'just-in-time' should not be applied to people. In modifying the organizational principles of production (just-in-time and autonomization, the latter meaning that machines switch themselves off automatically when a problem arises) and the management of work, and in developing a new conception of the assembly line and of team working, Toyota decided to humanize its production system to enrich work, thereby making work more attractive. It is clear that Toyota wants to create a *new Toyotaism*, far removed from the 'factory of despair' image presented by Satoshi Kamata in the early 1970s.

And yet, radical as it is, reorganization at Toyota is still influenced by the old Toyotaism. The new assembly line has only been installed at the fourth factory at Tahara. Moreover, it remains difficult for Toyota to make a clean break with its previous method of managing work, especially since this proved so effective as a means to mobilize and develop its human resources. On the other hand, the experiments currently being undertaken at Toyota Motor Kyushu, the new Toyota subsidiary in Kyushu, suggest a clean break with the old Toyotaism as far as the management of work is concerned. At this factory, a different concrete expression of the new Toyotaism can be observed, one which appears to reveal the future of Toyota.

In this chapter we will discuss the following points:

1. The crisis of work and its causes, which led Toyota to question its production system and its social relations of work.

2. The problems of crisis of work that the management and the union discussed during 1990–1992, and the measures they decided to adopt.
3. The new assembly line and social relations of work that can be observed at Toyota Motor Kyushu.

1. The crisis of work and its causes

For the Japanese automobile producers, the crisis of work emerged during the ‘bubble economy’ period, especially around 1990. It was already latent, since there were external and internal causes already leading to a shortage of labour. Then the overheating of demand due to the ‘financial bubble’ played a catalytic role in the appearance of a crisis of work.²

In the first place, the labour market had become increasingly tighter, so much so that Toyota and the other automobile producers were faced with a problem of recruitment by the end of the 1980s. This was due in part to the shrinking of the working population, due in turn to the lower birth rate. It was also in part due to the fact that young high-school leavers who constituted the labour force for Japanese industry were tending to avoid jobs characterized by the ‘3 Ks’ (Kitanai, or dirty; Kitsui, or difficult; Kiken, or dangerous), and were looking for employment in the service sector.

In the second place, the rate of turnover amongst young production workers was high in the automobile industry because of the very nature of work on the assembly line, which was fragmented, monotonous, and repetitive. Even if recruitment targets were being met, the high turnover rate was threatening to cause a shortage of labour. If that happened, production workers would be obliged to work long hours of overtime, all the more so as output was growing rapidly.

In the third place, and finally, the ‘financial bubble’ appeared to overheat the automobile market. Not only did output increase rapidly, but purchasers wanted top-of-the-range cars and a wide variety of choice. The producers were already tending to diversify their product range and increase the variety of their models, and the ‘bubble economy’ accelerated this tendency. Yet the Japanese automobile producers did not possess sufficient capacity to respond fast enough, partly because they were unable to hire enough labour (due to the labour shortage), and partly because they had been trying to introduce a ‘lean production’ system since the first oil crisis in the early 1970s. Accordingly, their employees (not just production workers but also engineers) were so overloaded that lead-times and replacement cycles had lengthened. While the producers were able to resort to the employment of temporary employees on a massive scale to reduce the labour shortage, this only led to a reduction of productive efficiency, since the temporary employees did not possess the abilities that were necessary even though

their salaries were very high compared to other employees of their age. Obligated thus to work long hours, employees became exhausted, and found themselves not so much paid considering their extra work load. There arose a certain disaffectedness amongst the hard core of the work force towards assembly line work.

The crisis of work which thus emerged found its root causes in structural change in the labour market, the nature of assembly line work, and Japanese-style 'lean production'. The behaviours of the automobile producers when confronted with this crisis of work were not, however, identical. Some producers decided to construct highly automated factories, such as the second Nissan factory in Kyushu in 1992, and the Mazda factory at Hofu in 1992. During this period Toyota also constructed its fourth factory at Tahara, opened in October 1991, which manufactures top-of-the-range Toyota models (Celsior, Lexus LS400, Crown-Majesta and Aristo GS300) on two assembly lines. However, Toyota put into practice a new conception of the assembly line, because it recognized that the cause of the crisis of work lay in its production system and its method of managing work.

The Toyota production system tended to intensify work, because it managed productive efficiency in a way that was closely linked to the salary system.³ As the term 'lean' indicates, the objective of the Toyota production system was to reduce production costs. 'Just-in-time' production was one means (production *without stocks*), but management also managed costs scrupulously, especially variable costs, from upstream to downstream. As far as labour costs were concerned, its method of managing productive efficiency had as its goal the reduction of production times (Ko-Su-Teigen) and the number of production workers (Sho-Jin-Ka) through the mobilization of employees towards improvement (Kaizen) of production tasks and procedures. This management method was based upon *payment for production*.

Payment for production, which accounted for about 60 percent of the standard salary in the late 1980s, was the product of the basic salary and the coefficient of production remuneration (CPR). While the calculation of the CPR for each shift is complex, the factors included are the real time of production, the volume of production, and the standard time. In principle, a reduction in the real time of production and an increase in production volume have a positive impact on payment, and a reduction of standard time has a negative impact. In this system, it is necessary to reduce the real time of production in order to increase productive efficiency, and thereby payment for production, with a given standard time and production volume.

The management of productive efficiency is therefore focused on the real time of production (which is the product of working time and the number of production workers), and the standard time (which is the point of reference for measuring productive efficiency).⁴ In monitoring changes in the

productive efficiency of each shift, management imposes the factories to reduce the standard time and the number of production workers, and these become the norms for Kaizen activities. Thus a Kaizen-productivity-salary chain is established.

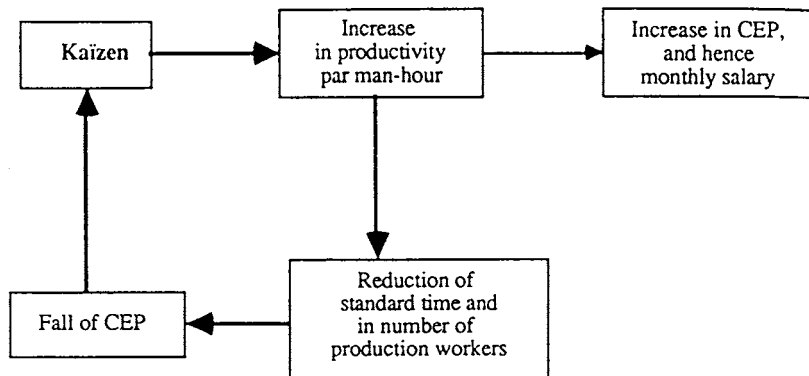

Figure 1. The relationship between kaizen, productivity and salary

Through Kaizen activities, the productive efficiency of each shift is increased, so that its coefficient of productive efficiency (CEP) rises, which in turn brings higher payment for production. Once the CEP has passed a certain threshold, the standard time and the number of production workers in each shift will be reduced, and as a result its productive efficiency will be lowered since it has to function with fewer production workers. Each shift, or rather the section which manages this shift (a section manages two alternating shifts) will then attempt to increase its productive efficiency through Kaizen activities on production tasks and procedures, so as to increase its CEP.

This mechanism was able to function well over nearly forty years to increase productivity and contain the growth in numbers of production workers because the following conditions were fulfilled:

1. Stable social relations of work based upon mutual trust between employer and union (employees beneath section leaders are all unionized).⁵
2. Adequate training for supervisors in Kaizen activities, including methods of determining the standard task and the standard time.⁶
3. Creation of sound human relations in the factory, so that everybody participates in, or at least accepts, Kaizen (this is also one of the functions of supervisors).

4. The principle of sharing the benefits of Kaizen activities (system of payment for production); etc.

However, the outcome of this management system was that the factories worked with the minimum number of production workers and at a very fast pace. Their Kaizen activities led them to work increasingly faster and harder. This method of managing work can be interpreted as the application of 'just-in-time production' principles to people. During the era of stable economic growth, the Toyota production system, managed according to this method, functioned so well that it was considered to be a model for post-Fordism. Not surprisingly, it provoked a high rate of turnover amongst younger workers, especially in the assembly factories.⁷ Nonetheless, a labour force could be assured, one way or another, until the second half of the 1980s.

The 'bubble economy' hit the Toyota production system hard, bringing the labour shortage to the surface. Having become too 'lean', and experiencing recruitment difficulties, the production system was unable to respond to growing demand for products. To counter the labour shortage, Toyota hired temporary employees on a massive scale from 1987, so that they accounted for 11.59 percent of production workers in 1991, the apogee of the 'bubble economy'.

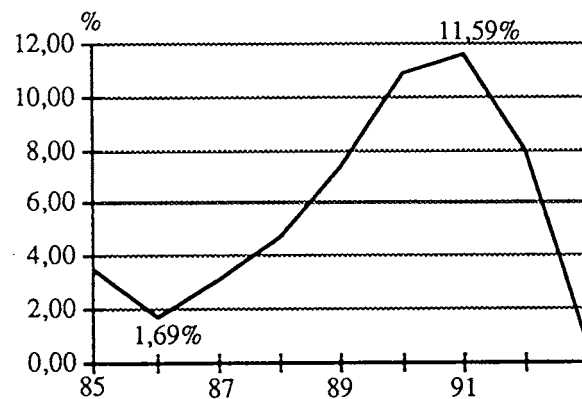

Figure 2. Proportion of production workers who are temporary employees

Source: Toyota, Personnel Management Departement

Despite this policy, the crisis of work in the form of a shortage of labour could not be resolved. The massive entry of temporary employees with in-adequate abilities disturbed the organization of work, not to mention lowering productive efficiency. In the worst cases, there were groups of

workers (Kumi) of whom two thirds were temporary employees (according to the personnel management department). This forced their supervisors to work on the assembly line to help them rather than undertake their own functions. The result was increased overtime. Annual working hours in the production department increased from 2,224 hours in 1987 to 2,315 hours in 1990. Thus the labour shortage crisis was transformed into a crisis for the whole work force: the hard core of employees, including supervisors, were exhausted.

Facing up to the labour shortage and to the exhaustion of the whole work force, the management and the union at Toyota began to question the production system and the method of managing work. They concluded that a radical resolution of the crisis of work could only be found in a reorganization of the production system to make work more attractive, for they were in agreement that the cause of the labour shortage was the nature of assembly line work and the Toyotaist method of managing work.

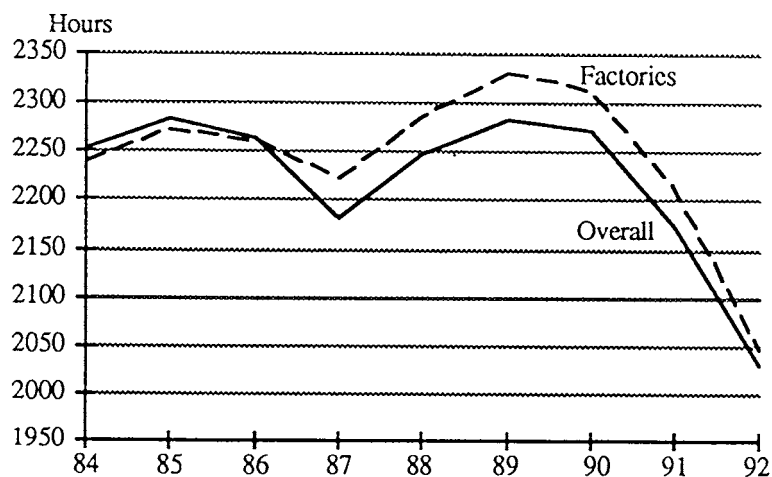

Figure 3. Hours worked per year
Source: Toyota, Personnel Management Department

2. The questioning, and the outlines of a new Toyotaism

In June 1990, in the midst of the crisis of work, union and management set up a committee to discuss ways to make factory work more attractive. Between 1990 and 1992, the committee discussed several problems which reached right to the heart of Toyotaism: 1) the management of productive

efficiency linked to the salary system, in particular to payment for production; 2) personnel management methods to do with promotion, training and abilities; 3) uncomfortable working conditions that prevented older people or women from working; 4) the assembly line work in the assembly factories that lay at the root of the high turnover rate amongst younger employees.

Modifying the management of productive efficiency

Regarding the payment system and the management of costs, the committee questioned the method of managing costs, the system for evaluating productive efficiency, and the determination of the standard time. The central problem in managing costs lay in the fact that it was too focused on the management of productive efficiency, unilaterally imposing the norm for Kaizen activities on the factories. What was needed, therefore, was to make it appear more rational to employees.

As has just been explained, the basis for the management of efficiency lay in the reduction of the number of workers, which was accomplished by Kaizen activities on production tasks and procedures. This in turn was based upon the ideas of 'just-in-time' and 'autonomization' (labour saving) which had been sustained and developed by T. Ohno. But the underlying cause of the crisis of work that Toyota was experiencing was precisely this system for managing productive efficiency. Therefore the idea of 'just-in-time' was questioned. 'Just-in-time should not be applied to people', according to a section leader at the Motomachi factory. 'If the number of production workers is increased, productive efficiency will be lowered. But we should not think solely about productive efficiency', according to the personnel management department. The implication is that the reduction in the number of production workers should not be pushed too far. In other words, 'lean production' should not be applied to production workers. Otherwise, work will continue to be detested by the younger generation and will continue to tire production workers and supervisors. Hence the committee proposed to modify the management of costs.

The practice had been to set labour cost objectives when a model was launched or updated, according to the best costs obtained in the past, while the cost of raw materials was set by estimates. To resolve this contradiction, the cost goal would now be set according to results achieved three months after model launch. Moreover, management had imposed the Kaizen norm uniformly, without taking the characteristics of the factories into consideration. Henceforth, management would set Kaizen objectives taking into account objectives that the factories set for themselves voluntarily. Moreover, Kaizen objectives would be set for a year, instead of six months, since with six-month periods it was difficult to undertake Kaizen activities with long term impacts.⁸ Simultaneously, management promised to focus more on

trying to reduce the costs of raw materials, parts and components instead of compelling the factories to increase their productive efficiency. As a result, cost planning during the design phase becomes a more important way of lowering costs. Simply put, management has renounced its authoritarian and unilateral power to manage costs, and above all productive efficiency, and has given the factories autonomy in the pursuit of Kaizen activities. With this autonomy, however, comes more responsibility.

At the same time, the system of payment for production as a tool for managing productive efficiency has been made more rational. Under the old system, the coefficient of production remuneration (CPR) for the direct section was calculated according to a classification of every shift together. However, the productive efficiency of the more automated factories tends to be higher than that of the less automated factories such as assembly factories. To correct this imbalance, the calculation of the CPE is to be undertaken according to groups of homogeneous factories: a group for foundries, forges, stamping and sheet metal plants; a group for mechanical components; a group for body construction, painting and plastic moulding; and an assembly group. Henceforth, management is to evaluate the productive efficiency and the Kaizen efforts of each shift by group, taking the characteristics of the factories into account. Furthermore, management has reorganized direct and indirect sections to enable the factory as a whole can improve its productive efficiency. The two sections are thus regrouped into a single section 'P' (plant).⁹ Now the productive efficiency of the whole factory is to be evaluated rather than that of the direct section. Accordingly, cooperation between the two sections has become more important.

Regarding the management of working time, in other words the number of production workers and the working hours per person, several modifications have been made. For the standard time in the assembly factories, only the time required to attach parts to the automobile body had been measured, but management now allows other factors to be taken into consideration, to make the process seem reasonable in the eyes of the production workers. Tasks undertaken by older or female production workers can also be taken into account in determining standard times. Moreover, with the lengthening of the initial training period, and the establishment of a new vocational training scheme (see below), employees who are taking part in them are excluded from the CPE calculation during their off-the-job training (their salary is of course still paid), for as long as their training lasts. Finally in respect of the management of working time, management and union are recommending to employees that they take all their paid holidays, so that the planned reduction in annual working hours is met.¹⁰ Simply put, the management of standard time and the length of working time have become less of a constraint and appear more reasonable to employees.

Questioning personnel management: training and hierarchical position

In the area of personnel management there have been a number of modifications: initial training aimed at reducing the high rate of turnover amongst new recruits; a new vocational training scheme to broaden the abilities of production workers; a reorganization of the hierarchical positions of supervisors; and changes to the system of obligatory renunciation of the functions for which a person is responsible at the age of 55.

To resolve the problem of the rate of turnover amongst new recruits, which reached 25 percent for the first time in 1990, in 1993 Toyota made modifications to their initial training. Formerly, new recruits were assigned to the factories as production workers after two weeks of training at company headquarters. Management has now eliminated this training and devolved it to the factories, at the same time making it longer: nine weeks in the stamping, sheet metal, body and assembly factories, six weeks in the others.¹¹ Generally speaking, the factory gives new recruits two weeks of general training, then assigns them to their work area where they receive on-the-job training whilst undertaking half the tasks of production workers and rotating to different posts within the work area. Their first post will then be determined after training. It is too early to evaluate the results, but the prolongation of initial training appears to be having a favourable impact in reducing the rate of turnover. In the assembly factories, the rate of turnover has been reduced by 9 percent. The same effect can be seen in the factories which spread training over nine months, while turnover in the other factories has increased by 5 percent.

For production workers, the new vocational training scheme was introduced in February 1991. Management allocates production workers to four levels (C, B, A and S) of vocational competence, according to the results of a test given after they have received off-the-job training followed by on-the-job training. For production workers in the direct section, there are 40 hours of off-the-job training for candidates at each level. For maintenance technicians, there are 280 hours of training for candidates at level C, 360 hours at level B, and 460 hours at level A (there is not yet a level S). As an example, the case of production workers in assembly areas at the Motomachi factory can be examined. A level C production worker is able to undertake two or three tasks with a minimum seniority of two years; a person at level B is able to undertake tasks extending beyond those of his work team (Han), including repair, with a minimum seniority of five years; a person at level A is able to undertake tasks extending beyond those of his work group (Kumi), with a minimum seniority of ten years; finally, a person at level S, with more than fifteen years seniority, should be able to undertake every task in the assembly area, in other words be able to assemble a whole car by himself. In this way task rotation too is made systematic as a means of

implementing the new training. Toyota has adopted this training scheme for the following reasons:

1. The need to systematize abilities training for production workers which had previously been included in on-the-job training.
2. The need to broaden the skills and knowledge of production workers who only knew how to undertake limited tasks: there were no production workers who knew every task in their area (for instance, an operator in the stamping area might have known how to change dies better than his western counterpart, but he did not understand all the tasks involved in stamping).
3. The need to give opportunities for vocational training to production workers who could not be promoted to supervisory posts where they would have received increasing training as they attained higher grades.
4. The need to give production workers training which would enable them to enjoy their work.

Thus, the goal of the new training is to give production workers 'enjoyment at work' through greater recognition of their know-how concerning their work. While Toyota does not intend to introduce the Uddevalla model, there are certain resonances with this model. Certainly, the new vocational training scheme has been much welcomed by employees in the production department.

Toyota has also introduced minor modifications to the structure of hierarchical positions and employee careers. As a result of mechanization and automation in areas outside assembly, during the 1980s there was an increase in the number of team leaders (Han-cho) without any subordinates, and in the number of group leaders (Kumi-cho) and sub-section leaders (Ko-cho) with few subordinates. To be a supervisor with no subordinates was demoralizing. Since at Toyota salary increases have traditionally been linked to hierarchical position-rank-post, the posts could not be eliminated. So Toyota has changed their status, respectively to expert (EX), senior expert (SX) and chief expert (CX), retaining the hierarchical position-rank that they had occupied. Henceforth, team leaders, group leaders and sub-section leaders are only to be found in assembly areas.

The system of obligatory renunciation of the functions for which a person is responsible at age 55 has also been revised. The system has not been abandoned, but supervisors considered to have the required abilities and who wish to remain can continue to undertake their functions until they are 60, the age of retirement. Between March 1991 and August 1992, 60 percent of sub-section leaders concerned kept their posts, though only 12 percent of team leaders and group leaders kept theirs. Moreover, after the age of 55,

Table 1:
 Holders of vocational training certification, December 1st 1993.

<i>Factories</i>	<i>Persons</i>		
	<i>Level A</i>	<i>Level B</i>	<i>Level C</i>
Headquarters		239	239
Motomachi		602	448
Kamigo		231	214
Takaoka		718	465
Miyoshi		145	81
Tsutsumi	9	732	711
Myochi		78	93
Shimoyama		166	108
Kinuura		93	165
Tahara		1,096	875
Others		750	1,156
Total		4,850	4,555

Source: Toyota: Personnel Management Department

the same salary increases as for other employees are guaranteed, whereas they had been only half the average increase since 1982 (and had been zero prior to 1982). This of course is designed to provide a source of motivation for employees over 55 years old.

Improving working conditions, and a new concept for the assembly line

The committee decided to make investments to render the production system more humane and therefore make work more attractive. In fact, during the current long recessionary period, management has not reduced investments which are designed to improve the work place, even if investment in new capacity has been reduced. Symbolically speaking, the aim of this investment is to make the work place fit for older and female production workers: 'If older workers are unable to work there, it is the factory which is bad. It must therefore be changed so that they are able to work there' (the director of the production design department). The assembly factories are examined below, since that is where Toyota encountered the crisis of work.

As far as the assembly line is concerned, the first step was taken at the Tsutsumi factory. The first of the final assembly lines was selected to be a model line. By dividing the line, which is more than a kilometre long, into four zones, and installing separate lines to prepare sub-assemblies (doors, engines, seats¹²), the factory is now able to maintain buffer stocks between the zones and between the assembly line and the preparation lines. The

Table 2: Numbers of Supervisors and Experts in 1993

<i>Hierarchical Rank</i>	<i>Supervisors</i>	<i>Experts</i>	<i>Total</i>
Senior Group Leader	Kocho 1,400	CX 320	1,720
Group Leader	Kumicho 3,920	SX 1,100	5,020
Team Leader	Hancho 1,930	EX 9,580	11,510
Direct Workers			22,220

Source: Toyota, Personnel Management Department

rationale is that it was believed that all the problems related to work were due to zero-stock production, or the rigid 'just-in-time' principle established by T. Ohno. This minor modification to an old factory is already being welcomed by the production workers. With buffer stocks, the work pace can be adjusted by line segment, so that the workers can even finish their allotted output before the set time (albeit only 10–15 minutes) while work on the adjacent, traditional assembly line continues.

Management is currently investing 500 million yen to modify the traditional assembly lines, 200 million yen to improve their working environments (mini-conveyors, lighting, etc.) and 1.1 billion yen to modify their processes (automation of the most arduous tasks, etc.).

However, the real innovation in the design of the final assembly line was created by the third division of the production technology department for the construction of the fourth Tahara factory.¹³ The assembly line is divided into a dozen mini-lines, and it is possible to keep buffer stocks between them. With wide rectangular platforms linked together in place of the normal conveyor, production workers are able to undertake their task while remaining on the platform and not having to walk along. Moreover, automation has been pushed as far as possible to eliminate tasks which are considered arduous from an ergonomic viewpoint (the level of arduousness of tasks has been quantified), and to resolve the labour shortage problem. With stocks between the mini-lines, which was considered wrong by T. Ohno, each mini-line now possesses a relative autonomy and independence in terms of the management of production. Productive efficiency has been increased, since if one mini-line has to be stopped because of a certain problem, the other lines continue production, and the line affected can catch them up later by increasing its work pace.

In terms of team work, four production workers form a work team which is responsible for a segment composed of a series of connected tasks (three or four tasks). The work team takes responsibility for the quality of its tasks, whereas on traditional lines, each person is responsible individually. Finally, some of the final quality control tasks have been transferred to the mini-lines ('in-line control': seven of the lines have a quality control post, and each has a rework post).

Thus the fourth Tahara factory, which is called a 'factory for the man as "principal actor"' was developed in order to bury the image of the 'factory of despair', in the words of its vice-manager. This new concept of the assembly line was to be developed even further in the construction of the Toyota Motor Kyushu factory.

But it remains difficult to make a clean break with the old Toyotaism

Simply put, Toyota is undertaking a humanization of its production system. But does the current reorganization spell a clean break with the old Toyotaism? It appears that Toyota's goal is to give a more humane dimension to its production system and to its management methods. However, this does not imply that Toyota is throwing away everything that has been created in the past on the basis of the two ideas of 'just-in-time' and 'autonomization'. What Toyota is doing currently is to correct the way these ideas are put into practice to make them more reasonable from the human viewpoint. Moreover, it is difficult for Toyota to make a clean break with the old Toyotaism. Without going into detail, the recent alterations to the salary system can be examined to show how difficult it is for the company to make a clean break with the past.

In April 1993 Toyota adopted a new salary system. The old salary system had already been modified in April 1990, with the introduction of payments corresponding to age and hierarchical position, each weighted at 10 percent of the standard salary. Correspondingly, the weight of the payment for production was reduced from 60 to 40 percent, with the remaining 40 percent accounted for by the basic salary. However, the method of calculating the payment for production was not changed by these reforms. Moreover, a single system continued to be applied to all personnel. By contrast, in the new system, Toyota does not include payment for production in calculations for white collar employees and engineers (only employees in the Plant and Engineering sections now receive payment for production, which has been renamed 'payment proportional to productivity'). Further, not only is the weight of this element in the salary reduced from 40 percent to 20 percent (the shares of payment accounted for by age and hierarchical position in the average standard salary now being 20 percent each), but the calculation method has also been modified: the CPR is no longer multiplied by the basic salary, but is applied to a payment grid linked to hierarchical position.

Hence payment for production is retained, under the pretext that its effect is to encourage production department employees to participate in Kaizen activities: it represents the salary system, in the sense that one is paid more to the extent that one puts effort into Kaizen activities aimed at increasing productive efficiency. This was precisely the goal of T. Ohno when he introduced it at the start of the 1950s. While there has been a certain radical

reorganization of cost management and of the production system, Toyota remains a captive of its past. At Toyota Motor Kyushu, however, an entirely new system for managing work has been introduced.

3. A new Toyotaism at Toyota Motor Kyushu

Toyota Motor Kyushu is a subsidiary of Toyota which started production of the Mark II model in December 1992. Its relationship with Toyota is parallel to that of Saturn with General Motors. Toyota Motor Kyushu, in other words, undertakes experiments that would be audacious for Toyota, which finds it difficult to sever its links with the past. What is most remarkable is that Toyota Motor Kyushu has not adopted the payment for production system, which means that it no longer manages productive efficiency in the same way as Toyota, and that employees are encouraged to undertake Kaizen activities by other means. In fact, there is not a policy of reducing the number of production workers in order to increase productive efficiency. Moreover, in further developing the concept behind the assembly line at the fourth Tahara factory, Toyota is giving team work a new dimension.

Salary and incentive

The salary system is very simple (the figures in parentheses are proportions of the average salary): Monthly salary = basic salary (60%) + salary related to hierarchical position (40)%

Since employees work in two successive shifts (6:00–14:50 and 15:05–23:55) without overtime, there is no overtime payment. The basic salary is determined by the Satei (evaluation), but mainly follows seniority and the cost of living, and is revised each April. The part corresponding to hierarchical position is basically determined by the hierarchical position of employees, which is revised by Satei three years and five years after recruitment, then every two years. It is also revised each April, following the results of Satei and of negotiations between management and the union.

In the place of payment for production as a mean of giving incentives to workers, Toyota Motor Kyushu has introduced a new system called the 'Performance Incentive of Toyota Motor Kyushu' (PIT) to encourage employees to produce, and to encourage Kaizen activities bearing upon costs, quality, and safety. This is done in order to stimulate an emulation between the sections (Ka) with the purpose of reducing the costs and assuring the quality. The evaluation of these activities is then reflected in an increase in the size of the bonus. For the first of these, the sum paid per employee amounted to 50,000 yen for the first six months of 1994.

These new systems have been introduced to avoid the negative effects of the payment for production system:

The effect of the payment for production system is to push the work teams to increase their productivity. But if they are pushed too much, there will be negative impacts rather than positive impacts. (Quality control sub-section leader)

When we were discussing the problem of work at Toyota, the major problems were payment for production, which was suffocating us, and the principle of zero-stock production which forced supervisors to work on the assembly line and prevented them from undertaking their own functions. (Member of the general affairs department, former member of the executive committee of the Toyota union)

Thus, Toyota Motor Kyushu is trying to adopt a new incentive system through a new salary system, even as the management of Toyota does not dare to make a clean break with the system established by T. Ohno.

A new production system and a new way of working

The new assembly line at Toyota Motor Kyushu is a further development of the assembly lines of the fourth Tahara factory, but with less advanced automation, since in Kyushu the third division of the production technology department has concentrated upon technologies for semi-automation, taking into account profitability and the quality of the man-machine relationship. The new characteristics of this line are as follows (see Figure 4):

1. The platforms used (the same ones as at the fourth Tahara factory) are equipped with a base that can be adjusted for height, depending upon the height of the worker, so that production workers do not have to work in a difficult posture.
2. A working group is responsible for a mini-line, each of which has a quality control post so that the group can assure the quality of its products.
3. Moreover, with three car bodies before and after the mini-line, the group leader can regulate the work pace of his group; hence the organization of the work done by his group is based in his own abilities, whereas traditionally at Toyota it was based upon the abilities of the Kacho (section leader).
4. In this way more autonomy and more responsibility are devolved to the working group; the group can hold a 5 minute meeting in order to solve a problem or to make a Kaizen activity, by accelerating its work pace and accumulating 3 to 5 car bodies at the end of its mini-line.
5. Moreover, the assembly line is more efficient than the traditional line, since if one mini-line stops due to a problem, the others continue to function and the line affected can catch them up by accelerating its pace of work.

While Toyota Motor Kyushu has not abandoned the principles of 'just-in-time', which are supposedly being respected, it has relaxed the constraints imposed by T. Ohno in order to put in practice a more humane production system. In simple terms, the principle of 'just-in-time' is not being applied to people, while the idea of 'autonomization' *is* now being applied to people, and especially to so-called 'team work'.

As far as 'team work' is concerned, it is the group leader who organizes the task rotation in his group, taking into account the skill level of his workers. Through the task rotation a worker now learns all tasks in his group to become a professional worker in this segment. He can also move to another work group after having learned all tasks in his original group, in so far as he wishes to obtain a wider skill, and if his leader permits it. The groups in the assembly area include at least one woman, who receives the same salary as men of the same age, at least to start with (salaries will later vary, not by gender, but due to hierarchial position and Satei). This is possible because the factory has become an acceptable place even for young women to work.

Moreover, Kaizen and suggestion activities too are undertaken by workers and work groups. The suggestion system was introduced in August 1993. Even though at Toyota the number of suggestions per person exceeds 20 per year, most of them only constitute 'simple ideas'. At Toyota Motor Kyushu, by contrast, the worker has to spell out his idea in concrete form before presenting it as a suggestion. The QC circle activities are being launched in July 1994. A work group constitutes a QC circle with the task of solving the problems that occur in this group. To organize the activities for Kaizen, the work group holds a meeting, either after work in order to observe the tasks performed by the other shift, or during work, after having stopped the line, for 5 minutes in the case of an assembly area. The group leader is authorized to stop his mini-line whenever he wants, as long as the tasks of the other segments are not disrupted. This is possible since there is a buffer between the mini-lines. For the QC circle activities, each group sets up its own Kaizen goal proposed by its members, in general for a period of six months. After the sub-section leader, on the basis of his experience,¹⁴ has approved or modified the goal, it is approved by the section leader, who is authorized to make such decisions in the factory. Six months later the section leaders and the sub-section leaders jointly evaluate the degree to which the goals have been achieved. These activities are treated as a task, and the result of the activities will be reflected in the evaluation of the section's activities, and subsequently in the size of bonus (cf. PIT mentioned above). As things stand currently, Kaizen activities appear also to constitute human relations activities. Members of the group can reinforce their ties in discussing a subject proposed by group members. This is all the more important since Toyota Motor Kyushu does not intend to introduce the same full human

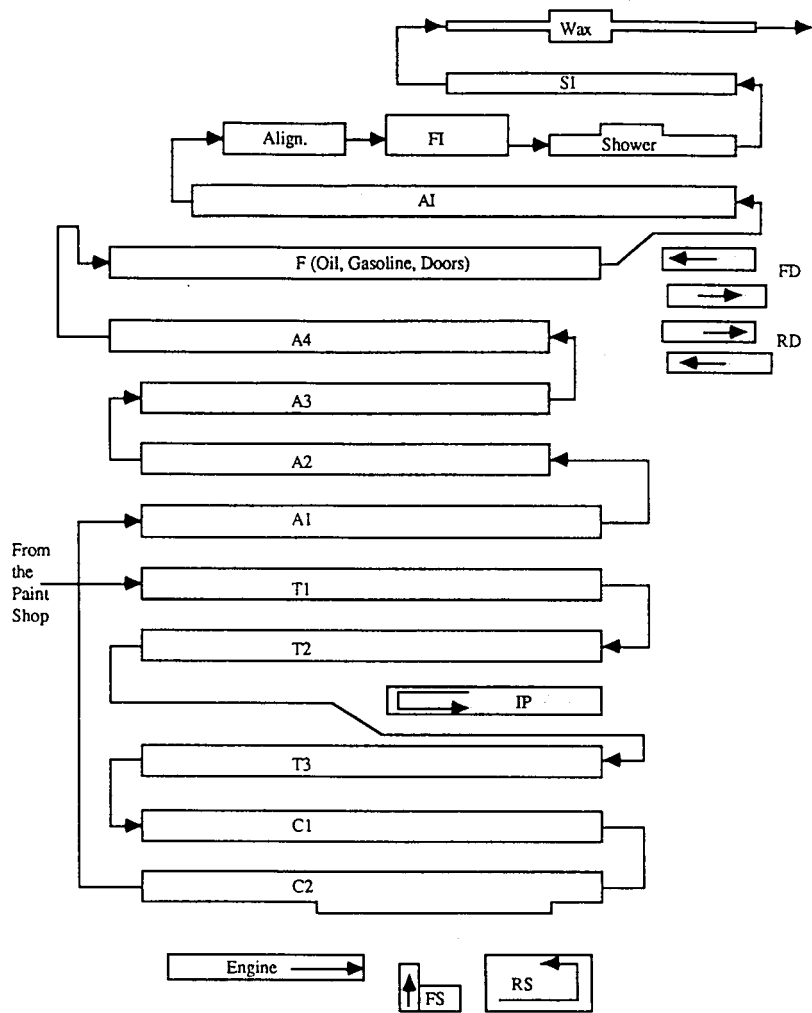

A : Assembly ; T : Trim ; C : Chassis ; F : Final Line ; AI : Assembly Inspection ;
 Align. : Alignment ; FI : Functional Inspection ; SI : Shipping Inspection ; FD/RD :
 Sub-line for Front and Rear Doors Assembly ; IP : Sub-line for Instrument Panel
 Assembly ; Engine : Sub-line for Engine Preparation ; FS/RS : Sub-line for Front and
 Rear Suspension.

Figure 4. The assembly line at Toyota Motor Kyushu where the Mark II model is made

relations activities as at Toyota.¹⁵ If it is to undertake human relations activities, these are only to be within the factory and above all within the work group. Hence it is possible to avoid suffocating the entire life of the employees. What matters is to create a work place that is more humane and attractive for all employees.

In conclusion

With the depth of the current recession, the crisis of work would appear to be over. Surely Japanese companies are now talking in terms of overmanning and redundancies? Surely, sub-contractors which employ foreign workers are sending all or most of them back to their own countries? Is unemployment not disciplining Japanese employees? Certainly it is possible to observe signs of this. For this reason we do need to test Toyota's seriousness. During the period of crisis of work, only Toyota dared to question its production system and its method of managing work, which were functioning so well that they were considered to be models for post-Fordism. It appears that Toyota was able to take seriously the crisis of work because even in the old Toyotatism, strongly marked by the personality of T. Ohno, Toyota considered the management of its human resources to be important, recognizing that they constituted the motor within the Toyota machine. In any case, Toyota has interpreted the crisis of work as a tendential phenomenon and has chosen a radical solution.

This questioning of the production system has finished by modifying the idea of 'just-in-time' and the management of productive efficiency: 'just-in-time should not be applied to people', and 'we should not think solely about productive efficiency'. Hence a humanization of the production system and of work was launched. By investing massively to improve working conditions, by developing a new conception of the production line, by allowing segments of the line to keep buffer stocks, by making social relations of work more equitable and rational, Toyota has changed the rules of the game. For Toyota, 'lean production' appears to be the model of the past, because it placed too much pressure on people. The new strategy at Toyota is to give a more humane dimension to its production system but without hindering productivity; even if progress remains slow, and is held back by the old Toyotatism.

By contrast, Toyota Motor Kyushu seems to have detached itself from Toyotatism. In abandoning the management of productive efficiency created by T. Ohno, it gives more autonomy and more responsibility to work groups thanks to the new assembly line. In organizing back-to-back shifts, it renders both overtime and night work impossible. A new boost is given to 'team work'. Toyotatism thus appears to have entered a new era in which

Table 3: Toyota Motor Kyushu

Subsidiary established:	February 8th 1991
Capital:	45 billion yen
Products:	Mark II (medium class)
Production capacity:	200,000 units annually
Construction Start:	April 25th 1991
Production Start:	December 22nd 1992
Total Investment:	150 billion yen

Note: The level of automation is lower than at the 4th Tahara factory

<i>Work force in 1993</i>	<i>May, one shift</i>	<i>November, two shifts</i>
Plastic plant	77	103
Unit plant	47	71
Stamping plant	61	103
Body plant	205	278
Paint plant	165	266
Assembly plant	395	795
Head office	200	250
Others	150	384
Total	1300	1970
Production per day	400	600

it is possible to speak of 'autonomization' in its true sense, in other words, the 'autonomization of people'. In the old Toyotaism, this word meant providing the machine with an apparatus which would stop it if there was an anomaly in its functioning, and the same idea was applied to production workers, who were supposed to stop the line when they experienced a problem. People were thus treated like machines, even if this was necessary to guarantee quality at each stage. In the new Toyotaism, people should have more 'autonomy' in their work at the same time as they should assume more responsibility.

The experiments at Toyota Motor Kyushu appear to be having an impact on Toyota itself. In February 1994, management and the union at Toyota began negotiations on the introduction of back-to-back shifts with neither overtime nor night work. This happened even though the union had categorically denied that it was possible when this author undertook interviews there in December 1992. Of course it would be difficult to install the new assembly line in the old factories, because they lack sufficient space. But the third division of the production technology department will come up with a new method of realizing the new concept.

In the current recession, the new factories are not profitable. The rate of capacity utilization at the fourth Tahara factory was only 50 percent in October 1993, while that at Toyota Motor Kyushu was about 75 percent in November 1993. And yet these factories do not want to become 'factories of despair', but 'pleasant factories'. The new Toyotaism may be far removed from the Uddevalla model or the Kalmar model, and yet the attempts to escape from the fatalism of the assembly line and to give a more humane dimension to assembly work appear to be the shared preoccupations of these models even though different practical measures have been taken, not to mention the different sizes of the factories. But are there not differences in the methods used to humanize work between the Kalmar and Uddevalla factories? Despite the closure of the Volvo factories at Kalmar and Uddevalla it appears that the principles of the new industrial model are to be found in the humanization of work, and that the new Toyotaism may be seen as a leading model in the current situation (given the closure of the two Volvo factories) in terms of simultaneously creating productive efficiency and humanization of work; which is not, of course, to suppose that there is only one model for the future.

Notes

1. Translated from the French by Sybil H. Mair.
2. On the overall state of the Japanese automobile industry at the start of the 1990s, see the well-known report of the JAW (1992), which characterized it as a 'triple suffering' in terms of exhaustion of employees, low profits, and trade conflicts (especially with the United States).
3. On the detailed functioning of this system, see Shimizu (1994), which explains the relationship between the management of costs, the salary system (remuneration for production), and Kaizen activities.
4. To simplify, productive efficiency can be considered as the relationship between the standard time of production and the real time of production.
5. On the creation of these workplace relationships see Shimizu and Nomura (1993:32–36).
6. Toyota insists upon a special training for candidates for supervisory posts, in which they receive off-the-job training and on-the-job training in Kaizen methods, which are viewed as equivalent to the Toyota production system.
7. According to the public affairs department, the turnover rate amongst new recruits reached 20 percent in 1990. For production workers only, the turnover rate was reportedly higher still. According to the Toyota union, it was approximately 25 percent around 1990. With reforms to working and living conditions, but also the introduction of a new first training scheme for these young employees, the rate was halved in 1991.

8. The Kaizen objective was even imposed on office and engineering activities, but here it has been replaced by supervision of overtime hours.
9. According to the personnel management department, the situation of the indirect section (maintenance) will vary according to factory, but the tendency will be for it to be integrated into the direct section. The goal is to broaden the skills of the production workers towards those of the maintenance technicians. There is currently a wide difference in skills between the two, due largely to differences in their training.
10. In 1990, Toyota decided to reduce annual working hours by 300 hours between 1991 and 1994. According to the personnel department, annual hours per person were 2,284 in 1989, 2,273 in 1990, 2,173 in 1991, 2,029 in 1992, and 1,915 in 1993. According to the union, the rate of utilization of paid annual holidays was 70 percent in 1990 and 90 percent in 1992, and would be 100 percent in 1993.
11. In the case of the assembly factory at Motomachi, the training is spread over nine months (in 1993, from April to December). While there is a general manual concerning initial training, the factories are authorized to organize it as they see fit. However, the Motomachi case is clearly exceptional.
12. The line for preparing seats no longer exists, since they are now prepared by external suppliers.
13. The fundamental concepts behind the fourth factory are: to manufacture top-of-the-range and ecological automobiles but at a reasonable price, and with the most advanced technology; to attempt to motivate the employees by broadening their skills, with an emphasis on working in teams.
14. The administrators, managements and supervisors at Toyota Motor Kyushu have volunteered to leave Toyota to work in Kyushu, which is their region of origin.
15. On the full range of human relations activities at Toyota, see Shimizu and Nomura 1993:46–48.

References

- JAW (1992) *Japanese Automobile Industry in the Future: Toward Coexistence with the World, Consumers and Employees*, February.
- Nomura, M. (1993) *Toyotismu*. Mineruva.
- Shimizu, K., and Nomura, M. (1993) 'Trajectoire de Toyota: rapport salarial et système de production' in *Un Nouveau Toyotisme? Actes du GERPISA Réseau International*, No. 8.
- Shimizu, K. (1994) 'Kaizen et gestion du travail chez Toyota Motor Co. et Toyota Motor Kyushu – un problème dans la trajectoire de Toyota'. Communication pour la Deuxième Rencontre Internationale du GERPISA Réseau International, 16th–18th June 1994.

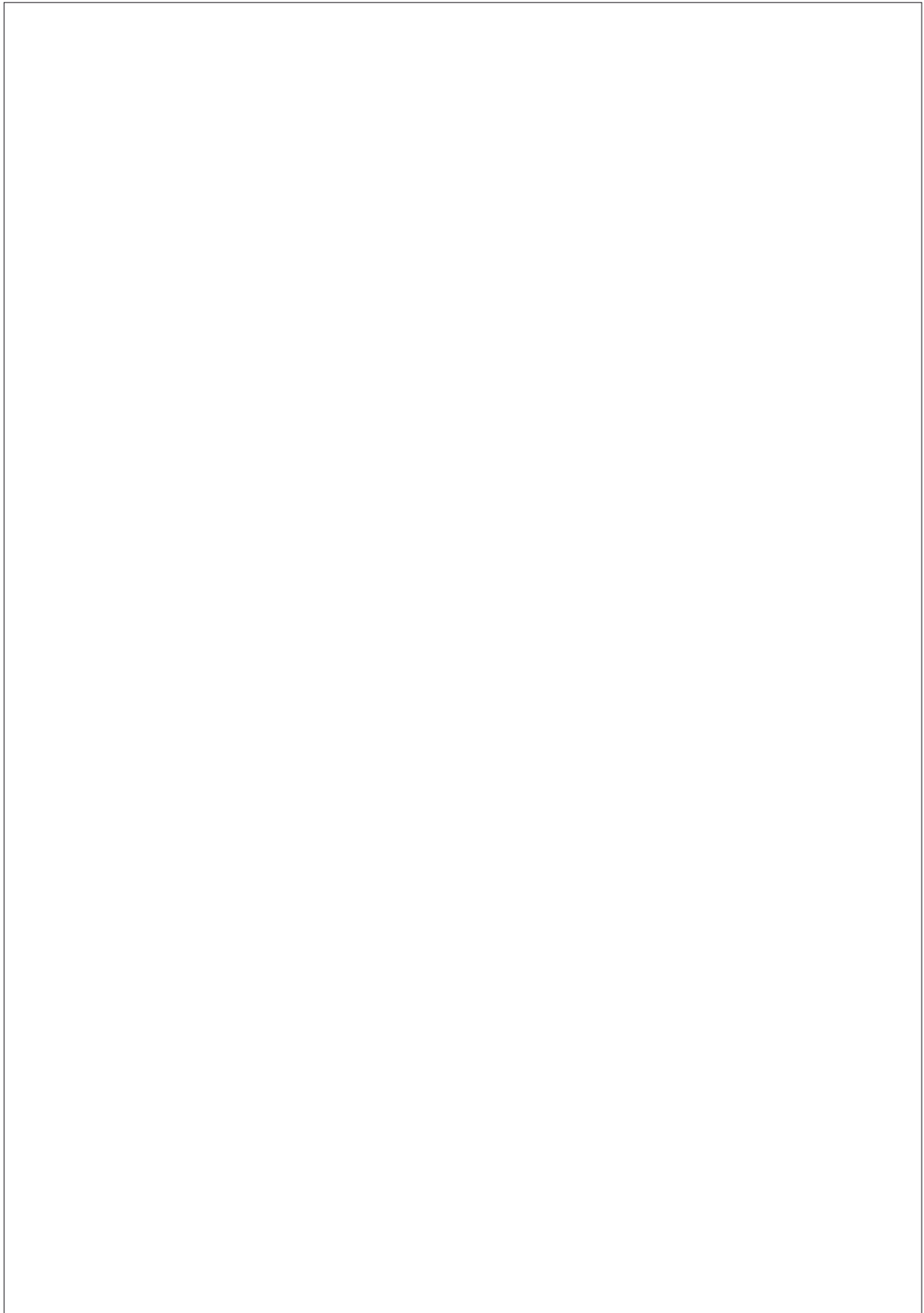

Recent developments at Toyota Motor Corporation:

The emergence of a 'Neo-Toyotism'?

Terje Grønning

Introduction

This chapter calls attention to some questions connected to the analysis of conditions within the Japanese auto industry.¹ The point of departure derives from the observation that there are presently several developments within this industry and that there is a probable mismatch between the developing patterns and concepts developed within studies of the Japanese labour process.² Several significant organizational developments have occurred, such as: the reorganization of the corporations, the reform of personnel management institutions, internationalization and diversification. In addition, there is a discrepancy between the relatively medium-tech process depicted in the theories and the fact that some of the experiments now being proposed actually are relatively high-tech.

Indeed attention has been given to the question of possible trajectories for future developments within the Japanese auto industry (Kaneda, 1991; Nomura, 1992; Nomura, 1993; Fujita, 1994), or even within the auto industry at large (Winter, 1994). Kaneda identifies the key functional areas of the current 'Toyota Production System' as: quality, ability to deliver on time, and cost. This puts the mind set of industrial engineering and continuous local process improvements in focus. In Kaneda's thesis of the coming agile production system, the key functions will in contrast be flexibility, service and amenity, and more far-reaching systemic improvements will continuously become necessary. In addition, the new system will among other things, according to Kaneda, require a reorganization of supplier companies, modularisation of production and networking (Kaneda, 1991: 252–253).

Nomura (1993) records some of the recent and observable changes occurring within the Toyota Motor Corporation. He lists eleven areas of such changes, and these range from a flatter organisational structure to declaration of new corporate policies (1993: 223). He analyses the developments

as being corporate reactions towards the potentially problematic areas within 'toyotism' that have surfaced during the current economic recession in Japan. But he questions whether there is evidence for the claiming that the method of continuous process improvements has been fully usurped (Nomura, 1993: 229). He is however, like this author, interested in observing the labour market driven changes, and he thinks the most interesting area for further research is to question where the corporation in the future will seek its basis for competitiveness in the case of a situation where factors for competitiveness related to the labour market become weakened (Nomura, 1993: 231).

Fujita (1994) is also taking his point of departure in recent observable changes. He lists these as: various difficulties in maintaining the kind of 'just in time' system like the one that has been practiced thus far; difficulties in connection with recruitment; and changes in the organization of work due to higher levels of automation in final assembly (Fujita, 1994: 91–93). But he admits that further research is needed in order to be able to analyse the inter-relationship between these and other changes (Fujita, 1994: 95).

There is thus, a considerable interest in investigating the question of whether 'toyotism' itself is in the process of developing into a fundamentally different form of production organization. The time should soon be ripe for broader empirically and theoretically based reviews of conditions in Japan and thereby, provide material for discussions on the possible emergence of a 'neo-toyotism'. Analysis of such developments is however, difficult, both from a theoretical and an empirical perspective. One such problem, is the difficulty of discerning between limited, short term counter-conjunctural campaigns and more long ranging developments. Another, is the availability of data at the current stage. It should be pointed out that this paper is a tentative work, one which utilizes a specific case study of the largest manufacturer, Toyota Motor Corporation. The basic source is written materials for in-company use such as the company newspaper (*Toyota Shinbun/Weekly Toyota*) and supervisor bulletins. Additional information has been collected from public sources, such as newspapers and industry journals. The case study does moreover, concentrate on certain selected institutions and elements instead of making an attempt at presenting an encompassing analysis. The focus is also limited in the sense of being based mainly on announcements of corporate policies, not on a follow-up of actual implementations.

Within the borders of these methodological and thematical limitations, the study focuses on the following issue. There have been a number of policy announcements during recent years. Issues that have emerged as central within the policy discussions, concern the problem of how to improve earning rates by implementing 'a new production system', implement more competitive personnel management reforms as well the need to handle

anticipated recruitment difficulties, changes in workforce composition, and changed perceptions among the current workforce.³

One may thus, detect a preoccupation with 'productive' investments and new forms for improving earning rates at the same time as labour market driven 'non-productive' investments seem to be necessary. The resulting strategy has turned out to be an increase of both 'productive' and 'non-productive' investments accompanied by programmes for stimulating increased efficiency.

1. Change in overall corporate strategy

This paper will mainly focus on certain labour market aspects of the way Toyota Motor Corporation management currently views its situation. But such selected aspects must be related to other attempts within the reorganization strategy. In this section, I will offer an overview of the most significant of the policy changes. The description covers changes in overall corporate strategy, attempts at internationalization, measures for reorganizing the domestic basis, and measures towards achieving diversification.

1.1 Policy statements

Throughout the 1980s, Toyota has launched several propositions concerning what should be the corporation's overall strategy in the future. After a peak in earnings in the fiscal period ending June 1985, huge decreases in earnings followed mainly due to a strengthening of the yen that began in late 1985. Toyota subsequently established a 'Committee for Urgent Measures Against the High Yen' (October, 1986). After assistance by an abrupt increase in domestic demand, earnings improved. There were however, continued efforts for outlining a strategy that would secure high earning rates also in the future, and by the late 1980s the Toyota strategy had been drawn up in the form of stressing the need for pursuing the following three pillars in order to secure earnings in the future (cf. Miyazaki, 1994):

1. Development of a strategic pattern of activities overseas in order to emerge as an 'international corporation'.
2. Reorganization of domestic production in order to 'strengthen the domestic basis'.
3. Strengthening of new fields of activities in order to diversify.

These new priorities were further developed and conceptualized in the company's new set of official policies declared in early 1992. The new policies replaced the 'Toyota General Principles' (*Toyota Koryo*) that had been in existence since 1935. The main theme of the new corporate policy was formulated as becoming 'a corporate citizen that is being trusted by the

international community'. The three main areas for concentrating the efforts were identified as: *internationalization, the environment problem, and efficient use of management resources*. These priority areas were then further clarified in the form of seven paragraphs. Here are excerpts from them:

1. Strive to be a corporate citizen trusted by the international community by having open and fair corporate behaviour as the basis.
2. Strive for a more affluent society and a better world by making the supply of 'green' and safe products our mission.
3. Strive to supply products that are full of attractive features and thereby, respond to the demands from customers from all over the world through making efforts at research and development within the most advanced technology of various fields.
4. Contribute to the industrial economy by having our activities adapted to each country and each region they are localized in.
5. Create a company spirit where the individual's creativity and the strength of teamwork is heightened to an optimal level.
6. Maintain a steady growth through efficient management on a global scale.
7. Achieve long term steady growth, co-existence and co-prosperity by conducting transactions on an open basis (Toyota Motor Corporation material dated 1992/*Weekly Toyota*, 1 January, 1993).

Apart from such policy statements at a rather abstract level, top management has occasionally gone into somewhat more detailed explanations mentioning specific target areas, such as, efforts for reconsidering the production system. One occasion where such questions surfaced was in the 1993 new year announcement directed to the employees. Within the areas that were to be given priority in 1993 and onwards, the president singled out the 'effective use of management resources' as the most important field in the announcement. This field included subjects such as, a reconsideration of the product lineup, reduction of direct material expenses, optimalization of investments in equipment, and development of a flexible production organization that connects to improved earning rates (*Weekly Toyota*, 1 January, 1993:1).

Moreover, Shoichiro Toyoda, chairman of the corporation since 1992, has in a recent article used the term 'new production system' when summing up various issues that the corporation is facing:

In the production shops ... [we need to consider] the development of a '*new production system*' that is responsive to the reduction in the number of skilled persons and other changes in the quality of the workforce and that is responsive to a production formation that has taken on international proportions. [We also need] to consider production shops where it is possible to feel attraction towards manufacturing and a sense of

fulfillment in connection with manufacturing, and there is a need to secure personnel within middle- and long range technologies (Toyoda, 1993, his italics).

In this particular article, Toyoda does not offer further details as to what the 'new production system' should consist of, the nature of 'the reduction in the number of skilled persons', nor details on what kind of technologies constitute 'middle- and long-range technologies'. But both these statements by Toyoda concerning a new production system, as well as, the earlier statements concerning an effective use of management resources may be juxtaposed with the way the production system thus far has functioned. The point of the production system has been to minimize manufacturing costs by eliminating wasteful elements within production (Ohno, 1988; Nomura, 1993: 24). By minimizing manufacturing costs, it follows that the gap between manufacturing costs and turnover is likely to increase. Thereby, the corporation will see its earning rates steadily improved.

The policy statements and the Toyoda paper do however, reveal that the corporation has started to doubt the continued success of this production system. One factor behind such reflections is issues related to the product market. And the other factor is, as we will return to in further detail below, related to the labour market by way of 'changes in the quality of the workforce' (Toyoda, 1993).

And when these are put together, the way of making an effective use of management resources will definitively have to take the form of a new kind of production system. The components of the new production system remains to be seen. However, as tentatively outlined by a previous manager in a Toyota Group company, the mechanisms for steadily maintaining a satisfactory gap between manufacturing costs and turnover will probably have to be thoroughly altered (Kaneda, 1991).

1.2 Internationalization

Activities for achieving internationalization have, both before and after the corporation went public with the strategy cited above, tended to be divided into two distinct trajectories. One is the transfer of production to regions with low cost levels in terms of labour wages etc., while the other trajectory consists of transfers to regions with high cost levels.

The former strategy has been pursued for years with the establishment of 'knock down'-production in countries such as South Africa (1962), Malaysia (1968), Portugal (1968), and so on. What is new within this low cost trajectory is the transfer of larger chunks of parts production overseas and the construction of an integrated system for distributing the parts produced. Such a distribution system has been created in the low cost countries of East Asia and South-East Asia (Japan Auto Industry Survey, December 1992:3).

The latter strategy consists of establishing partly or fully integrated assembly plants in countries with high cost levels signifies a major innovation regarding measures for achieving internationalization. In the United States, the semi-integrated New United Motor Manufacturing Inc. (NUMMI), was established as a joint venture with General Motors in 1984. NUMMI was a semi-integrated facility in the sense that engines were not produced on site, but were shipped from Japan. The plant was followed by the completely integrated Toyota Motor Manufacturing U.S.A. Inc. in 1988.

In Canada, Toyota established a smaller plant (Toyota Motor Manufacturing Canada, in 1988), and more recently a plant in Britain has started production (1992).

1.3 Reorganization of the domestic basis

The activities for reorganizing the domestic basis include efforts concerning the structure and geographical location of the corporation itself. Diversification constitutes another area for activities. A third area is the changes in the production system and in organizational structures, i.e. the changes described in further detail in the main bulk of the paper.

The restructuring process started with the merger of Toyota Motor Corporation and Toyota Motor Sales in 1982. With this merger, the contours of a corporation with strong integration between production and sales emerged. On the production side, a parts plant was established in Hokkaido (with production start-up in 1992) along with a fully integrated assembly plant in Kyushu (with production start-up in 1993).⁴ The corporation thus emerged with a more dispersed production structure than previously.

The attempts at diversification may be summarized as follows. Diversification has occurred mainly in the form of establishing separate divisions devoted to the development of new corporate target areas. Between 1984 and 1991, a total of 19 companies with a total of approximately 4,530 employees were either invested in, acquired or newly established. Two of these companies were within aerospace, five were within communications, and six were within high-tech (Japan Auto Industry Survey, April 1993:4).

2. Changes in Toyota production organization since 1980

At first sight, the development of the production organization at Toyota Motor Corporation in the past decade consists of an increase in the number of models and the number of variants within each model produced. At the same time, there has been a decrease in the general changeover time between models. Product line has also been altered, with the addition of high value-added luxury cars (Kojo Kanri, Plant Management, 1990:101). Moreover, these developments have come at a time when the company has moved from

a rather conservative stance when it comes to the use of advanced production technology to a strategy of increased automation levels.⁵

One should however, be cautious when analyzing these trends since there have recently been some scale-backs. The recent low conjunctures (and the completion of several major construction projects), may have resulted in a strategy of scaling back the levels of investments in high technology. The low conjunctures have also led to Toyota decreasing the number of variants offered, commonization of components, and increased lead time for new product development (Miyazaki, 1994). Also, with regards to automation levels within final assembly, another factor behind scale-backs may be the increased cost (as relative to the usefulness and flexibility) of certain types of new technology, with the result that automation levels have remained lower than the 20–25 percent that were initially projected. In other words, automation activities within final assembly had to take into consideration their applicability and cost in addition to their labour saving capacity, claims that are not easy to fulfill within mixed model production (Automotive News, 26 October, 1992:14i).

It is thus, very difficult to outline general trends in Toyota strategies and to assess how much the recent scale-backs are a result of circumstances or a result of conscious deviations from long range strategies. Nevertheless, this section attempts to present an outline of main developments within production organization during the last decade or so.

2.1 Investments in facilities and equipment

Toyota investments in facilities and equipment during the second half of the 1980s, were fairly high when seen in comparison with the other auto corporations (Kitamura, 1990). Towards the end of the 1980s, the spending by Toyota, Nissan and Mazda showed significant increases, although Toyota's spendings increased the most. These three companies incidentally spent the most because of major construction projects, with Nissan building a new plant in Kyushu and Mazda a new plant in Hofu. Toyota built a total of five new plants and two additional lines at an existing plant. Two of the new plants were in Toyota City. One of these was for the production of parts and equipment (Teiho plant, 1986), and the other was for the production of electronic control devices, sensors, and so on (Hirose plant, 1989). In addition, the plant in Tahara Town was enlarged with two additional lines (Tahara III, 1989, and Tahara IV, 1991), with the latter of these being the line within the corporation with the highest density of high technology (Automotive News, 25 January, 1993:23).

Toyota also initiated its plans for expanding production to other areas than Toyota City and Aichi-ken (Aichi Prefecture) during the latter half of the 1980s. A new plant in Hokkaido for producing various parts did, as

mentioned above, open in 1992, and the new plant for the production of upper-scale small-sized cars in Kyushu, started production in spring, 1993. Domestic Toyota production capacity was at the time calculated to produce approximately 4,800,000 vehicles by 1995, when final assembly by other companies within the Toyota Group was included in the figure.⁶

As for the most recent spending behaviour, Toyota and the other Toyota Group companies have been in the process of ending the large projects mentioned above. Also other companies like Nissan and Mazda have completed their projects, and figures for capital spending are showing huge reductions.⁷

2.2 The Tahara IV and the Kyushu plants

The Tahara IV plant is one of Toyota's pilot projects when it comes to experimenting with the application of new types of machine technology and organizational innovations, according to a study by the auto industry survey firm Press & Data Service (PDS) International (1993:233). The main differences between the Toyota assembly plants with conventional production processes and Tahara IV is that the former system 'balances the need for mixed model production with the need to maintain high productivity through continuous flow of production', while the latter has got 'quality assurance' and 'improved working environment' as priority areas, in addition to 'maintaining high productivity'.

Some of the new machine technology and the new methods in use at Tahara may thus, be interpreted as meant for alleviating the possible contradiction between wanting improved quality and productivity levels simultaneously with an improved working environment. Such innovations include the use of automatically guided vehicles that have adjustable height and sideways movements, automated engine and chassis installation, and the making of parts of the assembly process 'modular'. In the latter respect, the plant's assembly process is only slightly less advanced than Mazda's Hofu II, the industry leader in the field of modular assembly (Japan Auto Industry Survey, December 1992:12; PDS, 1993:234). The assembly process at Tahara IV has in its present state however, been found to be more costly than that of the conventional lines (PDS, 1993:234).

The scale of the Kyushu plant in southern Japan is 200,000 units a year. The investments in machine technology are, according to reports (Asahi Shinbun, 5 April, 1991; PDS, 1993:95; Nomura, 1992:9), concentrated on worker environment rather than on automating the final assembly process. The attitude towards automation has been described as resembling Toyota's overall step-by-step attitude (PDS, 1993:95), and the most remarkable innovations are on several organizational solutions.

First of all, the shift system and the workforce composition are different

from those at the other Toyota plants. While there are two shifts alternating weekly between a day shift and a night shift at the other plants, the Kyushu plant has got two shifts that run from about 06:00 AM to 03:15 PM and from about 04:15 PM to about 12:45 AM (PDS, 1993:94). In this way, the Kyushu plant circumvents the Japanese prohibition against letting women work in manufacturing during nights, and has in fact recruited female workers. Secondly, the organization of the production process is reported to contain certain production buffers within the production flow. This principle seems to fly in the face of a crucial principle within the overall Toyota Production System, in which stock-in-process constitutes an utmost evil in the form of waste (Ohno, 1988). Kyushu has however, allowed a certain amount of stock between its teams consisting of approximately 10 workers each. And these teams are then supposed to have a certain amount of autonomy concerning how to perform the tasks within the team (Asahi Shinbun, 5 April 1991).

Other Kyushu innovations include the way the plant was financed, establishment as a separate, incorporated company, and a slight departure from the JIT system, consisting in collecting bulk supplies from Aichi Prefecture suppliers for shipment to Kyushu.⁸

The experiments at the two plants of Tahara IV and Kyushu, exemplify several strategies at a corporate level. On the one hand, the changes are aimed at increased levels of productivity and efficiency. They do however, on the other hand, seem to be aimed at adjusting production in some degree to workforce needs and characteristics. For the Kyushu location, an additional feature supporting the second point includes the fact that a major part of the workforce at the previous production sites, did in fact migrate from the Kyushu region to central Japan (Oyama, 1985; Nohara and Fujita, 1989). By locating the new plant in this region, the corporation obviously aimed at reducing recruitment related problems.

2.3 *On scale-backs*

There have been some scale-backs when the present state of affairs is compared to the original plans. The corporation did recently decide that it should deviate from the original five-year plan and reduce the size of investments by 20 percent. One Toyota manager has commented on the high cost of flexible machinery in the following way:

It is pressing our corporate earnings down. A few years ago, it cost 20 million yen to replace one worker. Now it costs 35 million yen. We had to bring it down to 20 million (*Automotive News*, 26 October, 1992:14i).⁹

In connection with the scale-backs, the corporation was thus, faced with the problem of deciding upon which areas to target for reductions. The corpora-

tion has as mentioned in the introduction, generally been dividing between two types of investments, 'productive' and non-productive'. According to one company official: 'about half of the investments are of a type that do not lead to increased production' (Nihon Keizai Shinbun, *Japan Financial Times*, 27 July, 1992).

The kind of investments included in this 'non-productive' category do however, include both R&D as well as 'welfare and benefit programs in order to secure the recruitment of young workers', and the corporation has reportedly found it 'difficult to reduce' the level of such investments (Nihon Keizai Shinbun, *Japan Financial Times*, 27 July, 1992).

3. Reform of personnel management institutions

In this section some primary personnel management reforms, concerning reform of the status system, the personnel assessment system, and the wage system will be presented in some detail. Thereafter, some other organizational changes and personnel management reforms will be treated somewhat superficially.

3.1 Reform of status system

The Toyota status system distinguishes between ranks and statuses. The latter corresponds to whether a person holds an administrative post or not, and to what level this post is situated. But, since there are ranks in addition to the statuses, the system allows for considerable flexibility in personnel management by accommodating rank promotions without actually promoting a person to an administrative post or to a status of a higher level. The persons belonging to a particular administrative level do not have to be of the same rank or grade. This is because the rank ladder and the status ladder are, in spite of being parallel, not strictly interconnected. Some in-company representations of the rank and status ladder do in fact indicate the possibility of a person in, for example, a group leader position being of either one of three different ranks (cf. Grønning 1992:174; Nomura, 1992:22). The system does in this way serve as a managerial tool for handling a workforce consisting of individuals with varying levels of skills and managerial potentiality under conditions where there are a restricted number of posts.

The present system is termed the 'Job Ability Rank System' (shokuno shikaku seido). It emerged from the 'Job Level System' (shokuso seido) which had been institutionalized in 1966. In 1987, however, the 'Job Ability Rank System' was instituted, and it was thoroughly revised in 1989 and in 1991.

Although the new 'Job Ability Rank System' is no major break from the 'Job Level System', the new system is considerably more sophisticated. In

addition, one of the innovations within several 1991 blue collar institutional reforms, the implementation of a system of 'Special Competence Posts' (senmon gino-shoku), signifies a development of the status system. Instead of just being promoted to a higher rank, the new institution of 'Special Competence Posts' signifies that persons may actually be promoted to a higher status, even when they are not promoted to a specific administrative post.

Such special competence persons will, according to an announcement in the company paper, be allocated concrete, special tasks such as prototype related work, assistance at plants abroad, education, practical work that requires a wide range of experience, and so on. The system has also incorporated a flexible component in securing that persons in regular administrative posts may, 'when the need arises', be rotated with special competence persons (*Weekly Toyota*, 1 February, 1991:2).

The implementation of such 'Special Competence Posts' may thus, turn out to be an interesting development. It is however, necessary to investigate in future research for what reasons and to what extent the institution actually is being implemented. Subjects for such investigations include for example the question of whether the new institution simply is a project for handling the problem of having promotable persons within the current workforce without having available posts, or if it is an institution which will have an indispensable place within a particular form of future production organization.¹⁰

3.2 Reform of the personnel assessment system

The personnel assessment system is the primary tool for placing workers in the different ranks and statuses. The system is also used in order to connect ranks and statuses with appropriate wages, as well as, in order to connect a promotable person with prepromotion education (Tanaka, 1982).

The most important developments concerning the personnel assessment system are as follows. Assessment, which was previously a holistic, 'total', assessment has been subdivided into two types: ability assessment and periodic assessment (see Table 1). While ability assessment is annual, periodic assessment occurs semi annually.

Moreover, for the new periodic assessment, a person's assessment results may range between 80 points and 120 points as compared to the 85–115 range for the ability assessment and for the previous, holistic assessment system. Both the previous system and the new form of assessment are based on a zero-sum principle, i.e.; a system where 110 points awarded to an individual within a certain section means that another person may be awarded only 90 points. The increase in range for the new periodic assessment means that differentiation between individuals may occur in a greater degree than before.

Table 1. Personnel assessment system

Type, name of assessment	1. Ability assessment	2. Periodically assessment		
		Ass. for job ability wage	Ass. for summer bonus	Ass. for winter bonus
Philosophy of assessment	<ul style="list-style-type: none"> Assessment of abilities possessed 	<ul style="list-style-type: none"> Assessment of abilities displayed during period¹ 		
Reflection of assessment	<ul style="list-style-type: none"> Raise in base wage Promotion 	<ul style="list-style-type: none"> Ability wage² 	<ul style="list-style-type: none"> Summer bonus 	<ul style="list-style-type: none"> Winter bonus
Scope of assessment	85–115	80–120		
Assessment elements	1. Knowledge, experience 2. Supervising ability 3. Ability for KAIZEN, suggestion 4. Voicing opinion, affirmativeness	1. Result of work 2. Attitude towards task 3. Safety		
Assessment period	<ul style="list-style-type: none"> Feb. 1 of previous year–Jan. 31 of present year 	<ul style="list-style-type: none"> Nov. 1 prev. year–Apr. 30 pres. year 	<ul style="list-style-type: none"> May 1 –Oct. 31 	
Assessment time	<ul style="list-style-type: none"> March 			<ul style="list-style-type: none"> October
Assessment group	<ul style="list-style-type: none"> In principle, separately for each rank 			
Assessment rank	<ul style="list-style-type: none"> Total and relative assessment while referring to each assessment element (5-ladder-ass.) Regulation according to average of department/assessment group 	<ul style="list-style-type: none"> Accumulative evaluation of 2 assessment elements (5-ladder ass.) Department/assessment group with regulation finished within department 		

Notes: This outline of the personnel assessment system applies for the manufacturing related personnel. (System for technical and office personnel is slightly different.)

- Does not take into consideration ability, experience, etc. acquired outside the period.
- Does not influence promotion.

Source: Reproduced from Toyota Motor Corporation in-company material, March 1989, pp 7–8 (outline of system except ‘scope of assessment’), and Toyota Motor Worker’s Union material, September 1989, p. 9 (‘scope of assessment’)

Finally, we may detect from the new elements for consideration within assessment (Table 2), a focus on both the value of avoiding mistakes as well as on the value of taking initiative.

3.3 Reform of the wage system

In connection with the institutional reforms within personnel management, the wage system has also undergone major revisions:¹¹

The reason for reforming the wage system is to clarify the element of 'getting rewarded if one makes an effort'.

1. A system where the deciding elements are clear and one which the employees will easily accept.
2. To wipe out attitudes giving priority to stability with the implementation of a system which can invite an attitude of continuously challenging goals.
3. A system which definitively can reflect an individual's ability (Toyota Motor Corporation brochure dated March, 1990:1).

The concrete innovations do, when overtime pay is excepted from the description, mainly reduce the proportion of a person's wages that is being determined by the efficiency of the group that the person belongs to. Instead, priority is given to individual efficiency and work attitude.

The new system has got the following components:

- 'production allowance', which reflects work group efficiency (40 percent)
- 'base wage', as reflected by ability assessment results (40 percent)
- 'age wage' (10 percent)
- 'job ability wage', as reflected by periodic assessment results (10 percent)

While the former system had the three components 'base wage', 'production allowance' and 'rank allowance', the latter component is in the new system included in a component called 'job ability wage'. It is noteworthy that although a component called 'age wage' has been identified as a separate entity that is entirely liberated from assessment results, this portion is a mere 10 percent of the total amount.

Besides these changes, the way of calculating efficiency has according to Nomura (1992:6-7) been altered or will be altered in the future. Efficiency rates will hereafter apply not only to production department employees, but also for maintenance and technical employees while measuring against a coefficient derived from a so called 'standard time'. Females and older workers will however, be allowed longer 'standard time' than young males.¹²

Table 2. Elements for consideration in personnel assessment

1. Assessment elements for ability assessment

Special knowledge, techniques	<ul style="list-style-type: none"> • Is able to handle work of great difficulty as well as taking care of numerous tasks and respond to sudden situations. In other words, has sufficient knowledge/techniques while having a profound understanding of the rules and regulations for safety and employment conditions. Is also fervently involved in self education
Ability for contributing to continuous improvement	<ul style="list-style-type: none"> • Is always problem oriented and participates whole-heartedly in activities for continuous improvement. Is also actively involved in offering opinions in the relevant situations.
Ability to supervise and instruct	<ul style="list-style-type: none"> • Shows the leadership necessary for his position. Is also good at supervising while understanding the feelings of his people.
Sense of responsibility, cooperation	<ul style="list-style-type: none"> • Has a strong sense of responsibility for his work and acts cooperatively while understanding the state of the company and the workplace. • Is also, based on mutual trust between management and labor, contributing to creating a pleasant workplace.

2. Assessment elements for periodical assessment

Results of work and activities for continuous improvement	<ul style="list-style-type: none"> • Performed the day-to -day tasks accurately, was vigorously involved in solving difficult problems as well as showing concrete results in connection to activities for continuous improvement. • Also showed concrete results in instructing/training his people in the planned way.
Attitude towards work	<ul style="list-style-type: none"> • Obeyed the various rules and regulations as well as the instructions and orders of his superiors. Was fully involved in his work and cherished teamwork. Did also show an effort in enabling communication between top and bottom.

Note: Applies for assessing sub-section leader and below. The various elements or the relative weight of elements may vary according to the rank of the assessee.

Source: Toyota Motor Corporation in-company material, March 1990, p 3

3.4 Some other reforms

The question of altering the corporation's shift system surfaced in 1989 and in 1993. Toyota plants have, as mentioned above, normally operated with two-shift systems, with workers alternating weekly between day shift and night shift. Legislation and prejudice against female workers working nights meant that female hires were excluded under this system. With a system of two daytime shifts, both female workers and others reluctant about night shifts, could be attracted to work in the industry.

The 1989 labour and management committee discussed the goal of no more than 1,900 hours in total working hours for any employee. The plan that was discussed at that time would however, necessitate an additional 6,000 workers, of which 3,000 should be new recruits while the labor output of 3,000 workers should be secured through automation (Nihon Keizai Shimbun, *Japan Financial Times*, 29 July, 1992). The plan did in addition contain several suggestions on reform of how working hours were structured (Nomura, 1992:4).¹³

In the discussions of the 1993 committee, a new system was planned to be designed around the time slot between 6:00 A.M. and midnight, i.e. ca. 18 hours. With such a time frame, there would however be several obstacles that would have to be resolved in order to make the system viable: the employees are used to the significant portion within their wages coming from overtime;¹⁴ parking lots would have to be enlarged; the system would have to be implemented simultaneously at all the plants since the new working hours would have to be coordinated with the suppliers; and so on (*Chunichi Shinbun*, 6 July, 1993).¹⁵ Moreover, such a system would mean that there is almost no room for overtime between the two shifts.

Concerning reforms specific to blue collar workers, the most comprehensive reform was implemented in February, 1991. One of the innovations at this occasion was the start-up of a System for Education in Special Skills. This new education system implemented at this time is built upon the three parts of 'competence in practical matters', 'basic competence', and 'special knowledge'. It is classified as a 'challenge system', meaning its objective is 'that each and every employee may, through his work, improve his abilities or feel where he stands'. There are four levels, and any worker with the certain amount of experience corresponding to one of the four levels may request the appropriate education (*Weekly Toyota*, 1 February, 1991:2). In addition, the 1991 blue collar reforms included the implementation of Special Competence Posts as reviewed above.

The organizational structure for white collar workers first underwent some fundamental changes in 1989. The changes consisted in altering the way of how to group the white collar workers. The previous pyramid-shaped organizational structure consisting of departments, sections and sub-sections

was altered with the introduction of 'groups' within departments instead of sections and sub-sections. The number of departments did remain about the same, but the number of 'groups' was only 633 as compared to the 758 sections of previous times.¹⁶

In addition, another white collar reform was instituted in June, 1993. This consisted in allocating 20 percent of the male workers (ca 800 persons) into special teams. These teams should take care of 'urgent issues', while the remaining 80 percent performed the day-to-day tasks (Nikkan Kogyo Shinbun, *Japan Industrial News*, 11 June, 1993; Nihon Keizai Shinbun, *Japan Financial Times*, 11 June, 1993, *Japan Auto Industry Survey*, September, 1993:3, 17).

The objective of this reform was thus to implement concrete measures that could contribute to the on-going efforts at organizational development. Not only are the persons assigned to the teams given the opportunity to devote themselves to the issues at hand. Another target for the reform was the work content for the portion of the workforce remaining with responsibility for the day-to-day tasks. This part of the reform aims at using the situation with decreased manpower levels to visualize work that is really necessary and work that is 'not needed' (*Japan Auto Industry Survey*, September, 1993:3).

Finally, a system for enhancing 're-recruiting' to the new companies within the Toyota group has emerged. With the additional companies resulting from the efforts at diversification, the Toyota Motor Corporation has gone to concrete measures for increasing mobility within the corporate group by recruiting people to the new companies from within the Toyota Motor Corporation itself (*Toyota Shinbun*, 3 August, 1990).

The two reforms of creating special teams and enhancing 're-recruitment' qualify for comments in the same vein as in connection with the presentation of Special Competence Posts above. This is to say that it is difficult to grasp the full meaning of these two reforms without conducting some further research where certain additional aspects of the two reforms are being investigated. For the special teams, it is possible to question whether the real significance of their implementation lies in concentrating particular workers in the special teams or in the effect on the workers with responsibility for the day-to-day tasks. A crucial question in connection to this is the question of what workers are being selected for the special teams. The character of this institution depends on whether the workers selected turn out to be the most outstanding workers, the workers that perform the poorest or if it is a combination of these two. Similar comments may be added in connection with the 're-recruitment' process. It is in other words a question of what type of workers that Toyota Motor Corporation will 'lose' to the new companies.

Conclusions

Toyota management has during recent years been preoccupied with how to handle an expected domestic worker shortage. Management has in addition been preoccupied with strategies for the improvement of the corporation's earning structure. There is a possible contradiction between simultaneous improvement of earning rates and increases in 'non-productive' investments in order to respond to workforce needs and in order to attract new recruits. The two themes may be interpreted as standing in a contradictory position towards each other in the following sense. Adequate recruitment levels in the future may in many respects necessitate increased levels of 'non-productive' investments. At the same time, a move towards strategies aimed at securing improved earning rates would perhaps favor as few non-productive investments as possible.

Regarding the way the workforce is being handled, there are within the developments reviewed here signs that management tries to retrieve with one hand what it gives out with the other. In order to secure recruitment or due to other reasons, management is considering concessions on certain areas. The workforce has already experienced, or will probably experience in the future, more responsive treatment in the form of e.g. more normalized working hours, a wage component reflecting age, and efficiency calculations taking into account sex and age of the employee. But more strict conditions are also evident, such as white collar worker rationalization, more frequent and more individualized personnel assessment, and company-wide calculations of efficiency rates. And it is especially noteworthy that indirect labor has become the specific target for rationalization measures and that this portion of the workforce is undergoing changes towards structures resembling the principles previously employed within the production department (e.g. groupification of labor and provoking rationalization through the removal of workers).

It should however be noted that certain aspects of the reforms warrant further research in order to get a full picture of the recent events. Such aspects include the nature of the so called Special Competence Posts, special teams for white collar workers, and the 're-recruitment' process within the enlarged corporate group.

It should also be noted that the labor market related reforms contain a number of other possible contradictions in addition to the basic contradiction suggested in this paper. In relation to the Toyota reforms we may discern possible contradictions such as the problem of how to create a new and ambitious production system under the condition of possible workforce shortage and a more heterogenous workforce than previously. And there is, as has become evident from the review of the more individualized assess-

ment and wage systems, a possible contradiction between wanting both to strengthen 'the individual's creativity' as well as maintaining traditional, Toyota-style teamwork.

In this paper, some of the most recent Toyota Motor Corporation activities have been presented and been tentatively compared to classical toyotist activities. Some of the activities may be characterized as varying from the previous institutions. Further research is however needed in order to become able to formulate the true extent of the changes in question. And further research is also needed if we want to follow the way of thinking about different forms of production organization as consisting of configurations ranging from supplier relations to in-company work organization. Regarding this last point, this paper offers far too little evidence. But some clues in this paper point to a possible future 'neo-toyotist' configuration consisting of at least the following characteristics: production and product development is dispersed both in a domestic and international sense, in contrast to concentration to a single prefecture within Japan; products consist of a wide range of products in addition to vehicles; workforce is heterogenous (young and older males as well as even females) instead of homogenous (young males); production organization combines mixed model production and high technology instead of adapting conventional technology to mixed model production; production system is to some degree responsive to changes in workforce composition, but wants simultaneously to be responsive to market input; and the personnel management institutions are designed in order to enhance the creativity of individuals as well as being designed in order to enhance the ability to function within a context of groupified labor.

Notes

1. A preliminary version of this paper was first presented at The 17th Nordic Sociology Congress, August 13-15 1993, Gävle, Sweden, with the title 'Aspects in Connection With the Introduction of New Technology in the Japanese Auto Industry: The Case of Toyota'. I am in the addition to comments at this conference indebted to Åke Sandberg, Cecilia Runnström and Katsuji Tsuji, who all took time to read through early versions of the manuscript.
2. There is obviously a large number of such works, but cf. e.g. Cusumano, 1985; Oyama, 1985; Nohara and Fujita, 1989; Tsuji, 1989; Wood, 1989; Womack et al, 1990; Elam, 1990; Totsuka and Hyodo, 1991; Helling, 1992; Grønning, 1992.
3. Changes concerning the latter point, i.e. changes in the current workforce's perceptions and values, has already been documented (Jidosha Soren, 1990; Tsuji, 1994:275).
4. Toyota did also plan the establishment of a parts plant in the Tohoku region, but construction of this plant has, according to the auto industry survey institute PDS International (1993), been postponed.

5. See Aichi Rodo Mondai Kenkyu-sho (1990:209) for figures on increases in automation level.
6. Toyo Keizai, *Far Eastern Economics*, 29 December, 1991. The prognosis was based on the figures for new plants and enlargement of existing plants (the Kyushu plant and a total capacity for the Tahara plant of 500,000 in the case of Toyota Motor Corporation itself as well as Kanto Auto Body's Iwate plant to be constructed within 1993, 200,000 vehicles, and Toyota Auto Body's Mie plant to be constructed within 1993, 80,000 vehicles) added to the 1989 production figures (2,244,000 for Toyota Motor and 1,732,000 for other Toyota Group companies).
7. The figures are, due to differences in when the respective fiscal years ended, not directly comparable. But in the fiscal year ending 30 June, 1993, Toyota registered a reduction of 20.5 percent (down to US\$ 3.92 billion), Nissan a 15 percent reduction (down to 1.58 billion, forecast based on fiscal year ending 31 March, 1994), and Mazda a 37.2 percent decline (down to US\$654 million, forecast based on fiscal year ending 31 March, 1994). The only company that was expected to increase their spendings in this period was Honda (*Automotive News*, 21 June, 1993:42).
8. See PDS (1993:95) and *Nikkan Jidosha Shinbun, Japan Automotive News* (16 April, 1991) for details on these aspects.
9. Another source states that 'Toyota long maintained a strict policy requiring the elimination of one job for every 10 million yen invested in automation. More recently, however, it has begun to relax this constraint, allowing investments of yen 15-20 million to meet changing requirements, such as the demand for shorter working hours' (PDS, 1993:232).
10. For the latter point, it is interesting to refer to the trajectories of future production as proposed by Kaneda (1991). He suggests that in place of the small-scale suggestions that have been the back-bone of production organization so far, the new form of organization will require more system-oriented suggestions for incremental improvements, and hence a new type of workers who are able to submit such suggestions. Special Competence Posts may turn out to be one of the elements within such a scenario.
11. It has been reported that wage system revisions were first implemented for the employees not being members of the union, i.e. those of section chief rank and above, in April, 1990, and that revisions for the remaining, unionized employees (ca. 63,000 employees) then followed in July, 1992 (*Asahi Shinbun*, 25 July, 1992).
12. Still another innovation is the introduction of different efficiency coefficients in casting, machining, body/painting/stamping, and assembly (Nomura, 1992:6-7).
13. Note that Toyota and other companies are anonymized in the papers by Nomura (1992), his colleagues (Totsuka and Hyodo, 1991), as well as another work being referred to in this paper (Nohara and Fujita, 1989), but that these publications

are being used as sources after having identified the corporations that are being described.

14. Toyota workers did during the 1980s on an average consistently work ca. 20 percent overtime (Aichi Rodo Mondai Kenkyu-sho, 1990:207).
15. Nomura (1992:9, 12) refers the details on the suggestions of the 1989 committee and explains that an experimental shift system consisting of three shift groups rotating two shifts commenced in January 1991 with a higher shift allowance (35 percent as compared to 25 percent previously) in order to compensate for reduced overtime income.
16. Cf. Miyazaki (1994) and Nomura (1992:2) for further details.

References

Automotive News.

- Aichi Rodo-mondai Kenkyu-sho (ed.) (1990), *Toyota gurupu no shin-senryaku* (The New Strategy of the Toyota Group). Shin Nihon Shuppan, Tokyo.
Chunichi Shinbun.
- Cusumano, Michael (1985), *The Japanese Automobile Industry: Technology & Management at Nissan & Toyota*. Council on East Asian Studies, Harvard University, Cambridge, Massachusetts.
- Elam, Mark J. (1990)., 'Puzzling Out the Post-Fordist Debate: Technology, Markets and Institutions', *Economic and Industrial Democracy*, vol. 11, pp. 9–37.
- Fujita, Eishi (1994), 'Toyota seisan hoshiki to rodo/rodo soshiki' ('The Toyota Production System and its Workers/Organization of Work'), Shokugyo Seikatsu Kenkyukai (ed.) *Kigyo shakai to ningen: Toyota no rodo, seikatsu, chiiki* (Corporate Society and People: Work, Living Conditions and Community at Toyota), Horitsu Bunka-sha, Kyoto.
- Grønning, Terje (1992). *Human value and 'competitiveness': On the social organization of production at Toyota Motor Corporation and New United Motor Manufacturing, Inc.* Ritsumeikan University, dissertation for the Ph.D-degree, Kyoto.
- Helling, Jan (1992). *Varldsmestarna*; Utgåva 2 (The World Champions, 2nd Edition). Sellin & partner, Stockholm.
- Japan Auto Industry Survey.*
- Jidosha Soren (Japan Auto Workers' Union) (1990), *Genki no deru jidosha sangyo ankeeto hokokusho* (Report from the Enquete Survey on a Reinvigorated Auto Industry), Jidosha Soren, 1990.
- Kaneda, Hideharu (1991). *Posuto-Toyota hoshiki* (Post-Toyota Production System). Paru Shuppan, Tokyo.
- Kitamura, R. (1990). '21-seki ni te wo nobasu jidosha kojo' ('The Auto Plants Towards the 21th Century'), *Ekonomisuto*, August.
- Kojo Kanri (1990). Vol. 36, no. 6.
- Miyazaki, Shinji (1994), "'Jidosha fukyo" to Toyota no 90-nendai senryaku' ("The Automobile Crisis" and Toyota's Strategies in the 1990s'), Shokugyo

- Seikatsu Kenkyukai (ed.) *Kigyo shakai to ningen: Toyota no rodo, seikatsu, chiiki* (Corporate Society and People: Work, Living Conditions and Community at Toyota), Horitsu Bunka-sha, Kyoto.
- Oyama, Yoichi (ed.) (1985), *Kyodai kigyo taisei to rodosha: Toyota no jirei* (The Giant Corporation and its Workers: The Case of Toyota). Ochanomizu, Tokyo.
- Nikkan Jidosha Shinbun.*
- Nihon Keizai Shinbun.*
- Nikkan Kogyo Shinbun.*
- Nohara, Hikari and Eishi Fujita (eds.) (1989), *Jidosha sangyo to rodosha* (The Automobile Industry and its Workers). Horitsu Bunka-sha, Kyoto.
- Nomura, Masami (1992). 'Farewell to "Toyotism"? Recent Trend of a Japanese Automobile Company', *Mimeo* No. 1992-1, Okayama University, Department of Economics.
- Nomura, Masami (1993). *Toyoteizumu* (Toyotism), Minerva Shobo, Kyoto.
- Ohno, Taichi (1988). *Toyota Production System: Beyond Large-Scale Production*. Productivity Press, Cambridge, MA.
- Press & Data Service (PDS) (1993), *JAIS Annual Corporate Profile: Toyota Motor Corporation*, 1993/94 Edition. PDS International Co., Ltd., Tokyo.
- Tanaka, Hirohide (1982), 'Nihon-teki koyo kanko wo kizuita hitotachi II' ('The People Who Made the Japanese-style Employment Practices II'), *Nihon Rodo Kyokai Zasshi*, nos. 280–282.
- Toyo Keizai.*
- Totsuka, Hideo and Tsutomu Hyodo (eds.) (1991), *Roshi kankei no tenkan to sentaku* (Changing Industrial Relations and Possible Choices), Nihon Hyoronsha, Tokyo.
- Toyoda, Shoichiro (1993), 'Seikatsu kachi wo tsuikyū suru monozukuri no furon-teia' ('The Frontier of a Manufacturing Pursuing Life Values'), *Weekly Toyota*, February 5, 1993, p. 2.
- Toyota Motor Corporation, various documents.
- Toyota Shinbun*, company newspaper now named *Weekly Toyota*.
- Tsuji, Katsuji (1989), 'Jidosha kojo ni okeru "shudan-teki jukuren" no kino-keisei to sono keisei-kiko, 1–3' ('The Formation and Mechanism of "Group Skill" Within the Automobile Plant, 1–3'), in *Ritsumeikan Sangyo Shakai Ronshu*, vol. 24, no. 4 (March), vol. 25, no.2 (September), vol.25, no. 3 (December).
- (1994), 'Toyota kigyo rengo no keisei katei to genjo' ('The Formation Process and Present Situation for the Toyota Corporate Conglomerate'), Shokugyo Seikatsu Kenkyukai (ed.) *Kigyo shakai to ningen: Toyota no rodo, seikatsu, chiiki* (Corporate Society and People: Work, Living Conditions and Community at Toyota), Horitsu Bunka-sha, Kyoto.
- Weekly Toyota*, company newspaper (previously named Toyota Shinbun).
- Winter, Drew (1994), 'Agile Manufacturing: Can it Really Make Big Corporations Nimble?', *Ward's Auto World*, April.
- Wood, S. (1989). 'The Japanese Management Model', *Work and Occupations*, vol. 16, no. 4 (November), pp. 446–460.
- Womack, James P. et al (1990). *The Machine that Changed the World*. Harper Collins, New York.

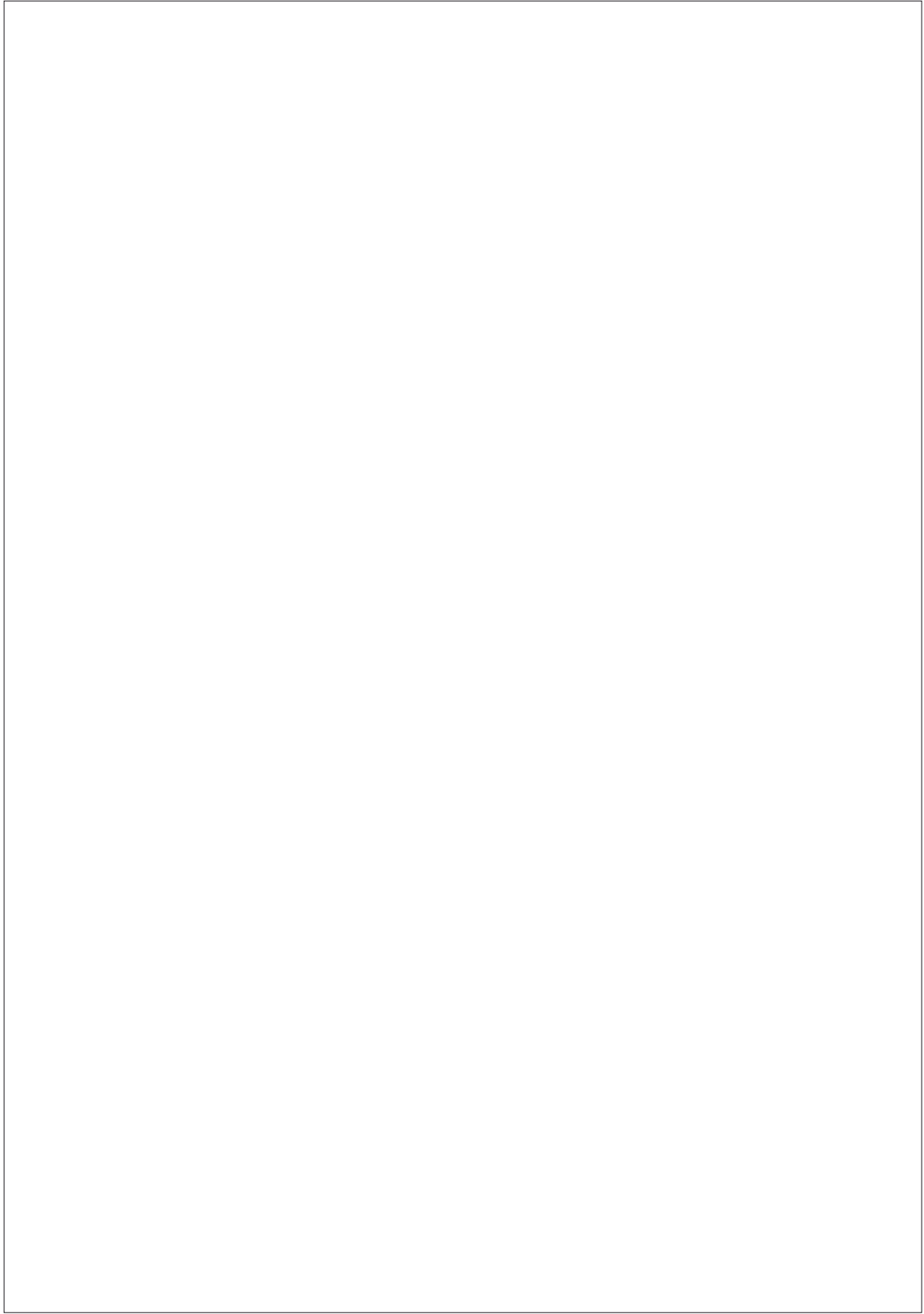

Social preconditions for lean management and its further development

Paul Lilrank

The problem

Lean management was originally developed as an operational response to pressing strategic challenges. In the early 1960s the driving force behind of Japanese manufacturers' management innovations was the threat from US mass manufacturers who were perceived to possess superior technology and unbeatable produced volumes. The challenge was to combine efficiency with flexibility, to compete not only in terms of cost but also in terms of quality, rapid model cycles and variety. For a few decades, Japanese managers focused on operationally oriented strategies, the build-up of organizational capabilities, such as Just-In-Time (JIT) logistics, Total Quality Management (TQM), and Lean Production, to achieve these goals.

Lean production requires a set of soft enablers, that is, social and organizational conditions to match the inherent fragility of the just-in-time-system. Working under lean management is difficult in two ways: it requires fast-paced work closely following standard operating procedures (SOP) and a continuous vigilance to improve the SOPs. Until recently, a 'hardship mentality' has prevailed in Japanese society. Memories of post-war poverty were vivid, social and family values encouraged hard and dedicated work. In such a society, hard work was more easily accepted than in a society where decades of wealth accumulation had softened attitudes towards work.

When pondering the future of lean management in the Japanese auto industry the key question is whether there have been any significant changes in the drivers and the social enablers of lean management.

External challenges can affect the lean system in two ways:

- changes in competition and market conditions can affect the economic drivers of the system; for example, if customers are no longer willing to pay for variety, some of the advantages of lean management are lost.

- changes in society can affect the hegemony of hardship, as a new generation of affluent workers may refuse to put up with the demands of lean production.

Hard challenges to lean production

The current auto industry crisis has been well documented in the Japanese press. In short, the Japanese suffer from low and falling profits with the weakest players deeply in the red, overseas market shares are static or declining, domestic demand is weak, overseas manufacturing operations are slow to break even and a number of product strategies have failed.

The low profitability can be explained by the following factors:

- the strong yen hurts export prices as well as volumes
- the variety wars are taking their toll: during the 1980s Japanese auto manufacturers competed with increasingly broad product lines and a wide variety of versions and options. While the lean factories could handle most of the proliferation, the white-collar sector mushroomed causing heavy non-manufacturing overhead burdens
- a number of models were over-engineered resulting in high prices relative to performance
- many foreign competitors have quickly learned to adopt lean production.

In 1993, after four consecutive years of falling profits, the Japanese manufacturers look less like the management giants they were when *The Machine That Changed The World* was researched and written. The Japanese are facing problems and the Japanese style of management is not likely to survive the recession intact.

However, there is no reason to believe that the lean management system itself, as it operates in the factory, is the source of problems or the first candidate for radical reform.

A major part of the problem is that Toyota, as well as most other Japanese manufacturers, suffer from excessive bureaucracy at the head office which reduces profits. The strength lies in the factories, which work reasonably well as does the marketing. New product development and engineering, though renowned for their short development cycles, are not as effective as is commonly believed.

Another major challenge is that with the exchange rate approaching 100 yen to the dollar, many parts manufacturers lose their competitiveness. The famed keiretsu supplier system is undergoing a structural change. The first-line system suppliers will strengthen their positions while the second and third-tier suppliers will either be forced to close down or move to

cheaper locations. The vertical ties keeping the supplier families together will loosen.

It appears that these problems can be solved with new strategies and a modification of the lean management system. Toyota and others are taking action: variety is cut, model cycles are becoming longer, inventory levels are optimized rather than minimized, new less engineered products, such as the new Mark II, are released, middle-management layers are eliminated and white-collar overtime forcefully cut. To put it simply, the solution is to apply lean production principles also to office work.

Soft challenges to lean production

Another challenge comes from changes in the Japanese society. The ultimate driver is increasing wealth that permits higher average education levels, allows more leisure, fuels higher expectations, and creates jobs and careers in the service sector. In comparison to opportunities elsewhere, even well-paid manufacturing jobs become less attractive than before. During the economic boom (1987–1990) young graduates started to avoid the 3K -jobs (*Kitanai, Kiken, Kitsui* = Dirty, Dangerous, Demanding). There has been a lot of talk about the new generation of Japanese, the *Shinjinrui* (the new human race), that is said to lack all the virtues of their hard-working parents and constitutes a radical challenge to the old ideology.

Ironically, there is a hard component of this challenge: bowing to pressure from their overseas trading partners, Japanese auto manufacturers have promised to cut their average annual working hours from 2 200 to 1 900 by the end of 1993. To the Japanese this is a major challenge, yet in comparison, VW's Wolfsburg plant is set to go down to 1 500 hours.

In comparison with Europe, it should be noticed that the social welfare system is *not* changing, neither is there any significant official departure from the established ideology even though some of the rhetoric has softened. Consequently, whatever dissatisfaction is felt on the shopfloor, it will not show as increasing absenteeism or lack of cooperation, but rather as difficulty in recruiting and high labour turnover. Until approximately mid-1992, Toyota suffered from a shortage of labour and high turnover. Thereafter the recession has halted new hires of temporary shift workers for the first time in 14 years, and reduced the intake of university graduates by 10%. With most major companies reducing the intake of new graduates and letting middle-managers go, the cozy assurance of life-time employment is disappearing and even the *shinjinrui* cannot be as picky as they used to be.

The recession is reinforcing the established order, much in the same way as the oil crisis twenty years ago abruptly closed the debate about whether Toyota should import immigrant labour to man its assembly lines. The hard

times are cooling down the labor market and deflating expectations, thereby slowing down the drivers of change.

The response

Toyota has been relatively quick to respond to challenges. In the following, the main lines of action are described.

From maximizing to optimizing: robust manufacturing systems

After the death of Taiichi Ohno, the crusade against work-in-progress (WIP) inventories has cooled down, and quite reasonably so. The waste reduction drive has reached its logical limits: the trade-off between inventory on one hand and fragility and stress on the other has been recognized. Now inventories are slightly increased to optimize the benefits and costs of lean management.

It is worth noticing that in this context stress is openly recognized as a major problem calling for more robust arrangements. However, Toyota officials – very much in line with the ideology – interpret stress not as arising from hard repetitive labor, but from the mental stress stemming from the notion that a small disturbance may cause the whole factory to come to a stop. This would obviously lead to production loss, a small erosion of the wealth base, and a loss of face and feelings of shame to those responsible. Toyota systematically uses shame as a stick to motivate middle managers. At the Tahara plant which produces the Lexus an extra final inspection called The Customer Satisfaction Line has been implemented to assure perfect quality. Whenever a defect is found, the origin of it is located and the inspector goes to the intercom and announces for everyone to hear that ‘would Mr. Suzuki of XYZ section immediately come over, we have found a defect of yours ...’!

Simultaneously, JIT deliveries have become problematic because trucks shuttling back and forth between assembly lines and parts manufacturers several times a day clog the notoriously weak road system in Japan. With increased use of foreign parts–purchased to relieve trade friction – and relocation of plants outside the Aichi prefecture, WIP inventories had to grow slightly, adding a bit of buffers to relieve mental stress. This has been prematurely interpreted as the end of JIT; more correct is to describe it as an adjustment, that comes at a time when the waste-minimization drive has reached its natural limits. A number of arrangements have been devised to cope with the problem: cooperative load sharing system, a parts distribution center with one to two days of inventory, and daily sea transports from Aichi to the new plant in Kyushu (Watanabe 1993).

Coming out from the Aichi Prefecture

In 1990 Toyota announced it will break 'the Monroe Doctrine of Aichi Prefecture' and establish three new manufacturing locations in Japan: the Miyata plant in Kyushu for final assembly, and plants in Hokkaido and Tohoku for some key components. The reasons given for this radical break with tradition were the need to overcome labour shortage and to build better working environments, and to experiment with new concepts at greenfield sites (Watanabe 1993, 80).

The Miyata Plant, which came on stream in early 1993, is the prime experimental plant in work organization, production, and parts supply systems. It has an assembly capacity of 100,000 vehicles per annum with one shift. It is currently producing only one model, the Mark II, and expected to make, at most, only three similar passenger models in the near future. The production of Mark II moved to Miyata from Motomachi, the first and oldest assembly plant that incorporated decades of continuous improvement. This move signifies a need for changes more radical than can be achieved with the traditional *kaizen*, continuous small-step improvement approach.

For obvious reasons the experimentation going on in Miyata is not well documented. Watanabe (1993) gives the following outline of measures labeled the '*hito ni yasashii*' -line, meaning being nice to the people.

- Even at full capacity, only two shifts will be used (first shift 0600–1450; second shift 1550–2350).
- An increasing number of females will be hired, up to five percent of the workforce, but they may leave their shift 2200 to comply with the law restricting female night work.
- Use 'easy' lines for elderly workers and low-stress sub-assembly lines for part-time workers.
- Job sharing: two persons may share one job.
- Better welfare amenities such as locker rooms, showers, canteens; Toyota as a whole plans to invest 100 billion yen in amenities during the five-year period starting 1991.

It is recognized, however, that the '*Hito ni Yasashii*'-line will not solve the problems. In the long run, automation of simple manual labor is the key solution. In the short term, the key is how to plan and implement appropriate levels of automation so that it fits with other objectives.

The Miyata plant is less automated than Tahara. Very much in line with the established ideology, the managing director of Toyota, Mr. Yanogawa, made the following statement during the planning stage of the Miyata plant: 'Planned full automation is expensive and resented by workers. We want to introduce simple, friendly automation. Then, after a while, workers will rack their brains and have fun figuring out new ways of automation.'

Kyushu will be a plant that is built on a continuous stream of ideas from the workers.’ (Nikkei Business 1992) In other words, Toyota has spent the past three decades involving workers in planning and implementation of JIT-manufacturing; now the challenge is to do the same with automation.

The lean office

The most serious challenge facing Toyota, and other Japanese manufacturers, is to apply the lean principles in offices to streamline excessive administrative procedures.

The bad and worsening profitability of Japanese auto manufacturers can be partly explained by variety-based product strategies, resulting in short model cycles and a proliferation of parts, models and options. While the factories were able to handle the increased complexity, the offices were not: during the decade from 1982 to 1991, Toyota increased its blue-collar labor count by 18 percent to cope with a 20 percent increase in unit volume and a doubling of revenues, while the number of white collars increased 45 percent. For every factory worker hired, 2.5 office workers were added. While production is continuously rationalized, staff functions and R&D are very wasteful. ‘If white collars can’t become lean, Toyota won’t be strong’, says Mr. Katsumi Ohnishi, Vice President at Toyota (Nikkei Business 1.4.1993, p.13).

The famed lean product development is apparently not as efficient as believed. It has demonstrated its ability to get products out the door fast, but not cheaply. The new product development team leaders, the *Shusha* ‘super craftsmen’ began increasing the number of custom designed parts without consideration of synergy across models. In October 1992 engineering and R&D were radically revamped for the first time. Three major product development clusters were created: FF (front engine, front drive), FR (front engine, rear drive) and CV (commercial vehicles). The aim is to increase the number of commonly used parts and designs within each cluster.

In production plants working hours have been reduced by 100 hours per year since 1991. In offices, despite calls for voluntary action, no results were achieved until in November and December 1992 white collar overtime was drastically reduced to zero despite massive protests from the employees.

Already in 1989 Toyota announced it will eliminate a layer of middle managers, the *kacho* (section chief) rank. Instead, flatter administrative hierarchies with only one level beneath the department manager (*bucho*), called Staff Leader, were created. The old multilayered hierarchy lives on as a competence scale, removed from the administrative hierarchy. Parallel hierarchies as such are nothing new. For example, blue collar workers in the Japanese steel industry have traditionally been ranked on an elaborated competence hierarchy with up to a dozen different levels. Reaching a cer-

tain level formally qualifies for a position in the administrative hierarchy, such as a foreman, but does not guarantee it. Indeed, the system is similar to that found at most universities. A competence hierarchy consisting of undergraduates, graduates, Ph.D. candidates and post-doctoral students is well established but the administrative hierarchy with professors, heads of departments and deans is separate.

The new Toyota system has apparently been slow to get rooted, as old habits die hard. However, the real significance of Toyota's flatter hierarchy is that for the first time, white collar work is beginning to be subject to organizational reforms implemented in the blue collar sector already decades ago. The real challenge to both lean management and Japan's future as a leading industrial nation is whether this will work.

Conclusions

In the early 1990s, during the closing years of the economic boom, it looked like Toyota would be facing the same problems that Volvo encountered some twenty years earlier. The question was whether Toyota would be forced to implement Kalmar/Uddevalla -types of solutions. At the time of writing, fall of 1993, the answer must be an emphatic no; at least not for the rest of the decade. External and internal forces will move Toyota to take a number of actions, but none of them lies in the direction the Swedish plants have taken.

The challenges facing Toyota are different: there is no welfare state eroding the willingness to work among those who remain on the payroll. Turnover among line workers can be handled as it always has been; the recession and increasing unemployment serve as a strong reminder to the *Shinjinrui* that wealth must constantly be recreated. Shorter working hours can be managed within the system – they may also be a blessing in disguise forcing the ideology to move a bit from glorifying hard work to valuing smart work. Labour shortage will ease as some production moves out from the Aichi prefecture – it is not a permanent solution, but should be satisfactory for the rest of the decade. By the turn of the century, automation will have eroded a part of the problem.

The Toyota production system offers workable solutions to the problems of monotony and stress starting from its own premises. The challenge of automation will provide ample opportunities to creative problem solving involving line workers. While the Japanese have taken a page from the Swedish book in recognizing the need to 'be nice to people', it is only one, and a minor, solution to the problems. In a world where *jiriki* (self-reliance) and *jishusei* (internal motivation) are still accepted as hegemonistic values, management can throw the ball back to workers: 'well, if you think this work is boring, then let's figure out a way to automate it away'.

The Japanese solution to the boredom and stress of mass assembly is to downplay the Taylorian distinction between thinking and doing without radically changing the formal organization and management prerogatives. On the factory floor, workers are requested to diligently follow standard operating procedures (SOP) while at the same time encouraged to actively participate in rethinking and improving the very same procedures. Organizational arrangements, such as Quality Control Circles, suggestion systems, study groups, and quality audits are created to support this effort. While the workers are free to tinker with alternative solutions, the final decision to change a SOP is taken by the appropriate manager.

Formal organization is less important in Japan than in Sweden: continuous improvement can live side by side with a strict formal hierarchy. Mixing conformance to standard operating procedures with team-based improvement activities of those same procedures, the Japanese can play with a wide range of possible solutions without radically changing the basic logic of production. Swedes are limited to playing with the formal organization of work because there is no tradition of informal mixing of improvement with following of rules.

Are the Japanese learning something from Sweden and Uddevalla? The Volvo experiments are certainly recognized, but in various ways. Morinobe (1989) uses Volvo as a warning example where you end up when pampering people.

Watanabe (1993) admits that Volvo has made significant progress in making work more humane. The Kalmar model could be an ideal factory system for producing high-margin, small volume cars. Honda is already doing that very thing at its Tochigi Plant, where some 300 people are building 25 NSX sports cars per month, each worker performing the tasks of 20 to 30 traditional assembly line operators. It would be nice if all auto industry work could be organized like this, writes Watanabe, but unfortunately it is not feasible in the Japanese competitive context, and certainly not in the near future, when the overriding concern is to restore the profitability of the Japanese auto industry.

References

- Clark, Kim B. and Takahiro Fujimoto (1991), *Product Development Performance. Strategy, Organization, and Management in the World Auto Industry*. Harvard Business School Press, Boston, Massachusetts.
- Lillrank, Paul and Noriaki Kano (1989), *Continuous Improvement – Quality Control Circles in Japanese Industry*, Michigan University Center for Japanese Studies Publications, Ann Arbor.
- Monden, Yasuhiro (1993), *Toyota Management System, Linking the Seven Key Functional Areas*, Productivity Press, Cambridge, Mass.
- Morinobe, Eijiro (1989), *Toyota no Jinzai Senryaku* (Toyota's Personnel Strategy), Daiamondo-sha, Tokyo 1989
- Nikkei Business (July 19. 1993), 'Katsuryoku o hikidasu soshikikakushin – Rienginiaringu Gannen' (The organizational revolution for vitality – The Year Zero of Reengineering), *Nikkei Business*, pp. 10–24
- (January 4. 1993), 'Toyota no Sentaku' (Toyota's Choice), *Nikkei Business* pp.10–23
- Ohno, Taiichi (1988), *Toyota Production System: Beyond Large-Scale Production.*, Productivity Press, Cambridge, M.A.
- Omichi, Yasunori (1993), 'Adjustments in Car Industry Required.', *Journal of Japanese Trade and Industry*, No 4, pp.12–15.
- Shimokawa, Koichi (1993), 'The Auto Industry Enters an Era of Restructuring and Globalization.', *Journal of Japanese Trade and Industry*, No 4, pp.8–18.
- Toyo Keizai (May 1.1993), 'Nihonteki Keiei no Shi to Saisei' (The Death and Rebirth of Japanese management), *Shukan Toyo Keizai*, Tokushu pp.8–21.
- (April 24. 1993), 'Shushin Koyo no Genso' (The illusion of life time employment), *Shukan Toyo Keizai*, pp.8–24.
- Watanabe, Yoshihiro (1992), *Toyota ga Nihon o Kaeruka* (Will Toyota Change Japan?), Nikkan Shobo, Tokyo.
- Womack, James P., Daniel T. Jones & Daniel Roos (1990), *The Machine that Changed the World*, Rawson Associates, New York.
- Yasuda, Yuzo (1990), *Toyota no Soikufu Teiankatsudo* (Toyota's Suggestion System for Creative Improvement), Nihon Noritsukyokai, Tokyo.

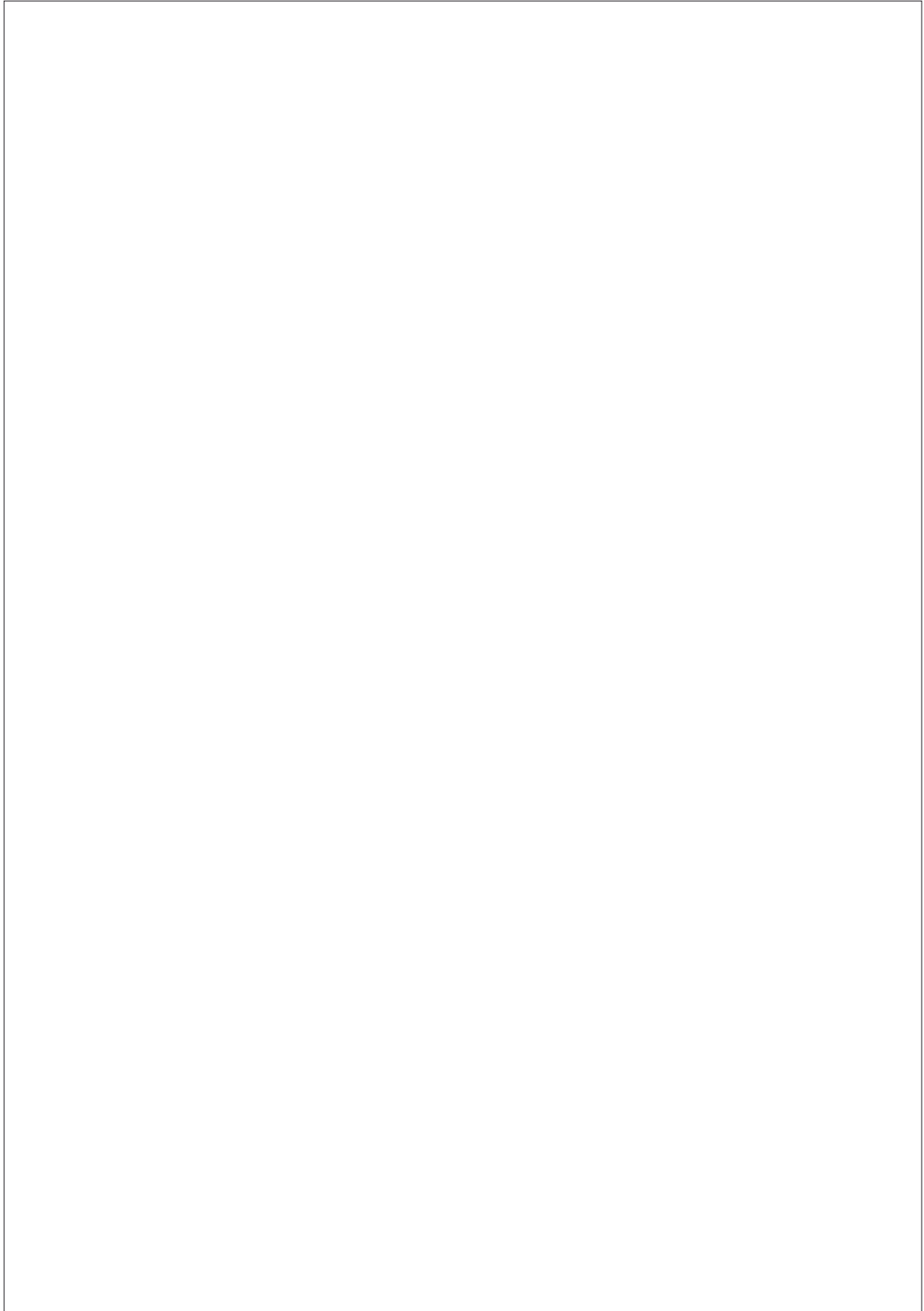

Lean production

The Micro-Macro dimension,
employment and the welfare state

Peter Auer

1. Introduction

Volvo's Uddevalla Factory is unique in that its production system is not based on the assembly line principle ... A majority of the Group's production units are working with programs in the work-life area. The most far reaching approaches are applied in Volvo's new plants ... As a whole, these programs will increase the satisfaction employees derive from their jobs thereby resulting in more efficient operations (Volvo, 1989, p. 12, p. 61).

The comprehensive rationalization programme that was initiated in 1990 continued throughout 1992. The objective is to achieve cost-effective production with shorter lead times, higher quality and improved delivery reliability ... the assembly plants in Uddevalla and Kalmar are being closed down ... Since mid-1990 the number of employees has been reduced by approximately 6,500. Decisions regarding further reductions in the number of employees were made in November of 1992. The substantial reductions in personnel have placed Volvo companies in situations that they have not dealt with earlier (Volvo, 1992, p. 12, p. 61).

Only three years interval separate these two statements. But, more than merely indicating the difference between announcements of a company in boom times and in bust times, the difference between these two statements indicates that a fundamental change has taken place in the organisation of production of a major car company, known for its human centred work organisation. A new model has emerged which shakes the foundations of industrial (and also service) production: lean forms of organisation replace traditional forms of organisation. Volvo, all in all a small player in the world automobile industry, does not stand alone in this change. All major

companies in Europe are presently engaged in large scale rationalisation to streamline their organisation and reduce their costs to arrive at 'lean employment'.

Does this development also indicate that the humanized work organisation along the lines of an European, socio-technical model is incompatible with the rough world of ever increasing competitive pressure? Has the idea of the 'fathers' of the socio technical model (Trist and Bamforth, 1951; Thorsrud and Emery, 1964) that job satisfaction through new forms of work organisation is indeed a necessary condition for efficient production to be dismissed because of the new requirements of production in the face of Japanese competition? Although the authors of the now basic reference for 'lean production' Womack, Jones and Roos (1990) (hereafter WJR) contend that the lean world is 'the best of all possible worlds' and unites rationalisation and humanisation, the former seems – after a struggle of about 20 years – clearly have taken the lead over the latter and might even have won by knock-out, resulting in employment cuts of unknown dimensions especially in countries like Sweden and Germany, known as the most advanced models of 'welfare' production, with high wage, employment and social security levels.

It has to be asked if there is an alternative to the lean approach and if there is still room for some 'fat' in production, despite all the pressures in the opposite direction. We think indeed that there is an economic (and not only social) rationale to retain some fat, which appears if one is to consider the impact of micro (company) decisions on the economy as a whole.

The following article is written not only from the perspective of organisational change itself, but also considers the linkages between organisational change and employment: a topic so far widely neglected in the literature on industrial sociology or industrial relations. However, in the understanding of the author, the consequences for employment of the present rationalisation strategies – which are not exclusive to the automotive industry – have to be questioned and solutions have to be found, which permit competitiveness without endangering the whole network of social protection of the advanced industrial countries.

This paper will provide a rough overview of present organisational change and discusses the links between internal and external adjustment of the workforce and the extent of (estimated) overmanning and manpower cuts. Differing workforce adjustment patterns in four European countries in the recent past as well as the institutional embeddedness of these adjustments will also be discussed. Finally, some ideas on how to combine reasonable lean organisation with reasonable employment levels are proposed.

2. Towards a new work organisation model

Few would deny that there is widespread change in the European automotive industry and that since the late 80s this change is, in one way or the other, influenced by Japanese practices. The book 'The machine that changed the world' by WJR is today a basic reference: It has had a large impact on management circles within the European automobile industry and illustrates the lead of the best practice Japanese firms opposed to the inferior position of leading European manufacturers in assembly productivity. Cooke (1993), shows the impact on Germany, where most major car companies bought 'thousand of copies' for reference as 'a bible for top management'.

However, changes are far from being introduced in an even manner. Take Volvo, where the work group has become an institution: There the situation varies from plant to plant: Uddevalla has dropped the assembly line principle, Kalmar has dropped the assembly line, but kept the principle of centrally paced sequential flow (before closure decision for capacity reasons were taken for both plants) and Torslanda and Ghent have kept assembly lines. Some producers have in some factories 'doubled' the assembly line with group working stations to assemble special vehicles (Mercedes Benz, Volkswagen and others). Three German manufacturers have established new factories (Opel and Volkswagen in the ex-GDR, Mercedes Benz in Rastatt), which have all introduced group work, JIT (just in time), and Kaizen (continuous improvements), in various forms. Mercedes has established one of the most modern final assembly plants in Rastatt which is also based on the now defunct Swedish experiences and where production organisation is a mixture of Uddevalla, Kalmar and local German technical approach with some Japanese ingredients.

The level of automation also varies with each manufacturer. With few exceptions manufacturers have automated their body shops so that body welding is nowadays an almost completely automatic process and differences between firms amount to a few percentage points in the degree of automation. More differences can be found in paint shops and especially in final assembly, where still many barriers for automation do exist. Some manufacturers implemented automation of the final assembly for large series, such as Fiat for the Tipo and Volkswagen for the Golf. At the other end of the spectrum, Mercedes has, on the whole, stuck to manual assembly lines and is proud that it runs only one industrial robot at Rastatt. One finds today 'automation islands' in all final assembly plants, where tasks like body/motor marriage, seat, wheel and windshield fixing are carried out automatically. However, after attempts to maximise automation, today, a more careful approach is the rule, even in the newest Japanese Assembly plants.

Concerning operator autonomy, the number of layers of hierarchy, the

level of equipment flexibility and the amount of time equipment is used, a general rule is that production units become more responsible for costs and quality of their products, hierarchies are becoming flatter (even in the formerly very hierarchical french firms) equipment more flexible (as to allow simultaneous operations on different models or variants of cars) and shift systems are introduced everywhere to allow for intensive use of equipment. Also as far as the relationship between manufacturers and suppliers is concerned, there are similarities in developments like the increase in outsourcing and globalisation of supply while reducing the number of 'first tier' suppliers which will in future deliver whole 'modulized' systems (and arrange their own network of second and third tier suppliers). But in all these dimensions differences remain: sometimes hierarchies have only three layers, sometimes more. Sometimes far reaching cost accountancy is introduced at low levels of the organisation, sometimes it is not, in some European factories continuous shift work or night shifts are introduced, in others not. Some of the manufacturers will rely in the future on only a few main suppliers, some – while reducing their overall number – will cope with more (for example, Volkswagen will go from 950 to 100 while Mercedes will go from 1,100 to 550 and Ford from 900 to 600). Despite common trends and a fair degree of similarity in goals large differences have and will remain. Some of this differences have to do with production volume (e.g., the difference between high and low volume producers) some with the age of a factory (old sites vs. green field sites). Others have to do with the firm specific business cycle, the labour market situation (tight or loose) and industrial relations (changes depending for example on the bargaining power of the unions). In the final analysis, despite common trends and the introduction of such policies as 'Just-in-time', 'Kaizen', 'Total Quality', 'Group work', 'Profit (or Cost) centers', 'Outsourcing', etc., there is still a fairly wide spectrum of different practices in work and production organisation across countries, companies and individual plants (Turner and Auer, 1992).

It might be one of the paradoxes of organisational change that unions turned work organisation changes into an important policy issue just when the 'lean production' concept made its successful entry in management. But it is clear that while unions do not oppose efficiency, their goals are different from that of management. For management, efficient production in a competitive world remains the main goal, whereas unions have to fight also for the maintenance of the acquired rights of their constituencies. Because their constituencies are being endangered by the lean, cost reduction approach it might well be that the coalition between reformist management and unions in regard to work organisation which prevailed up to the early 90s (see Kern and Schumann, 1984; Auer and Riegler, 1990) will not survive in the era of

lean production if no solutions to the employment problem are found. The only chance for conflicts not arising overtly is the present vagueness of the concept of lean production under which, with some efforts, even former human centred work organisation concepts can be subsumed. The diversity of actual situations on the shop floors contribute to this vagueness and the fact that employment cuts caused by organisational change cannot be easily divided by those stemming from overcapacity, has also its impact.

However, despite all the differences, there is something in common to all European manufacturers and this is troublesome for workers and trade unions, as well as for those managers brought up in the cooperative and 'humanisation of work' spirit of change of the 80s. It is also disturbing for all those concerned with the problems of employment and unemployment: all manufacturers try to get leaner and try to reduce their costs. This places a tremendous amount of pressure on their major suppliers which will in turn direct this pressure towards their lower tier suppliers. This will lead to reductions in manpower levels everywhere, even if future demand will increase.

3. Internal and external adjustment: friends or foes?

The situation of the European automobile industry compared to the Japanese automobile industry seems to be that in Europe both internal adjustment through lean forms of organisation and external adjustments to reduce the labour force are required, whereas in Japan lean form of organisation match with lean levels of employment. In this context, it becomes more and more important that companies engage in what could be called 'managed redundancy' policy. These policies comprise an array of measures of internal (internal transfers, internal training, short time work, etc.) and external adjustments (attrition, external transfers helped by company based placement units and training programmes, redundancy payments, early retirement schemes, etc.). They permit to lower workforce levels without disrupting totally 'corporate cultures' – important for having a motivated workforce, willing to be flexibly allocated to different tasks – and are already an important issue of bargaining which will gain in importance in the future. As workforce adjustment is not a new issue, the following chapter looks at the ways in which it was managed in the past. Four countries with different patterns (Sweden, Germany, France and the UK), have been selected. Before a short presentation of the experiences of these countries, the issue of why employment security seems to be important for efficient production, is discussed.

3.1 Employment security and internal change

The cooperative attitude of Japanese employees and their labour unions

and their very strong identification with the destiny of their firm, are not conceded without certain things in return. The most important one is undoubtedly the employment security large firms in the automobile sector offer their employees, and the management of their internal labour markets, where salary (and promotion) is based on seniority and continuous training. The three pillars of Japanese management (employment for life, salary based on seniority – which goes together with training and evaluation – and enterprise labour unions, see Inagami, 1988) although now shaken by a prolonged recession, seem still to hold.

It is interesting to see how this trade-off between acceptance of internal adjustments, industrial peace, identification with corporate strategies and employment security, has spread to other national contexts through Japanese transplants or joint ventures.

The principle of trading greater internal flexibility for less external flexibility, through greater employment security is one of the cornerstones of the Japanese 'model'. However, as has been related by many authors, in Japan, external flexibility is ensured through less employment stability among smaller subcontractors, through inter-company transfers (*shukko*) mainly for older employees which often are a 'functional equivalent' to European type of early retirement provision. It is this 'extended internal labor market', including suppliers and helped by subsidised short-time work and training during economic downturns, which explains much of the employment system in Japanese plants (Inagami, 1988; Auer 1994). In Japan, clearly, internal adjustment is preferred to external adjustment.

If we look at employment development over a long period, we can see that, compared to other geographic regions, employment in the Japanese automobile industry including those subcontractors classified as belonging to the motor vehicle sector fluctuates much less than in the American automobile industry. Also employment increased until 1990, which contrasts with the experience in the two other regions (figure 1).

3.1.1 Internal management in a context of unstable employment?

Europe is, as we have already said, disadvantaged in relation to Japan: on the one hand, it will have to push through internal adjustment through changes in work organisation and the development of human resources, to face technological changes and catch up with the Japanese, and on the other hand, its workforce will have to 'lose weight' to achieve 'leaner' production. Yet in a lean organisation, technical and human faults are felt 'on line', and production becomes more fragile. Therefore, skilled labour is required, who are able to act quickly in case of failures and work without making errors. But if a major investment in personnel is made (and this is presently the case as further training is becoming increasingly important), while lean

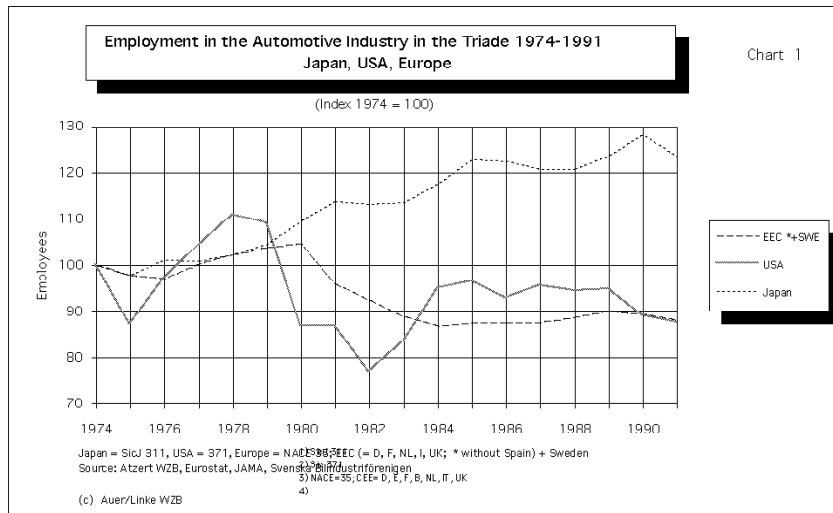

Figure 1

production leads to dismissals, a dilemma is reached: The commitment to and motivation for sustained qualitative internal adjustment seems to be easier, as the Japanese example shows, if there is a certain degree of employment security. Womack, Jones and Roos (1990) noted in their book that the hesitation to express your know-how and commit yourself '... would lead directly to catastrophe in the Ohno plant' and that 'the high work morale in the Takaoka plant was probably due to the fact that all workers had life employment in exchange for their commitment' (1990, p. 58, 84).

If there is no development of the market to counterbalance the effects of rationalisation and such markets are yet not in sight, the European automobile industry will steer somewhere between Charybdis (massive layoffs – and have difficulties making internal changes and get trained labour), and Scylla (have too high labour costs and be disadvantaged in competition). In any case, it won't be easy going. A substantial segment of industrial employment is concerned: aside from the automobile industry (manufacturers and equipment makers), which in 1992 represents more than 8 percent of all jobs in EEC manufacturing, there are other dependant sectors (repairs, insurance, shipping, etc.). It is estimated that 10 percent of total employment in the economies of the major car producing countries, is directly or indirectly associated with the automotive sector (CCFA, 1992; JAMA, 1993).

3.2 The level of over-employment

The figures given are not reassuring and there is hardly a day without announcement of planned lay-offs by one of the automotive companies in Europe. Without additional outlets, and with a productivity similar to that of its Japanese counterpart, the European automobile industry can only continue to employ half its workforce (WJR, 1990). Mc Kinsey estimated that as many as 700,000 jobs could disappear in Europe in the coming years. The declarations made by European automobile executives for future employment levels are not optimistic either. There are, of course, many uncertainties concerning the development of the market, and such uncertainties will increase with the opening of new markets in Eastern Europe, which have already (temporarily) spurred the German and French automobile industry. One should also remember that during the first oil crisis in 1973–74, massive layoffs were predicted, as well as the disappearance of many manufacturers in the then near future. But aside from the UK where more than 55 percent of all auto jobs (and more than 30 percent of production since 1974), were lost in 1991, the automobile industry weathered the storm quite well.

In fact, no one knows in which countries most of the layoffs will take place. Different sources come to different results: according to Morgan Stanley among European manufacturers, France and Italy – whose market share is said to be shrinking by roughly 3 percent, from now to 1995, to the benefit of the Japanese (+5 percent) – are more directly concerned, whereas Germany (VW, AUDI, Opel) should increase its market share for new cars by +1 percent by 1995. It is probable that the European countries whose automobile markets are the most protected against Japanese imports, i.e., Italy and France, will be the ones to suffer the most when the market opens after the year 2000. But all is dependant up on how ‘managed’ this trade will remain. A European Commission study (EEC, 1990) which measured the effects of European integration within 40 ‘sensitive’ economic sectors (taking foreign trade into account), showed that the automobile industries of Germany and Spain, and also to a lesser degree France, are in very good competitive positions, and that the United Kingdom, Italy, and the Netherlands are in bad positions (especially with relation to countries outside the EEC such as Japan). To this it must be added that manufacturers such as Volvo and Saab, which sell a large part of their output on the highly competitive American market, suffered greatly from the Japanese competition in the top-of-the-line range there.

However, it seems that those countries which have had up to now very high employment levels, such as the German manufacturers are increasingly concerned by cuts in their workforce: All in all about 11 percent of all auto-jobs disappeared in Germany in 1993. Observers judge this numbers to be insufficient and estimate that in Germany alone, suppliers and manufactur-

ers together could loose as many as 200,000 to 300,000 jobs by 1995 (*Die Zeit*, No. 12, March 1993).

Where will jobs be cut: among manufacturers, among equipment makers, or both? Table 1 shows job distribution between equipment makers and manufacturers in 1987 and 1991.

Table 1
Employment Distribution among Manufacturers and Suppliers
(in percent of total)*

	<i>Europe</i> ¹⁾		<i>USA</i>		<i>Japan</i>	
	1987	1991	1987	1991	1987	1991
with manufacturers	67.5	66.7	45.0	44.2	27.4	25.8
with suppliers	32.5	33.3	55.0	55.8	72.6	74.2

* total = NACE 351 (construction and assembly of motor vehicles and engines and NACE 353 (production of motor vehicle parts and accessories) (US = Sic 3711 and 3714; Japan = SicJ 3111 and 3113)

1) Germany, France, Italy, UK

Sources: VDA; US Department of Labor; Statistisches Bundesamt, Fachserie 4; own calculations.

The three regions of the triad show very different types of distribution between manufacturers and suppliers. In Japan (and to a lesser degree in the US) the majority of the workforce is working for suppliers, whereas in Europe most employees work with manufacturers. This distribution patterns are consistent with the degree of subcontracting which is much higher in a typical Japanese plant than in an European plant.

In all regions (Japan included), the trend is clear. As a share of total automotive employment, employment of manufacturers is decreasing, whereas employment of suppliers is increasing. Especially in Europe, one can expect most job cuts by manufacturers, as the potential of subcontracting seems far from being exhausted. This does not mean that the jobs lost by manufacturers are simply transferred to suppliers, as the suppliers themselves are being pushed into hard rationalisation programmes to produce at low costs by their costumers. The distribution balance on the whole will be skewed towards supplier employment but still fewer jobs than before, at the end of the day.

3.3 Employment trends in Europe since 1974

Between 1978 and 1985 (the same number of years as those remaining

between now and the year 2000) 350,000 auto jobs were lost in countries which registered job losses during this period. This was higher than that of the European steel industry, which cut 265,000 jobs over the same period. This means that a fairly massive readjustment of the workforce is not a new phenomenon for the automobile industry or for European industry in general. But there are great contrasts between the different countries: the UK alone accounts for 57 percent of all job cuts in the automobile industry. Furthermore, aside from the quantitative aspect, over-employment was managed differently in different European countries, which is explained by their different socio-economic models. The subsequent analysis of the different countries patterns of workforce adjustment, concerns primarily the period after the first 'oil shock' to just before the end of the recovery (1989).

3.4 Four different ways to adjust employment

We have plotted the different performances of four countries in chart 2. Two countries succeeded in creating jobs during the period, and two others suffered job cuts. It seems clear that the need to adjust employment is primarily determined by economic development and the strength of the automobile branch in the world market. There is a relationship between production and employment (see figure 3), though this relationship is much looser in France and the UK, than in West Germany and Sweden.¹ This shows that, while in the final analysis, management of the workforce is a function of production and the market, it also depends on employer, labour union and government strategies, i.e., the power balance in the system of industrial relations. Employment is a political as well as, an economic issue. Since the balance of power is governed by institutions such as the Labour Law (the regulation of employment protection: see Auer et al., 1992; Büchtemann and Meager, 1991; Mosley, 1993), employment and training policies, etc., a filter exists between adjustment requirements determined by market changes and the actual adjustments. For economists of the pure neoclassical tradition, this is a distortion of market forces as employment should not be affected by social or political factors. For supporters of the 'institutionalist' approach, the intervention of the industrial relations system can provide a buffer against the abnormal functioning of the market and regulate employment levels more efficient as the market. For some authors, the existence of strong institutions makes it possible to implement post-Taylor or post-Fordist production models, and is a prerequisite for economic growth, since strategies for mass-producing low-quality goods, requiring cheap unskilled labour are no longer adapted to the current expectations of consumers. Therefore, strong institutions support a 'diversified quality production' in a high skill, high wage economy (Streeck, 1991).

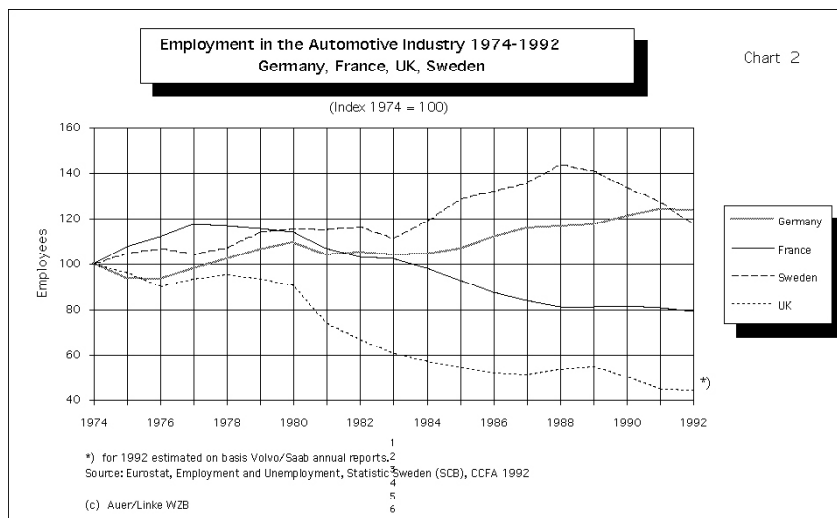

Figure 2

3.4.1 'Neo-corporatist' countries maintained a high level of employment

Up to very recently, there seems to be reason to believe Streecks arguments: chart 2 shows that employment has fared, up to the 90s, better in countries with 'neo-corporatist' type social relations and strong labour unions than in countries with more conflictual industrial relations and weak or weakened labour unions. Furthermore, the former increased their output fairly quickly after the two oil crises and took advantage of the subsequent recoveries by concentrating on the top-of-the-line range. This also holds true for industry in general, and particularly for the steel industry, where they cut fewer jobs over a longer period than the two other countries, and production was redirected towards special steels (Semlinger, 1991; Riegler, 1992).

Germany and Sweden have strong labour unions and employers' associations and a tradition of communicating between social partners at different levels, as a result of deals which include industrial peace clauses. Therefore, strikes are rare but can be serious and widespread, as during the struggle for a 35-hour work week in Germany. In both countries, the trend towards decentralisation in bargaining, although affecting the labour unions, has not weakened them to the same degree as in the UK or France, thanks to strong institutions at enterprise level. Employment is certainly not 'guaranteed', but it is protected by legislation against lay offs and agreements to counter the effects of rationalisation (*Rationalisierungsschutzabkommen* in West Germany). It must be said that large companies in the automobile industry have developed 'internal labour markets' with their own recruitment, career and redundancy rules, which come close to employment security for workers with unlimited employment contracts. Compared to France, they make less

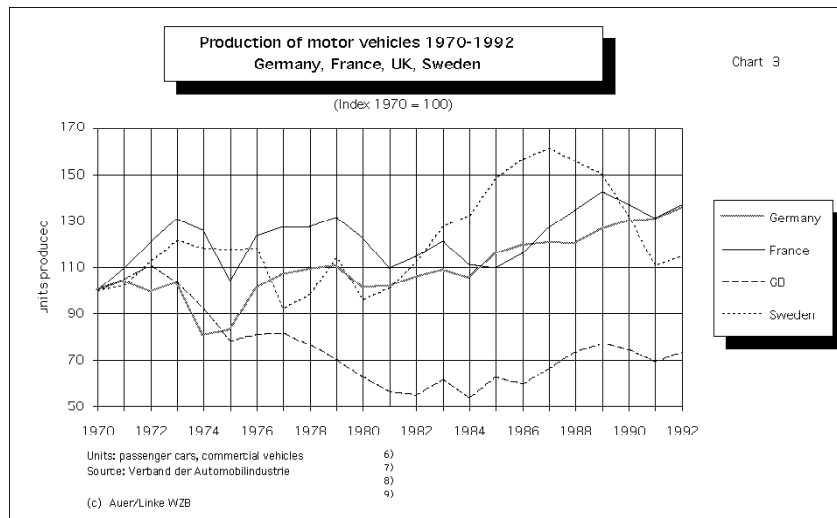

Figure 3

use of fixed term contracts and temporary workers (Auer and Büchtemann, 1990). But they do not ensure this 'employment security' alone: they are assisted, when needed, by measures financed in part by the government. In West Germany, short-time work was heavily used during drops in demand: in 1974, 14.5 percent of workers in the automobile industry were on short-time work, and during the second oil crisis, the figure was 7 percent on average. Short-time work is used in Sweden along with subsidies for training on the site of employment during slow growth periods.

The Freezing of hiring and use of attrition make it possible to avoid lay offs. In the automobile industries of both countries, but more in Sweden than in Germany (where departing employees often receive severance pay: *Aufhebungsverträge*), adjustments were made easier thanks to a fairly high turnover (and therefore voluntary departures), even though there are fewer departures during economic slumps. The fairly high level of mobility and the return of activity enabled the renewal of personnel, but at the same time, underlined the tightness of local labour markets.

In both countries, though much more in West Germany than in Sweden, the early retirement solution (partially paid for by public funds) was used. In West Germany, where immigrant labour is laid off more than German labour, 'expatriation grants' together with facilities to recover pension funds, were proposed temporarily to immigrant workers who accepted to return to their home countries. For both countries, the decrease in work time has also supported employment: in Germany, the working week was significantly shortened through collective bargaining (37 hours by now and probably 35

hours in 1995). In Sweden, where the working week remains the same, for example, it is still 41 hours at Volvo, the numerous possibilities for legal absence (parental leave, training leave, etc.), have decreased the effective time worked to one of the lowest in Europe. Different shift systems have also been introduced in both countries which allow a longer use of equipment.

While there are many differences between the two countries, internal adjustments were favored over external adjustments, and there was job stability for a large 'core' of employees with substantial seniority, which is still encouraged by a solid 'institutional environment'. This employment stability (relative because of turnover), was put to the test during the two oil crises but was not seriously threatened, and with the recovery up to the 90s, the lack of qualified labour sometimes became even more of a problem than ensuring employment stability. This has changed with the present recession together with changes towards the 'lean' company.

3.4.2 Market vs. State: employment adjustment in the UK and France

This 'institutional environment' is different in the UK and France who have more conflictual industrial relations, even if changes can currently be noted. True, there are major differences between the way the UK and France approach layoffs: France, with the help of the government, is a case of 'managed exits' with accompanying measures largely paid for by the public, while the UK is a case of neo-liberal market led adjustment.

Adjustment by the market. In the UK, after 1979, the very liberal policy of adjustments by the market became a key issue in the battle against what was considered an ineffective 'over-manned' industry and was also part of a strategy against labour unions and against certain institutional rules laid down earlier to protect jobs (such as the 'guaranteed week' agreements, a sort of short-time working scheme, which guaranteed employees in the automobile industry a certain number of paid hours of work per week irrespective of hours actually worked). Massive job cuts were, however, at the heart of the 'liberal' adjustment. Nevertheless, even in the UK lay offs are not without any compensation thanks to the legal protection in case of layoffs (Employment Protection Act), backed up by the law on severance pay (Redundancy Payment Act). Adjustments in the various automobile firms were therefore generally negotiated with the labour unions. The most widely used system is redundancy payments which were often increased by the firms. Almost all layoffs were 'voluntary redundancies', i.e., with the consent of the departing worker, and with higher severance pay than the statutory minimum payes in case of involuntary redundancies. But it has been observed that redundancy payments are the least protective measures, and a large part of workers who received these payments continue on to fill

the ranks of the long term unemployed (White, 1983; Rees and Thomas, 1988). Early retirements were also used; they concerned approximately 20 percent of all departures and are to a very large extent paid for by company pension funds (Campbell, 1992).

Some companies (British Leyland, Vauxhall, Ford) attempted retraining programs, which have led some authors to draw parallels between the British automobile industry employment market and the German concept of 'internal markets' (Marsden et al., 1985).

However, the adjustment was carried out more rapidly (e.g., 130,000 job cuts in 1980/81 alone) and with less protection than in Germany, Sweden or France. This is obviously linked to the very different need to make adjustments due to very low productivity; during the 70's, the labour unions practiced 'labour hoarding': their splintered organisation and attitude of opposition to change sometimes impeded the internal adjustments required. This has changed since, and there is a current renewal of industrial relations (e.g., single union deal, single status) coming from the transplants, which offer a certain degree of employment security for their employees. This renewal became widespread and is taken up by other companies (such as Rover) as well.

The government as an adjustment agency? In France, employment fared better during the 70s but job cuts increased after the second oil crisis. The management of job cuts has become a major issue. Despite the fact that the labour union membership rate is now the lowest of all European countries, labour unions are not powerless. The government, which plays a more important role in industrial relations and industrial modernisation than in the other countries, has made a fairly wide range of adjustment measures available to companies and individuals (such as short-time work, special in-plant placement, training and especially early retirement). It is true that the French automobile industry uses fixed term contracts and temporary employment more than other countries, to counterbalance swings in production and the external adjustment policy is also based on the departure of immigrant workers. But more than in other countries it is reliant on 'age measures' (e.g., it has been estimated that the costs to the French state for early retirement at Peugeot SA alone, amounted to more than 2 billion francs over a ten-year period – Gerpisa, 1994). But this exit management, through the early retirement of older workers, was gradually slowed due to its cost to the government; the loss of experienced workers for the companies; and by efforts to introduce a system of preventive employment management and exit management based on training. In fact, the 'retraining' policy has become one of the key aspects of employment policy in the 80s (Villeval, 1991; Ardenti and Vrain, 1988), which demonstrates the government's wish

to support companies in their adjustment programmes without footing the entire bill. The relative weakness of labour unions, a gradual change of their policy towards more cooperative models, and a corporate strategy to improve 'out-placement' using external labour market management tools financed in part by the government, have led to a relative consensus on the need to cut jobs to increase productivity in the face of competition.

3.5 Employment security, cooperation and internal change

Our initial hypothesis was that employment security, one of the aspects of the Japanese model, would make adapting to internal structural changes easier. It seems that in Sweden and Germany, during the 80s, the state of the market, the strength of labour unions and the institutional support of internal markets protected jobs, but did not stop external adjustments (because of a fairly high degree of labour mobility) when needed. They also made internal change easier, such as the introduction of new technologies, group work, work time flexibility and even 'just in time'. However, the type of changes introduced were usually more 'human centred' as with the lean production concept. Even when systematic comparative data for 'qualitative' internal adjustments are not available, many authors have shown how extensive the changes are in these two countries, sometimes introduced in different ways (Berggren, 1991; Turner and Auer, 1992; Auer and Riegler, 1990). The familiar changes in work organisation at Volvo, as well as the introduction of group work and flexible hours to increase the operating time of equipment in German plants (Muster, 1988; Lehndorff, 1991), illustrate this fact. In comparison, difficulties are greater in other countries, such as those demonstrated by Pontusson (1991), in his comparison between Sweden and the UK. Other studies (Bouche et al., 1992) show the difficulties of modernisation in France as well.

4. Will yesterday's strengths be tomorrow's weaknesses?

The emergence of the Japanese production method and the recession has suddenly cast doubts, not only on the viability of the kind of European style organisational change (the Volvo approach but also the German style group work supported by the unions provides an illustration of European style approach) but also in general of the socio-economic model dominant mainly in 'neo-corporatist' European countries.

It is true that such European models of work organisation change, as at Uddevalla and Kalmar – considered as non viable by Womack, Jones and Roos – have been discontinued and production has been recentred at the bigger but traditionally organized plants in Torslanda and Gent. It is also true that managers at the Mercedes plant in Rastatt are worried, and might

ask themselves if they have engaged in the right solutions for the 'most modern' car plant in Europe. Put under pressure of delocalisation, unions have also accepted wage restraint there to attract production of the Mercedes city car.

Furthermore, the high employment levels reached during the last upswing in the German and Swedish automobile industry have been questioned and have already been substantially lowered.

However, beyond what can be seen as normal adjustment in economic troughs, it seems that it is the whole socio-economic model with its labour law regulations, high wage levels and substantial social benefits (and assorted wage and non-wage costs), which was only possible to develop because of strong and participative unions and compromise oriented management, is now blamed to be part of the problem rather than being part of the solution, thus putting a question mark on Streeck's thesis of institutional superiority of these systems.

Put under pressure in an era of supply side economics, deregulation and decentralization, globalized markets, renewed power of employers, the traditional 'neo-corporatist' countries seem to be disadvantaged in relation to more market-oriented economies because of their assumed rigidities. On the other hand, these models have already changed to a substantial degree without scrapping all the socio-economic foundations on which they are based. And, as the recent bargaining agreement at Volkswagen has shown, there seems to be a potential for innovative solutions even in such large 'neo-corporatist' firms known for the power of their unions. And also the 'employment oriented' collective bargaining arrangements in the German metal and chemical industries (providing for working time cuts in order to maintain jobs) show this potential for (bargained) change. Institutional resilience in the face of change is certainly a feature of the German model (see Turner, 1993; Thelen 1993; Auer 1994) and institutional stability might also be seen as an advantage in a time of many changes as it makes behaviour of the actors more predictable and 'path dependent'. And the institutional weaknesses (e.g., the training systems, industrial relations, etc.) of the two other countries have given way to a large body of literature which one should not neglect. In any case, it is certainly too early yet to judge which of the 'models' will be the most viable in the long run: those which have come near to (im)perfect markets or those with an institutional 'filter' providing for bargained and cushioned change.

Even if countries react differently to the present organisational change (e.g., different way of socialising the risk of becoming unemployed) a threat is posed to all the economies of the developed world. All have to cope with shrinking employment levels not only in industry but also in certain parts of the service sector (such as banking and insurance) and most notably also

in the public service sector where up to now employment was created. At least two scenarios are possible (neither of which most become reality): the worst case market driven and the less worse socio-economic scenario.

4.1 The worst case scenario

The defenders of lean production believe that lean organisation will lead to low costs, low prices, will spur demand and increase market shares and will eventually become the weapon to defend European markets against the Japanese. They contend that in any case, if one does not engage in cost efficient lean ways of organisation, one will simply disappear from the market altogether. Employment and production will also be lost totally. In that view, lean production is necessary in order to survive. It is difficult to argue against this.

Yet, if we were to add all our factors cited above together, the developed economies engaging in lean organisation on a large scale (not only in the automobile industry) could face important problems which are difficult to overcome. It will be increasingly hard to find regular replacement jobs for those displaced by structural (also organisational) change. But lean employment levels pose also the problem of financing the welfare state: at a certain point, low employment levels might not any more provide a sufficient base for taxation.

Seen from an employment point of view and in a micro-macro link perspective, the present changes towards 'lean' production and organisation in large sectors of the economy might produce the end of the 'fat years' in the economy. 'Lean' organisational change might be a remedy for individual firms, but on the macro level, it could also be a cause for the deterioration of the economic and social climate in general. More than just a bitter pill to swallow with promising health, the remedy could be poisonous or even kill the patient. Lean production in Europe means cost reduction (Cooke, 1993), and cost reduction means basically 'lean employment'

But the lean approach promotes also a fundamental change in how big corporations are run. Until recently, many corporations were in fact socio-economic entities which integrated economic and social responsibilities. But these responsibilities were embedded in a system that benefited all: the employed benefited because of industrial peace and employment security and high wage levels, while the employers benefited because of the maintenance or expansion of demand. Public budgets financed from tax revenue based on (high) wages served to provide the unemployed with benefits and active labour market policy measures, as well as replacement incomes in the form of retirement benefits or social assistance.

In the European 'lean' world of cost (and employment) reduction, there is not many space left for social responsibility. This could mean that either

the employment and poverty problem is individualised or the state has to take over (e.g., through unemployment benefits and labour market policies) while the tax base is shrinking.

Even on a micro-economic level, a catch-22 situation could develop: organisational change needs the motivation of workers and their acceptance of flexible allocation across functions. In exchange some trade offs have to be offered in order to have not only short-term commitment which might also be reached by the fear of job loss, but also sustained commitment and a cooperative attitude of workers. One could argue that the simple threat of job loss is enough to get all the commitment that one needs and that the stick 'employment uncertainty' is a much better instrument of discipline than the carrot 'employment security'. But as has been shown, even firms not bound to give employment security by a strong labour legislation (e.g., in the US) tend to assure it (Mosley, 1993). It was also demonstrated that tenure and training correlate positively and that a trained workforce is an undisputed asset for firms. From a more theoretical perspective, Williamson (1985) arguments imply that transaction costs (screening, hiring, training, etc.) tend to be higher in labour markets with a high degree of external flexibility. This leads to the conclusion that employment security beside being socially desirable has also economic benefits. And as far as flexibility for adjustment is concerned, labour markets characterised by employment stability have institutional 'puffers' which authorise them to make the necessary adjustment (e.g., employment maintenance measures such as short-time work or adjustment measures such as early retirement).

Today, many European manufacturers have to battle on two fronts: they have to receive consent from their workers for far reaching internal changes but cannot offer employment security anymore. They must consequently find either new ways of employment maintenance (like work sharing) or ways to 'socially cushion' exits from the labour markets.

Of course, it is always tempting in times of recession to engage in worst-case-scenarios much like the 'technology as a job killer argument', or more directly linked to the automobile industry, the pessimistic predictions of the first International Motor Vehicle Programme of the MIT (the one preceding the 'Machine that changed the world'). The programme forecasted the disappearance of many major automobile producers (Altshuler, 1984).

Far from behaving as 'lean organisation Luddites', we think it is important to point out the fact that it is today the combination of different elements (lean organisation, high mass unemployment, depleted public funds, slow employment growth in the service sector, etc.) which give alarmist arguments some legitimacy.

4.2 What can be done: a socio-economic scenario

It seems unrealistic to assume that the employment levels reached in the automotive industry in countries like Sweden or Germany can be maintained. Jobs will be lost, as is the usual case during phases of structural change. In that respect, instability is the only stability we can really be sure of.

However, the automotive industry, as well as other industries, should not push for a total cost reduction approach and the leanest of all worlds. Instead of a maximum in leanness, which might lead internally to fragile organisations and externally to a downward spiral in the economies, an optimum in leanness is required. Acceptance of some 'slack' in the production flow as well as in the labour force might be functional for organisational and economic 'safety' alike. Just as a second break fluid circuit in cars (or a reserve computer system in airplanes) is functional for traffic safety while being 'redundant'. In general, one has to ask if some 'redundancies' in the production systems (such as puffers, reserve equipment and reserve labour and/or skills) which from a cost perspective are considered wasteful and not a necessity maintain in fact production flows (see Grabher, 1994).

It might even be better to pay for products a little bit more (add if you wish a 'fat production premium'), but be aware that the organisation and the entire economy benefits from it. A byproduct of such a 'welfare' price approach is a high level of employment, high wages, a high standard of social protection (all supporting demand for goods and services) and sound 'humane' work organisation, which enhances the quality of life.

This does not mean that one should strive for inefficiency, but for gradual adjustment to a reasonable level of efficiency, one which leaves room for some 'waste'. Again, this is not argued solely on social grounds, but in socio-economic terms.

In a totally competitive world, such a gradual adjustment seems impossible, as some players might get lean and displace those who are less lean. Therefore, a corollary for a reasonably efficient economy is not to engage in a totally competitive world. This of course cannot be done on a national level alone but requires cooperation between countries and a sort of bargained or 'managed trade'. This managed trade could simply consist in the regulation of at least minimum standards of social protection, working life or environmental standards which must be fulfilled by all producer countries. This would also help to prevent one country from 'hoovering' over production and jobs from another country by social or environmental dumping.

In view of the Japanese advances this socio-economic approach might be interpreted as leading to the death of all other producers. And yet, even Japan will have to change in the coming years under pressure from new generations, which are not the 'worker bees' their fathers were. Japanese manufacturers adapt their leanest systems to new social demands (Nomura,

1993). Some social adjustments will be needed in this system, which will bring it closer to the European and American automobile industries. In Japan (e.g., Toyotas newest plant), some elements of the European model are integrated, where instead of targeting at a maximum in leanness, they are reintroducing such 'wastes' as puffers between work stations, thereby reducing negative consequences for production flows and worker's health. These developments show that there is indeed a possibility for change which integrates the economic as well as the social dimension.

It is clear, however, that the maintenance (in the European case) or the reintroduction (in the Japanese case) of some 'fat' in production and the economy in general is firmly opposed by those who want to introduce lean production. Therefore some additional remarks have to be made. Our argument is that if lean forms of organisation are adopted to any significant extent, their macro-economic consequences will threaten – by complex effects in the economic process – the foundations of the economy itself. This has to do with micro-macro link questions and also with supply and demand factors. To give a very simple example: in an isolated supply side micro-economic view, high wages are a cost factor which affect competitiveness and destroy jobs. In a demand side macro-economic view, high wages are a benefit to the economy. This is because they spur demand and production and contribute, all other things remaining equal, to the creation of jobs. The dilemma cannot be solved by relying on isolated policies for either side, but by a combined supply/demand and micro/macro policy. The fear is that lean production is just such an isolated supply side micro-economic mechanism, which does not take into account demand aspects (more jobs equal more purchasing power, less public deficits, etc.).

However, in a time of rising unemployment, one has also to question the notion of full employment, as it seems that full employment (full-time jobs with long working hours), can not longer be provided by the advanced industrial countries, and a new more flexible definition for full employment has to be found. Some authors argue that the message of lean ways to organize production is a positive one: more wealth can be produced with less human labour. Despite all the alarmist scenarios of future labour markets, productivity advances make the 'cake' of wealth constantly bigger. It is the cake of work which is shrinking. Yet if one is to engage in work sharing on a large scale, one could distribute smaller slices of the work cake to more people while maintaining or often increasing the wealth cake. This scenario of large scale job sharing to overcome the employment crisis is today believed by a growing number of authors (e.g., Aznar, 1993; Gorz, 1986). It is also applied (not as a clear cut strategy, however) through extending the share of part-time jobs, work time reductions and leave (training, sabbaticals) schemes. Even if work sharing is only one of the possible solutions

for the present employment crisis, it is worth trying it. And one should not forget that new social demands have always been important driving forces for economic development.

Note

1. Regression coefficients show that over the whole period around 75 percent of the variation in production is 'explained' by employment variation in Germany and 60 percent in Sweden, but only 10 percent in France and 20 percent in the UK. In other words: production and employment is much closer linked in Germany and Sweden than in the UK and France. Productivity (production per head) has strongly increased in the UK and also in France, and has been rather stable in Germany, while it has decreased in Sweden till 1991. It is on the rise in all countries since 1991.

References

- Altshuler, A. et al. (1984), *The Future of the Automobile*, The report of MIT's International Automobile Programme, London.
- Ardenti, R.; Vrain, P. (1988), *Les restructurations dans les grandes entreprises: politiques de recomposition de la main d'oeuvre et plans sociaux d'accompagnement des suppressions d'emploi*, Dossier de Recherches no. 24, Centre d'Etudes de l'Emploi, Paris.
- Auer, P. (1994), 'Japan at the Crossroads', *inforMISEP – Politiques*, No. 45, Spring 1994
- (1994), 'Industrial Stability in Changing Environments', in Lansbury, R. (ed), *Managing Together? Consultation and Participation in the Workplace* (forthcoming)
- (ed) (1992), *Workforce Adjustment Patterns, Experiences in the Steel and Automobile Industry*, European Commission, Brussels
- Auer, P.; Büchtemann, C.F. (1990), 'La dérégulation du droit du travail: le cas de la libéralisation du recours aux contrats de travail à durée déterminée. L'expérience de l'Allemagne fédérale et de la France', in Auer, P.; Maruani, M.; Reynaud, E. (eds), *Chroniques internationales du marché du travail et des politiques d'emploi 1986–1989*, La Documentation Française, Paris
- Auer, P.; Riegler, C. (1990), *Post-Taylorism: The Enterprise as a Place of Learning Organisational Change*, Stockholm
- Aznar, G. (1993), *20 propositions pour redistribuer l'emploi*, Paris
- Berggren, Ch. (1991), *Von Ford zu VOLVO*, Springer Verlag, Berlin
- Bouche, G.; Charpentier, P.; Lallemand, C.; Martin, C.; Tonneau, D. (1992), *Réussir une organisation en juste-à-temps*, Editions de l'ANACT, Montrouge
- Büchtemann, C.F.; Meager, N. (1991), *Leaving Employment: Patterns in Major EC Countries*, Discussion Paper FSI 91-10, Wissenschaftszentrum Berlin für Sozialforschung, Berlin

- Campbell, A. (1992), 'The battleground approach to workforce adjustment: United Kingdom', in Auer, P. (ed), *Workforce Adjustment Patterns, Workforce Adjustment Patterns, Experiences in the Steel and Automobile Industry*, European Commission, Brussels
- Comité des Constructeurs Français d'Automobiles (CCFA) (1992), *Rapport annuel*
- Commissariat Général du plan (1992), *Automobile, l'Avenir d'une Industrie en Mutation*, Paris
- Cooke, P. (1993), 'The experiences of German engineering firms in applying lean production methods', in: ILO (ed), *Lean Production and Beyond*, Geneva
- Europäische Kommission (1990), 'Industrieller Strukturwandel im Europäischen Binnenmarkt: Anpassungsbedarf in den Mitgliedstaaten', *Europäische Wirtschaft*, Sondernummer der Kommission der Europäischen Gemeinschaft, Luxemburg
- (1993), *Grünbuch über die europäische Sozialpolitik, Weichenstellung für die Europäische Union*, Kommission der Europäischen Gemeinschaft, Luxemburg
- Financial Times*, Survey (8 September 1993), 'World car industry'
- GERPISA (1994), 'Des Trajectories des Firmes aux modèles industriels', *GERPISA*, réseau international no. 10, Evry
- Gorz, A. (1986), 'Qui ne travaille pas mangera quand même', *Futuribles*, no. 101, juillet-août
- Grabher, G. (1994), *Lob der Verschwendung, Redundanz in der Regionalentwicklung: Ein sozio-ökonomisches Plädoyer*, edition sigma, Berlin
- Inagami, T. (1988), *Japanese Workplace Industrial Relations*, Japanese Industrial Relations Series No. 14, Japan Institute of Labour, Tokyo
- International Labour Office (1993), *Lean Production and Beyond, Labors aspects of a new production concept*, Geneva
- JAMA (1993), Japanese Auto Manufacturing Association, data provided from Brussels office
- Jürgens, V. (1993), 'Lean Production and Co-determination: The German Experience', conference paper, Labor Studies Center, Wayne State University, Detroit
- Kern, H.; Schumann, M. (1984), *Das Ende der Arbeitsteilung? Rationalisierung in der Industriellen Produktion*, München
- Lecler, Y. (1992), 'Les relations inter-entreprises et la flexibilité du travail, le cas du Japon', GERTTD (ed), *La Place du Système d'Emploi et des Relations Industrielles dans la Dynamique de l'Economie Japonaise*, Paris.
- Lehndorff, St. (1991), *Working and Operating Hours in the European Car Industry*, IAT, Gelsenkirchen
- Marsden, D.; Morris, T.; Willman, P.; Wood, S. (1985), *The Car Industry: Labour Relations and Industrial Adjustment*, London, Tavistock
- Mosley, H. (1993), 'Employment Protection in Europe', *inforMISEP – Policies*, No. 44, Winter 1993
- Muster, M. (1988), 'Zum Stand der Gruppenarbeit in der Automobilindustrie in der Bundesrepublik', in Roth, S.; Kohl, H. (eds), *Perspektive Gruppenarbeit*, Bund Verlag, Köln

- Nomura, M. (1993), 'Farewell to 'Toyotisme'? Recent Trend of a Japanese Automobile Company', in *GERPISA*, Des réalités du Toyotisme, actes du GER-PISA, no. 6, Paris
- Pontusson, J. (1990), 'The Politics of New Technology and Job Redesigning: A Comparison of Volvo and British Leyland', *Economic and Industrial Democracy*, Vol. 11
- Rees, W.; Thomas, R.B. (1988), *Readaption Aids in the Coal and Steel Industries*, Commission of the European Communities, Brussels
- Riegler, C. (1992), 'Workforce Adjustment and Labour Market Policy in Sweden', in Auer, P. (ed), *Workforce Adjustment Patterns, Experiences in the Steel and Automobile Industry*, European Commission, Brussels
- Semlinger, K. (1991), 'Workforce Adjustment in a Cooperative Institutional Setting', in Auer, P. (ed), *Workforce Adjustment Patterns in Four Countries: Experiences in the Steel and Automobile Industry in France, Germany, Sweden and the United Kingdom*, Discussion paper FSI 91-4, Wissenschaftszentrum Berlin für Sozialforschung, Berlin
- Streeck, W. (1991), 'On the Institutional Conditions of Diversified Quality Production', in Matzner, E.; Streeck, W., *Beyond Keynesianism*, Elgar, Aldershot
- Thelen, K. (1991), *Union of Parts. Labor Politics in Postwar Germany*, Cornell University Press, New York
- Thorsrud, R.; Emery, F. (1964), *Mot en ny bedriftsorganisasjon* (Towards a New Corporated Organisation), Oslo
- Trist, E.L.; Bamforth, K.W. (1951), 'Some Social and Psychological Consequences of the Longwall Method of coal Getting', *Human Relations*, Vol. 4
- Turner, L. (1992), *Institutional Resilience in a Changing World Economy: German Unions between Unification and Europe*, Discussion paper FSI 92-6, Wissenschaftszentrum Berlin für Sozialforschung, Berlin
- Turner, L.; Auer, P. (1992), *The Political Economy of New Work Organisation: Different Roads, Different Outcomes*, Discussion Paper FS I 92-4, Wissenschaftszentrum Berlin für Sozialforschung, Berlin
- Verband der Deutschen Automobilindustrie (1992), *Das Automobil in Zahlen*.
- Villeval, M.C. (1991), 'The reconversion is dead, long life the reconvertability: the French experience', paper for the Arab regional conference on human resource development, Dubai
- Volvo, *Annual Report* (several years)
- Williamson, O. (1985), *The Economic Institutions of Capitalism*, Free Press, New York
- White, M. (1983), *Long-Term Unemployment and Labour Markets*, Report 622, Policy Studies Institute
- Womack, J.P., Jones, D.T.; Roos, D. (1990), *The Machine that Changed the World*, Ranson Associates, New York